

**P**

**Paulmann**



**2017 / 2018**



--	--	--	--	--	--	--	--	--	--

Customer number / No del cliente / Codice cliente

We provide our products and services in accordance with our terms and conditions of payment and delivery. You can get them on request or with [www.paulmann.com](http://www.paulmann.com)

Todo pedido implica la aceptación de nuestras condiciones de pago y suministro. Nos las puede solicitar o ver en [www.paulmann.com](http://www.paulmann.com)

Lavoriamo sulla base delle nostre condizioni di fornitura e di pagamento. Queste sono disponibili su richiesta all'indirizzo [www.paulmann.com](http://www.paulmann.com)

006	Living area luminaires Lámparas para el hogar Luci per locali abitativi	
088	Galeria	
098	Spotlights	
114	Wire Systems	
132	Rail Systems	
174	Function	
239	Outdoor	
266	Downlights	
386	SmartHome	
404	Lighting control/transformers Control de luz/Transformadores Controllo dell'illuminazione/Trasformatori	
415	LED bulbs Medio de iluminación LED Mezzi d'illuminazione a LED	
453	Energy-saving/fluorescent bulbs Lámparas fluorescentes/de bajo consumo Lampade a risparmio energetico/lampade fluorescenti	
459	Halogen lamps 12V Lámparas halógenas de 12V Lampade alogene da 12V	
463	Halogen lamps 230V Lámparas halógenas de 230V Lampade alogene da 230V	
470	Conventional light bulbs Medios de iluminación convencionales Lampade convenzionali	
478	Technical information, indexes Información técnica, listas Informazioni tecniche, elenchi	

## All about light

Paulmann Licht GmbH, located in Springe in Lower Saxony (Germany), offers over 2500 innovative products; as one of the leading manufacturers in the light industry, we are able to share our expertise – from lights and lighting systems to a complete bulb assortment with many speciality lamps.

Paulmann products are appealing to your customers with light for a cosy ambiance in modern design and energy efficiency.

Sales offices and agencies in 40 countries of Europe ensure that customers receive direct, local support.

## Todo alrededor de la luz

Paulmann Licht GmbH con sede en Springe, Baja Sajonia (Alemania), es, con sus más de 2500 productos innovadores, uno de los proveedores líderes en el sector de luminarias y ofrece soluciones competentes para toda la gama de productos: desde lámparas y sistemas de iluminación hasta un surtido completo de luminarias con muchas especialidades.

Los productos Paulmann entusiasman a sus clientes por su luz agradable, diseño actual y alta eficiencia energética.

Gracias a nuestras sucursales y representaciones en más de 40 países de Europa, los clientes reciben un asesoramiento individual y sin desplazamientos.

## Tutto per la luce

Con oltre 2500 prodotti innovativi Paulmann Licht GmbH, che ha sede a Springe (Bassa Sassonia, Germania), è uno dei fornitori leader nel settore dell'illuminazione. Le sue competenze coprono l'intero assortimento: dai singoli apparecchi ai sistemi d'illuminazione fino a un assortimento completo di lampadine che vanta prodotti esclusivi.

I prodotti Paulmann soddisfano i clienti con la loro luce per il benessere, il design moderno e l'elevata efficienza energetica.

Grazie alle nostre filiali e rappresentanze in più di 40 Paesi europei, i clienti possono usufruire di un'assistenza individuale direttamente in loco.

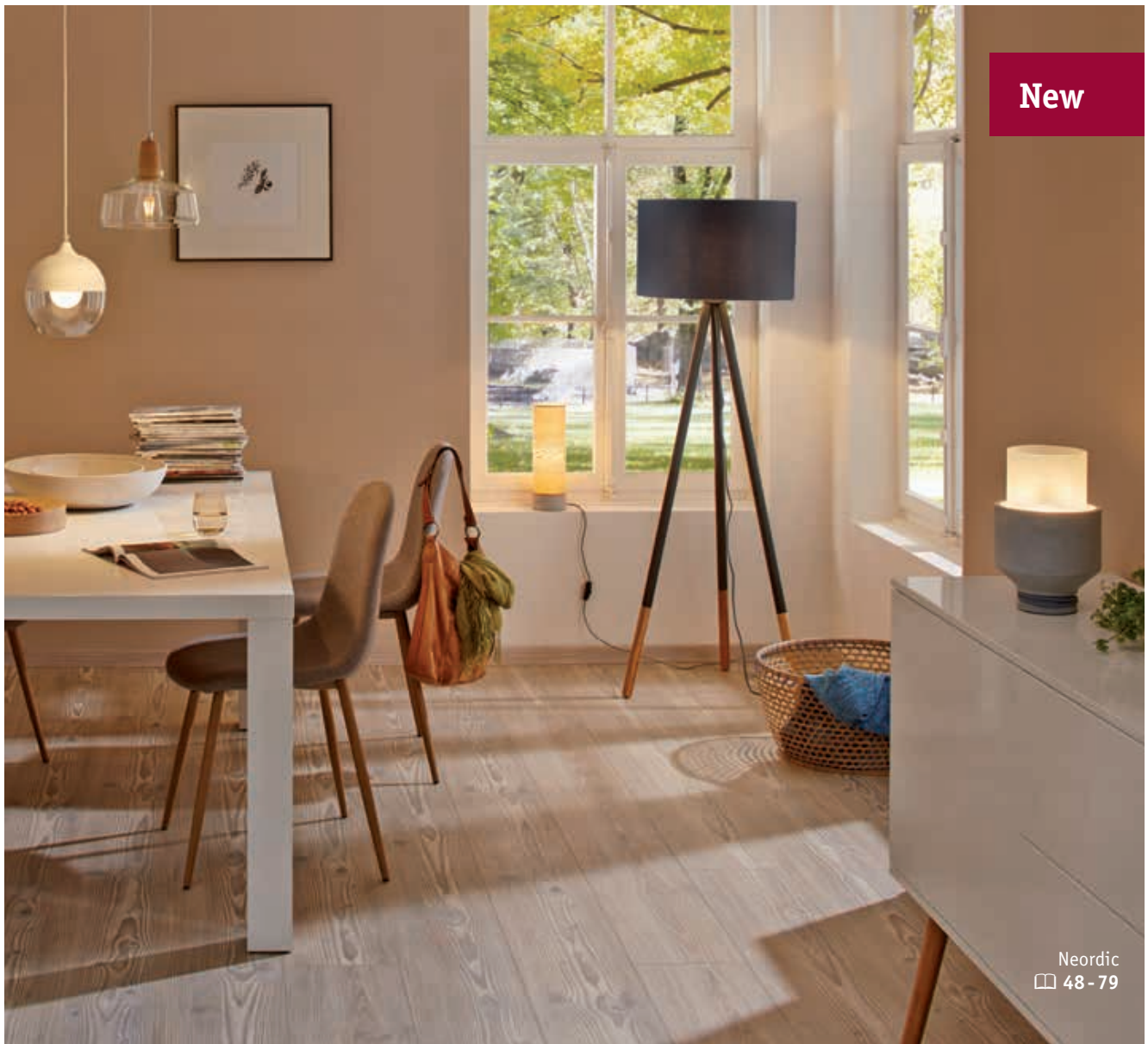





**New**

Rail Systems  
URail Ceiling Globe  
□ 136 + 134



**New**

Rail Systems  
URail Pendulum Capsule II  
□ 145



**New**

Function  
Step Profil  
□ 219





**New**

Downlights  
Premium Drip  
☐ 310



LED  
Filament  
☐ 440 + 446



**New**

Wall & Ceiling  
Bar  
☐ 21



**New**



Paulmann  
Home



Smarthome  
☐ 386 - 403



**New**

Downlights  
□ 266 - 385



**New**

Downlights  
Star Frill LED  
□ 332



**New**

Rail Systems  
URail LED Y-Connector  
□ 134



**New**

Rail Systems  
URail Wall Spot Torch  
□ 138



**New**

Wall & Ceiling  
Atria  
□ 12

## Wall & Ceiling

- 07 PadLED
- 24 Bathroom

## Living room

- 48 Neordic
- 80 OLED
- 81 Table



12 Atria



36 Capella



18 Decobeam



48 Neordic





#### PadLED lighting system for virtually invisible cable installation

In many rooms, factors such as concrete ceilings prevent the use of recessed lighting. The PadLED system provides a bright alternative with a contemporary design. A thumb's width of ultra-flush cable connecting the magnetically attached spot pads can easily be glued to the ceiling and is rendered virtually invisible by wallpapering or painting over the area.

- ▶ Extremely flush surface-mounting of the lights, even on cement ceilings
- ▶ Easy installation via a self-adhesive connecting cable
- ▶ A thumb's width of ultra-flush connecting cable – rendered virtually invisible by wallpapering or painting
- ▶ Installation length of up to eight metres
- ▶ Warm white luminous colour (2700 kelvin)
- ▶ Efficient LED system with energy savings of up to 80%

#### PadLED - Sistema de iluminación para un cableado casi invisible

En muchos espacios no es posible usar lámparas empotrables, por ejemplo cuando el techo de hormigón no lo permite. Una brillante alternativa es el sistema PadLED en estilo de diseño moderno. un cable de conexión del ancho de un pulgar, ultraplano entre las bases de focos fijadas magnéticamente, se pega fácilmente en el techo y mediante papel pintado o pintura queda prácticamente invisible.

- ▶ Construcción extremadamente plana en techos de hormigón
- ▶ Fácil montaje con cable de conexión autoadhesivo
- ▶ Cable de conexión ultraplano del ancho de un pulgar; queda invisible con papel pintado o pintura
- ▶ Hasta ocho metros de tendido
- ▶ Luz de color blanco cálido (2700 kelvin)
- ▶ Sistema de LED eficiente, ahorra hasta un 80% de energía

#### PadLED - Sistema di illuminazione con una posa dei cavi quasi invisibile

In molti ambienti non è possibile impiegare faretti a incasso, ad esempio se i soffitti sono in calcestruzzo. Un'alternativa è il brillante sistema PadLED, dal piacevole design moderno. Un cavo di collegamento ultrapiatto largo un pollice che collega gli spot pad a fissaggio magnetico può essere incollato al soffitto: una volta dipinto o tappezzato, è praticamente invisibile.

- ▶ Struttura estremamente piatta delle luci anche su soffitti in calcestruzzo
- ▶ Semplice montaggio grazie al cavo di collegamento autoadesivo
- ▶ Cavo di collegamento ultrapiatto largo un pollice: una volta dipinto o tappezzato, è praticamente invisibile
- ▶ Possibilità di prolunga fino a otto metri
- ▶ Colore della luce bianco caldo 2.700 Kelvin
- ▶ Efficiente sistema LED per il risparmio di fino all'80% di energia



Chrome matt/Chrome  
 Cromo mate/Cromo  
 Cromo opaco/Cromo

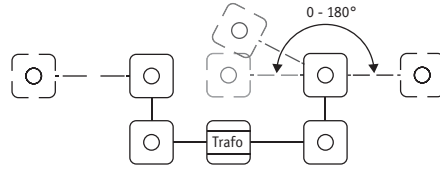

PadLED 952.24 + 2x PadLED Extension 952.25



**PowerPad Set**

A++-A

incl. 4x10 W  
 4x427 lm, 2.700 K  
 <math>\angle 120^\circ</math>  
 230 V, incl.  $\text{---}$  2x30 VA  
 $\updownarrow 50 \text{ mm}$   $\leftrightarrow 155 \text{ mm}$   $\nearrow 155 \text{ mm}$   
 $\leftrightarrow 8 \text{ m}$   
 EAN 4000870 952245  
**952.24**

LED



Chrome matt/Chrome  
 Cromo mate/Cromo  
 Cromo opaco/Cromo

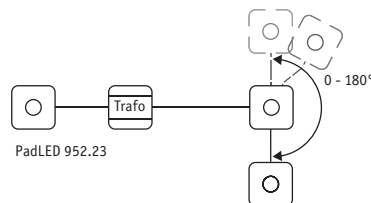

PadLED 952.23

**PowerPad Set**

A++-A

incl. 3x10 W  
 3x427 lm, 2.700 K  
 <math>\angle 120^\circ</math>  
 230 V, incl.  $\text{---}$  30 VA  
 $\updownarrow 50 \text{ mm}$   $\leftrightarrow 155 \text{ mm}$   $\nearrow 155 \text{ mm}$   
 $\leftrightarrow 6 \text{ m}$   
 EAN 4000870 952238  
**952.23**

LED



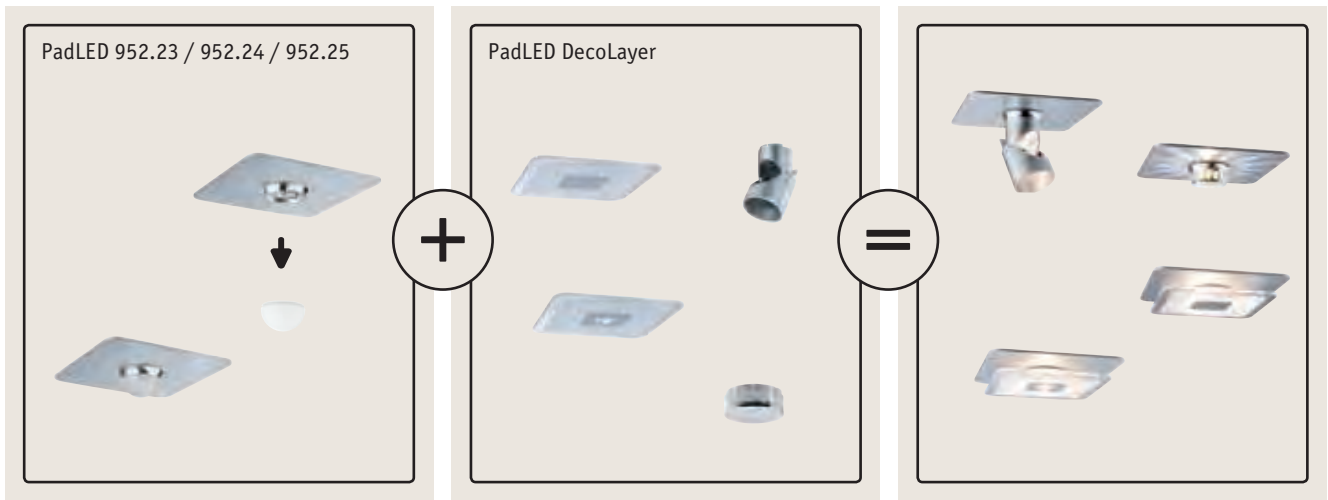

incl. 1 x 2m



**PowerPad**

incl. 1x10 W  
 427 lm, 2.700 K  
 <math>\sphericalangle</math> 120°  
 230 V  
 <math>\varnothing</math>50 <math>\leftrightarrow</math>155 <math>\varnothing</math>155 mm  
 EAN 4000870 952252  
**952.25**  
 Chrome matt/Chrome  
 Cromo mate/Cromo  
 Cromo opaco/Cromo



**DecoLayer Sunray**

<math>\varnothing</math>16,3 <math>\varnothing</math>41,4 mm  
 EAN 4000870 952214  
**952.21**  
 Chrome matt  
 Cromo mate  
 Cromo opaco



**DecoLayer Downlight**

<math>\varnothing</math>25,3 <math>\leftrightarrow</math>131 <math>\varnothing</math>131 mm  
 EAN 4000870 952221  
**952.22**  
 Chrome matt  
 Cromo mate  
 Cromo opaco



**DecoLayer Diffuse**

<math>\varnothing</math>14 <math>\leftrightarrow</math>130 <math>\varnothing</math>130 mm  
 EAN 4000870 952269  
**952.26**  
 Chrome matt  
 Cromo mate  
 Cromo opaco

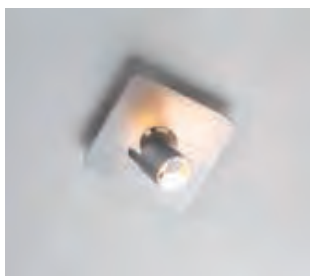

**DecoLayer Pitch**

<math>\varnothing</math>65 <math>\leftrightarrow</math>50 <math>\varnothing</math>85 mm  
 EAN 4000870 952849  
**952.84**  
 Chrome matt  
 Cromo mate  
 Cromo opaco





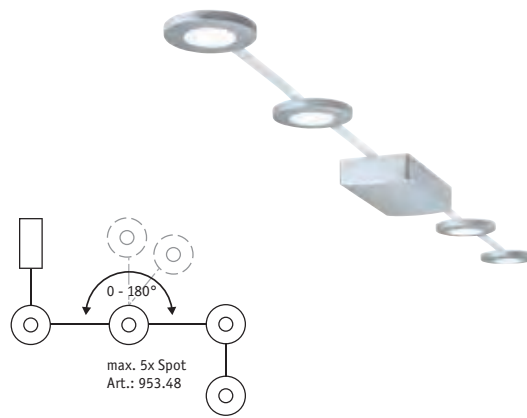

**EcoPad Round** A++-A  
 incl. 4x2,2W LED  
 4x238 lm, 2.700 K  
 230/12V, incl.  $\pm$ 15 VA □  
 ⇔5 m  
 EAN 4000870 953471  
**953.47** new

- ☞ Chrome matt  Plastic
- ☞ Cromo mate  Plástico
- ☞ Cromo opaco  Plastica

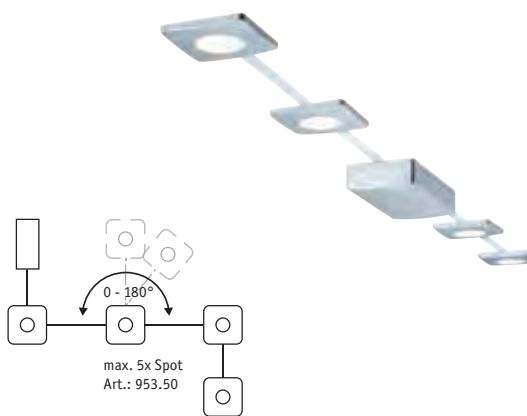

**EcoPad Square** A++-A  
 incl. 4x2,2W LED  
 4x238 lm, 2.700 K  
 230/12V, incl.  $\pm$ 15 VA □  
 ⇔5 m  
 EAN 4000870 953495  
**953.49** new

- ☞ Chrome matt  Plastic
- ☞ Cromo mate  Plástico
- ☞ Cromo opaco  Plastica



**EcoPad Round** A++-A  
 incl. 1x2,2W LED  
 238 lm, 2.700 K  
 12V ◊  
 $\hat{H}$ 12  $\hat{D}$ 90 mm  
 EAN 4000870 953488  
**953.48** new  
 ☞ Chrome matt  Plastic  
 ☞ Cromo mate  Plástico  
 ☞ Cromo opaco  Plastica

**EcoPad Square** A++-A  
 incl. 1x2,2W LED  
 238 lm, 2.700 K  
 12V ◊  
 $\hat{H}$ 12  $\hat{D}$ 90 mm  
 EAN 4000870 953501  
**953.50** new  
 ☞ Chrome matt  Plastic  
 ☞ Cromo mate  Plástico  
 ☞ Cromo opaco  Plastica

**Cable 5m** A++-A  
LED  
 $\hat{D}$ 15 mm  $\hat{L}$ 5 m  
 EAN 4000870 950814  
**950.81**  
 ☞ White  
 ☞ Blanco  
 ☞ Bianco



Chrome matt Plastic  
 Cromo mate Plástico  
 Cromo opaco Plastica



**Atria** A++-A  
 incl. 1x18,5 W  
 1.500 lm, 2.700 K  
 230 V  
 ⌀20 ø220 mm  
 EAN 4000870 708644  
**708.64 new**



**Atria** A++-A  
 incl. 1x22 W  
 1.800 lm, 2.700 K  
 230 V  
 ⌀20 ø300 mm  
 EAN 4000870 708651  
**708.65 new**



Chrome matt Plastic  
 Cromo mate Plástico  
 Cromo opaco Plastica



**Atria** A++-A  
 incl. 1x20 W  
 1.500 lm, 2.700 K  
 230 V  
 ⌀20 ⇔220 ↗220 mm  
 EAN 4000870 708668  
**708.66 new**



**Atria** A++-A  
 incl. 1x24 W  
 1.800 lm, 2.700 K  
 230 V  
 ⌀20 ⇔300 ↗300 mm  
 EAN 4000870 708675  
**708.67 new**



Matt white Plastic  
 Blanco mate Plástico  
 Bianco opaco Plastica



**Atria** A++-A  
 incl. 1x18,5 W  
 1.500 lm, 2.700 K  
 230 V  
 ⌀20 ø220 mm  
 EAN 4000870 708682  
**708.68 new**



**Atria** A++-A  
 incl. 1x22 W  
 1.800 lm, 2.700 K  
 230 V  
 ⌀20 ø300 mm  
 EAN 4000870 708699  
**708.69 new**





- 🌀 Matt white 🏠 Plastic
- 🌀 Blanco mate 🏠 Plástico
- 🌀 Bianco opaco 🏠 Plastica



**Atria** A++-A  
 incl. 1×20 W  
 1.500 lm, 2.700 K  
 230 V  
 ⌀20 ⇄220 ↗220 mm  
 EAN 4000870 708705  
**708.70 new**

LED

incl.



**Atria** A++-A  
 incl. 1×24 W  
 1.800 lm, 2.700 K  
 230 V  
 ⌀20 ⇄300 ↗300 mm  
 EAN 4000870 708712  
**708.71 new**

LED

incl.



- 🌀 Rosé gold 🏠 Plastic
- 🌀 Oro rosa 🏠 Plástico
- 🌀 Oro rosa 🏠 Plastica



**Atria** A++-A  
 incl. 1×22 W  
 1.800 lm, 2.700 K  
 230 V  
 ⌀20 ⌀300 mm  
 EAN 4000870 708729  
**708.72 new**

LED

incl.



- 🌀 Rosé gold 🏠 Plastic
- 🌀 Oro rosa 🏠 Plástico
- 🌀 Oro rosa 🏠 Plastica



**Atria** A++-A  
 incl. 1×24 W  
 1.800 lm, 2.700 K  
 230 V  
 ⌀20 ⇄300 ↗300 mm  
 EAN 4000870 708736  
**708.73 new**

LED

incl.







- ☞ Chrome matt ☒ Aluminium
- ☞ Cromo mate ☒ Aluminio
- ☞ Cromo opaco ☒ Alluminio



**Lunar** A++-A  
 incl. 1×11 W LED  
 1.230 lm, 3.000 K  
 230 V, incl.  $\text{⊖}$  12,6 VA ☐  
 ø170 ↗38 mm  
 EAN 4000870 706534  
**706.53**



**Lunar** A++-A  
 incl. 1×15 W LED  
 1.520 lm, 3.000 K  
 230 V, incl.  $\text{⊖}$  19,2 VA ☐  
 ø225 ↗38 mm  
 EAN 4000870 706541  
**706.54**



**Lunar** A++-A  
 incl. 1×17 W LED  
 1.700 lm, 3.000 K  
 230 V, incl.  $\text{⊖}$  19,2 VA ☐  
 ø300 ↗38 mm  
 EAN 4000870 706558  
**706.55**



**Lunar** A++-A  
 incl. 1×21,8 W LED  
 2.400 lm, 3.000 K  
 230 V, incl.  $\text{⊖}$  24,6 VA ☐  
 ø400 ↗39 mm  
 EAN 4000870 706565  
**706.56**



- ☞ Chrome matt ☒ Aluminium
- ☞ Cromo mate ☒ Aluminio
- ☞ Cromo opaco ☒ Alluminio



**Lunar** A++-A  
 incl. 1×11 W LED  
 1.230 lm, 3.000 K  
 230 V, incl.  $\text{⊖}$  12,6 VA ☐  
 ⚡170 ⇄170 ↗38 mm  
 EAN 4000870 706480  
**706.48**



**Lunar** A++-A  
 incl. 1×15,4 W LED  
 1.520 lm, 3.000 K  
 230 V, incl.  $\text{⊖}$  19,2 VA ☐  
 ⚡225 ⇄225 ↗38 mm  
 EAN 4000870 706497  
**706.49**



**Lunar** A++-A  
 incl. 1×18 W LED  
 1.700 lm, 3.000 K  
 230 V, incl.  $\text{⊖}$  19,2 VA ☐  
 ⚡300 ⇄300 ↗38 mm  
 EAN 4000870 706503  
**706.50**



**Lunar** A++-A  
 incl. 1×21,8 W LED  
 2.400 lm, 3.000 K  
 230 V, incl.  $\text{⊖}$  24,6 VA ☐  
 ⚡400 ⇄400 ↗39 mm  
 EAN 4000870 706510  
**706.51**



**Lunar** A++-A  
 incl. 1×27,4 W LED  
 3.050 lm, 3.000 K  
 230 V, incl.  $\text{⊖}$  30,1 VA ☐  
 ⚡600 ⇄600 ↗39 mm  
 EAN 4000870 706527  
**706.52**



Matt white Aluminium  
 Blanco mate Aluminio  
 Bianco opaco Alluminio



**Lunar** A++-A  
 incl. 1x11 W   
 1.230 lm, 3.000 K   
 230 V, incl.  $\text{⊖}$  14,5 VA  
 ø170  $\text{↗}$ 38 mm  
 EAN 4000870 706411  
**706.41**



**Lunar** A++-A  
 incl. 1x15,5 W   
 1.520 lm, 3.000 K   
 230 V, incl.  $\text{⊖}$  17,5 VA  
 ø225  $\text{↗}$ 38 mm  
 EAN 4000870 706428  
**706.42**



**Lunar** A++-A  
 incl. 1x17 W   
 1.700 lm, 3.000 K   
 230 V, incl.  $\text{⊖}$  17,2 VA  
 ø300  $\text{↗}$ 38 mm  
 EAN 4000870 706435  
**706.43**



Matt white Aluminium  
 Blanco mate Aluminio  
 Bianco opaco Alluminio



**Lunar** A++-A  
 incl. 1x11 W   
 1.230 lm, 3.000 K   
 230 V, incl.  $\text{⊖}$  12,6 VA  
 $\text{↕}$ 170  $\text{↔}$ 170  $\text{↗}$ 38 mm  
 EAN 4000870 706442  
**706.44**



**Lunar** A++-A  
 incl. 1x15,4 W   
 1.520 lm, 3.000 K   
 230 V, incl.  $\text{⊖}$  19,2 VA  
 $\text{↕}$ 225  $\text{↔}$ 225  $\text{↗}$ 38 mm  
 EAN 4000870 706459  
**706.45**



**Lunar** A++-A  
 incl. 1x18 W   
 1.700 lm, 3.000 K   
 230 V, incl.  $\text{⊖}$  19,2 VA  
 $\text{↕}$ 300  $\text{↔}$ 300  $\text{↗}$ 38 mm  
 EAN 4000870 706466  
**706.46**



**Lunar** A++-A  
 incl. 1x27,4 W   
 3.050 lm, 3.000 K   
 230 V, incl.  $\text{⊖}$  30,1 VA  
 $\text{↕}$ 600  $\text{↔}$ 600  $\text{↗}$ 39 mm  
 EAN 4000870 706473  
**706.47**



- ☞ Chrome matt/White ☒ Metal/Plastic
- ☞ Cromo mate/Blanco ☒ Metal/Plástico
- ☞ Cromo opaco/Bianco ☒ Metallo/Plastica

**Smooth**

A++-A

incl. 1×7,5 W  
400-500 lm, 2.700 - 6.000 K  
230V, incl. ⚡ 20 VA  
ø210 ↗35 mm  
EAN 4000870 704325

**704.32**

LED

Incl.

☒

Bajonett

**Smooth**

A++-A

incl. 1×11 W  
700-800 lm, 2.700 - 6.000 K  
230V, incl. ⚡ 27,3 VA  
ø300 ↗35 mm  
EAN 4000870 704332

**704.33**

LED

Incl.

☒

Bajonett

**Smooth**

A++-A

incl. 1×13 W  
850-1.000 lm, 2.700 - 6.000 K  
230V, incl. ⚡ 30 VA  
ø360 ↗35 mm  
EAN 4000870 704349

**704.34**

LED

Incl.

☒

Bajonett





- ☞ Chrome matt/White ☒ Plastic
- ☞ Cromo mate/Blanco ☒ Plástico
- ☞ Cromo opaco/Bianco ☒ Plastica



**Orbit**

A++-A

incl. 1x15 W  
760 lm  
230V, incl. ⚡ 20 VA  
ø300 ↗56 mm  
EAN 4000870 704370  
**704.37**



- ☞ Chrome matt/White ☒ Plastic
- ☞ Cromo mate/Blanco ☒ Plástico
- ☞ Cromo opaco/Bianco ☒ Plastica

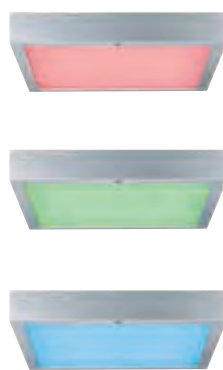

**Space**

A++-A

incl. 1x15,5 W  
800 lm  
230V, incl. ⚡ 20 VA  
↕300 ↔300 ↗56 mm  
EAN 4000870 704387  
**704.38**



- ☞ White ☒ Metal
- ☞ Blanco ☒ Metal
- ☞ Bianco ☒ Metallo



**Sol**

A++-A

incl. 1x4,2 / 1x2,8 W  
440 + 380 lm, 3.000 K  
ø195 ↗40 mm  
EAN 4000870 707357  
**707.35 new**



**Sol**

A++-A

incl. 1x8 / 1x4,2 W  
970 + 445 lm, 3.000 K  
ø245 ↗40 mm  
EAN 4000870 707364  
**707.36 new**





☞ White ☒ Metal  
 ☞ Blanco ☒ Metal  
 ☞ Bianco ☒ Metallo



**Sol** A++-A  
 incl. 1×4,2 / 1×2,8 W  
 558 + 312 lm, 3.000 K  
 ⌀195 ⇄195 ↗40 mm  
 EAN 4000870 707326  
**707.32 new**



**Sol** A++-A  
 incl. 1×8 / 1×4,2 W  
 950 + 440 lm, 3.000 K  
 ⌀245 ⇄245 ↗40 mm  
 EAN 4000870 707333  
**707.33 new**



☞ White ☒ Metal  
 ☞ Blanco ☒ Metal  
 ☞ Bianco ☒ Metallo

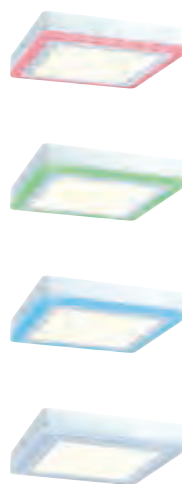

**Sol** A++-A  
 incl. 1×9,4 / 1×4,6 W  
 830 + 100 lm, 3.000 K  
 incl. ⚡ 12 VA  
 ⌀245 ⇄245 ↗40 mm  
 EAN 4000870 707340  
**707.34 new**



☞ White ☒ Metal  
 ☞ Blanco ☒ Metal  
 ☞ Bianco ☒ Metallo

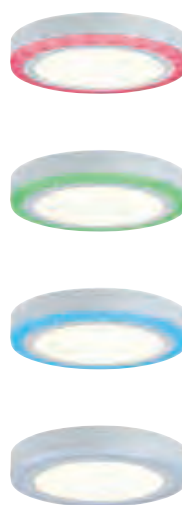

**Sol** A++-A  
 incl. 1×9,4 / 1×4,6 W  
 855 + 85 lm, 3.000 K  
 incl. ⚡ 12 VA  
 ⌀245 ↗40 mm  
 EAN 4000870 707371  
**707.37 new**





270 lm



527 lm



797 lm

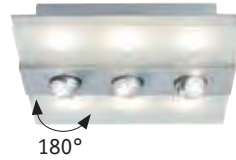

180°

**Xeta-Spot**

A++-A

incl. 1x22,5 W  
3.000 K  
230V, incl.  $\text{⏏}$  15 VA  
 $\text{⌀}$ 320  $\text{⇔}$ 320  $\text{↗}$ 88 mm  
EAN 4000870 702901  
**702.90**

LED



- ☞ Chrome matt  $\text{⏏}$  Metal/Glass
- ☞ Cromo mate  $\text{⏏}$  Metal/Cristal
- ☞ Cromo opaco  $\text{⏏}$  Metallo/Vetro



**Xeta**

A++-A

incl. 1x12,5 W  
600 lm, 3.000 K  
230 V  
 $\text{⌀}$ 300  $\text{⇔}$ 200  $\text{↗}$ 68 mm  
EAN 4000870 701287  
**701.28**

LED



**Xeta**

A++-A

incl. 1x22,5 W  
780 lm, 3.000 K  
230 V  
 $\text{⌀}$ 300  $\text{⇔}$ 300  $\text{↗}$ 68 mm  
EAN 4000870 701294  
**701.29**

LED



- ☞ Chrome matt  $\text{⏏}$  Metal/Glass
- ☞ Cromo mate  $\text{⏏}$  Metal/Cristal
- ☞ Cromo opaco  $\text{⏏}$  Metallo/Vetro



**DecoBeam**

A++-A

incl. 1x2,5 W  
93 lm, 3.000 K  
230 V  
 $\text{⌀}$ 103  $\text{↗}$ 54 mm  
EAN 4000870 702918  
**702.91**

LED



**DecoBeam**

A++-A

incl. 1x3,5 W  
330 lm, 3.000 K  
230 V, incl.  $\text{⏏}$  7 VA  
 $\text{⌀}$ 150  $\text{↗}$ 54 mm  
EAN 4000870 707203  
**707.20** **new**

LED



**DecoBeam**

A++-A

incl. 1x4,5 W  
451 lm, 3.000 K  
230 V, incl.  $\text{⏏}$  7 VA  
 $\text{⌀}$ 250  $\text{↗}$ 54 mm  
EAN 4000870 707210  
**707.21** **new**

LED



- ☞ Chrome/Chrome matt/Transparent  $\text{⏏}$  Metal/Acrylic
- ☞ Cromo/Cromo mate/Transparente  $\text{⏏}$  Metal/Acrílico
- ☞ Cromo/Cromo opaco/Trasparente  $\text{⏏}$  Metallo/Acrilico

**Accento**

incl. 1x22 / 1x3 W  
 2.150 lm, 3.000 - 6.500 K  
 230-240 V  
 ø340 ø85 mm  
 EAN 4000870 706220  
**706.22 new**



A++-A

LED

tunable white

IP44

Sound



- ☞ White ☐ Plastic
- ☞ Blanco ☐ Plástico
- ☞ Bianco ☐ Plastica

**Faccetto**

incl. 2x9 W, E27, A  
 2x513 lm, 2.700 K  
 230 V  
 ø300 ø300 ø110 mm  
 EAN 4000870 700181  
**700.18**

A-A

Energy Saver

IP44

Sound

- ☞ Clear/White ☐ Metal/Glass
- ☞ Transparente/Blanco ☐ Metal/Cristal
- ☞ Trasparente/Bianco ☐ Metallo/Vetro

💡 880.14





⌚ Silver/White ☒ Metal/Acrylic  
 ⌚ Plateado/Blanco ☒ Metal/Acrílico  
 ⌚ Argento/Bianco ☒ Metallo/Acricico

💡 884.47



**Two-Step**

incl. 1×40 W, 2GX13, ⚡ A  
 3.550 lm, 2.700 K  
 230 V  
 ⌀430 ⇄430 ⤴90 mm  
 EAN 4000870 700211  
**700.21**



⌚ Brushed aluminium/White ☒ Aluminium/Acrylic  
 ⌚ Aluminio mateado/Blanco ☒ Aluminio/Acrílico  
 ⌚ Alluminio spazzolato/Bianco ☒ Alluminio/Acricico

💡 884.48



**Bound**

incl. 1×22 W, 2GX13, ⚡ A  
 1.720 lm, 2.700 K  
 230 V  
 ⌀280 ⇄280 ⤴88 mm  
 EAN 4000870 700235  
**700.23**



**Bound**

incl. 1×40 W, 2GX13, ⚡ A  
 3.550 lm, 2.700 K  
 230 V  
 ⌀420 ⇄420 ⤴98 mm  
 EAN 4000870 700242  
**700.24**



⌚ Silver/White ☒ Metal/Acrylic  
 ⌚ Plateado/Blanco ☒ Metal/Acrílico  
 ⌚ Argento/Bianco ☒ Metallo/Acricico

💡 884.48



**Stepino**

incl. 1×22 W, 2GX13, ⚡ A  
 1.720 lm, 2.700 K  
 230 V  
 ø325 ⤴90 mm  
 EAN 4000870 700303  
**700.30**





- 🔗 White 📦 Aluminium
- 🔗 Blanco 📦 Aluminio
- 🔗 Bianco 📦 Alluminio



**Bar** A++-A

incl. 1×5,5 W  
 765 lm, 2.700 K  
 230 V, incl. ⚡ 6 VA  
 ⌀70 ⇔200 ↻100 mm  
 EAN 4000870 707906  
**707.90 new**

LED  
  



- 🔗 Grey/Silver 📦 Aluminium
- 🔗 Gris/Plateado 📦 Aluminio
- 🔗 Grigio/Argento 📦 Alluminio



**Bar** A++-A

incl. 1×5,5 W  
 765 lm, 2.700 K  
 230 V, incl. ⚡ 6 VA  
 ⌀70 ⇔200 ↻100 mm  
 EAN 4000870 707999  
**707.99 new**

LED  
  



- 🔗 White/Gold 📦 Aluminium
- 🔗 Blanco/Oro 📦 Aluminio
- 🔗 Bianco/Oro 📦 Alluminio



**Bar** A++-A

incl. 1×5,5 W  
 765 lm, 2.700 K  
 230 V, incl. ⚡ 6 VA  
 ⌀70 ⇔200 ↻100 mm  
 EAN 4000870 707982  
**707.98 new**

LED  
  



**Bar**

A++-A

incl. 1x10,5 W  
1.500 lm, 2.700 K  
230 V, incl.  $\approx$  12 VA  
 $\varnothing$ 70  $\leftrightarrow$ 400  $\varnothing$ 100 mm  
EAN 4000870 707913

LED



**707.91 new**

- 🔗 White  $\boxtimes$  Aluminium
- 🔗 Blanco  $\boxtimes$  Aluminio
- 🔗 Bianco  $\boxtimes$  Alluminio



**Bocca**

A++-A

incl. 2x3 W  
2x320 + 320 lm, 2.700 K  
230 V, incl.  $\approx$  6 VA  
 $\varnothing$ 100  $\leftrightarrow$ 140  $\varnothing$ 52 mm  
EAN 4000870 707920

LED



**707.92 new**

- 🔗 White  $\boxtimes$  Aluminium
- 🔗 Blanco  $\boxtimes$  Aluminio
- 🔗 Bianco  $\boxtimes$  Alluminio



**Tulip**

A++-A

incl. 1x3 W  
420 lm, 2.700 K  
230 V, incl.  $\approx$  3,6 VA  
 $\varnothing$ 95  $\leftrightarrow$ 140  $\varnothing$ 52 mm  
EAN 4000870 707937

LED



**707.93 new**

- 🔗 White  $\boxtimes$  Aluminium
- 🔗 Blanco  $\boxtimes$  Aluminio
- 🔗 Bianco  $\boxtimes$  Alluminio

**Stadio**

A++-A

incl. 1x5,5 W  
730 lm, 2.700 K  
230 V, incl.  $\text{⚡}$  6 VA  
⌀70 ⇄103 ⌀138 mm  
EAN 4000870 707968

LED



D

**707.96 new**

🌀 White Aluminium  
🌀 Blanco Aluminio  
🌀 Bianco Alluminio

**Anello**

A++-A

incl. 1x6,5 W  
870 lm, 2.700 K  
230 V, incl.  $\text{⚡}$  8 VA  
⌀31 ⇄300 ⌀141 mm  
EAN 4000870 707951

LED



D

**707.95 new**

🌀 White Aluminium  
🌀 Blanco Aluminio  
🌀 Bianco Alluminio

**Scena**

A++-A

incl. 4x2,5 W  
4x330 + 330 lm, 2.700 K  
230 V, incl.  $\text{⚡}$  12 VA  
⌀90 ⇄210 ⌀105 mm  
EAN 4000870 707944

LED



D

**707.94 new**

🌀 White Aluminium  
🌀 Blanco Aluminio  
🌀 Bianco Alluminio







**Ivy** A++-A

incl. 1x14 W  
1.640 lm, 2.700 K  
230V, incl.  $\text{⏏}$  15 VA  
ø300  $\nearrow$ 40 mm  
EAN 4000870 706862  
**706.86**

LED  
IP44  
Bajonett

**Ivy** A++-A

incl. 1x20 W  
2.296 lm, 2.700 K  
230V, incl.  $\text{⏏}$  20 VA  
ø380  $\nearrow$ 40 mm  
EAN 4000870 706879  
**706.87**

LED  
IP44  
Bajonett

- ☞ Chrome matt  $\text{⏏}$  Plastic
- ☞ Cromo mate  $\text{⏏}$  Plástico
- ☞ Cromo opaco  $\text{⏏}$  Plastica



**Ivy** A++-A

incl. 1x14 W  
1.640 lm, 2.700 K  
230V, incl.  $\text{⏏}$  15 VA  
ø300  $\leftrightarrow$ 300  $\nearrow$ 40 mm  
EAN 4000870 706886  
**706.88**

LED  
IP44  
Bajonett

**Ivy** A++-A

incl. 1x20 W  
2.296 lm, 2.700 K  
230V, incl.  $\text{⏏}$  20 VA  
ø380  $\leftrightarrow$ 380  $\nearrow$ 40 mm  
EAN 4000870 706893  
**706.89**

LED  
IP44  
Bajonett

- ☞ Chrome matt  $\text{⏏}$  Plastic
- ☞ Cromo mate  $\text{⏏}$  Plástico
- ☞ Cromo opaco  $\text{⏏}$  Plastica



**Grid** A++-A

incl. 1x10 W  
1.230 lm, 2.700 K  
230V, incl.  $\text{⏏}$  10 VA  
ø240  $\leftrightarrow$ 240  $\nearrow$ 40 mm  
EAN 4000870 706909  
**706.90**

LED  
IP44  
Bajonett

- ☞ Matt white  $\text{⏏}$  Plastic
- ☞ Blanco mate  $\text{⏏}$  Plástico
- ☞ Bianco opaco  $\text{⏏}$  Plastica

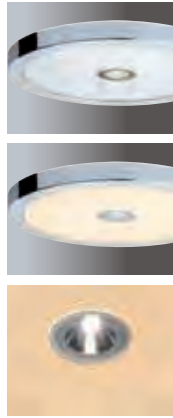

**Beam**

A++-A

incl. 1x13,5 / 1x2 W  
 1.476 + 247 lm, 2.700 K  
 230V, incl.  $\text{⏏}$  20 VA  
 ø300 ↗42 mm  
 EAN 4000870 706923  
**706.92**

LED

IP44



Bajonett

- ☞ Chrome ☒ Plastic
- ☞ Cromo ☒ Plástico
- ☞ Cromo ☒ Plastica



**Beam**

A++-A

incl. 1x13,5 / 1x2 W  
 1.476 + 247 lm, 2.700 K  
 230V, incl.  $\text{⏏}$  20 VA  
 ⌀300 ⇄300 ↗40 mm  
 EAN 4000870 706916  
**706.91**

LED

IP44



Bajonett

- ☞ Chrome ☒ Plastic
- ☞ Cromo ☒ Plástico
- ☞ Cromo ☒ Plastica



**Aviar**

A++-A

incl. 1x24 W  
 2.400 lm, 2.700 K  
 230V  
 ø300 ↗62 mm  
 EAN 4000870 708828  
**708.82 new**

LED

IP44



- ☞ Chrome ☒ Plastic
- ☞ Cromo ☒ Plástico
- ☞ Cromo ☒ Plastica



**Doradus**

A++-A

incl. 3×5 W  
3×430 lm, 3.000 K  
230 V  
ø250 ↗42 mm  
EAN 4000870 708743



**708.74 new**

- ☞ Chrome ☒ Metal/Plastic
- ☞ Cromo ☒ Metal/Plástico
- ☞ Cromo ☒ Metallo/Plastica



**Doradus**

A++-A

incl. 4×5 W  
4×430 lm, 3.000 K  
230 V  
↕250 ↔250 ↗47 mm  
EAN 4000870 708750



**708.75 new**

- ☞ Chrome ☒ Metal/Plastic
- ☞ Cromo ☒ Metal/Plástico
- ☞ Cromo ☒ Metallo/Plastica



**Minor**

A++-A

incl. 1×18 W  
1.000 lm, 3.000 K  
230 V, incl. ⚡25 VA  
ø230 ↗42 mm  
EAN 4000870 705094



**705.09**

- ☞ Satin ☒ Acrylic
- ☞ Satinado ☒ Acrílico
- ☞ Satinato ☒ Acrilico



**Minor**

A++-A

incl. 1x18 W  
1.000 lm, 3.000 K  
230 V, incl. ⚡ 25 VA  
⌀230 ⇨230 ⇨42 mm  
EAN 4000870 705087

LED

IP44



**705.08**

- ☞ Satin ☒ Acrylic
- ☞ Satinado ☒ Acrílico
- ☞ Satinato ☒ Acrilico



**Pollux**

A++-A

incl. 1x14 W  
750 lm, 3.000 K  
230 V, incl. ⚡ 19 VA  
ø320 ⇨60 mm  
EAN 4000870 704677

LED

IP44



**704.67**

- ☞ Chrome/White/Clear ☒ Metal/Acrylic
- ☞ Cromo/Blanco/Transparente ☒ Metal/Acrílico
- ☞ Cromo/Bianco/Trasparente ☒ Metallo/Acrilico



**Polar**

A++-A

incl. 1x11 W  
670 lm, 3.000 K  
230 V, incl. ⚡ 19 VA  
ø250 ⇨100 mm  
EAN 4000870 704653

LED



IP44



**704.65**

**Polar**

A++-A

incl. 1x14 W  
860 lm, 3.000 K  
230 V, incl. ⚡ 19 VA  
ø300 ⇨100 mm  
EAN 4000870 704660

LED



IP44



**704.66**

- ☞ Chrome/Opal ☒ Metal/Glass
- ☞ Cromo/Opal ☒ Metal/Cristal
- ☞ Cromo/Opale ☒ Metallo/Vetro



White Plastic  
Blanco Plástico  
Bianco Plastica



**Leonis**  
incl. 1x9,5 W  
670 lm, 2.700 K  
230V, incl. 14,5 VA  
ø270 ø96 mm  
EAN 4000870 707227  
**707.22**



**Leonis**  
incl. 1x11 W  
860 lm, 2.700 K  
230V, incl. 14,5 VA  
ø320 ø106 mm  
EAN 4000870 707234  
**707.23**



White Plastic  
Blanco Plástico  
Bianco Plastica



**Leonis**  
incl. 1x9,5 W  
670 lm, 4.000 K  
230V, incl. 14,5 VA  
ø270 ø96 mm  
EAN 4000870 707241  
**707.24**



**Leonis**  
incl. 1x11 W  
860 lm, 4.000 K  
230V, incl. 14,5 VA  
ø320 ø106 mm  
EAN 4000870 707258  
**707.25**







400.28  
892.39



**Arctus** A++-E  
 max. 60 W, E27 IP44  
 230 V  
 ø275 ↗80 mm   
 EAN 4000870 703441  
**703.44**  
 Brushed iron/Opaque Metal/  
 Glass  
 Hierro mateado/Opaco  
 Metal/Cristal  
 Ferro spazzolato/Opaco  
 Metallo/Vetro



**Arctus** A++-E  
 max. 60 W, E27 IP44  
 230 V  
 ø275 ↗80 mm   
 EAN 4000870 703458  
**703.45**  
 Chrome/Opaque Metal/Glass  
 Cromo/Opaco Metal/Cristal  
 Cromo/Opaco Metallo/Vetro



**Arctus** A++-E  
 max. 60 W, E27 IP44  
 230 V  
 ø275 ↗80 mm   
 EAN 4000870 703434  
**703.43**  
 White/Opaque Metal/Glass  
 Blanco/Opaco Metal/Cristal  
 Bianco/Opaco Metallo/Vetro



400.28  
880.15  
882.11  
892.39



**Vega** A++-E  
 max. 60 W, E27 IP44  
 230 V  
 ø320 ↗110 mm   
 EAN 4000870 703465  
**703.46**  
 Brushed iron/Opal Metal/  
 Glass  
 Hierro mateado/Opal Metal/  
 Cristal  
 Ferro spazzolato/Opale  
 Metallo/Vetro



**Vega** A++-E  
 max. 60 W, E27 IP44  
 230 V  
 ø320 ↗110 mm   
 EAN 4000870 703472  
**703.47**  
 White/Opal Metal/Glass  
 Blanco/Opal Metal/Cristal  
 Bianco/Opale Metallo/Vetro

**Mirfak**

max. 60 W, E27  
230 V  
ø320 ↗110 mm  
EAN 4000870 703489  
**703.48**

A++-E



Bajonett



- ☞ White/Mirror/Opal ☒ Metal/Glass
- ☞ Blanco/Espejo/Opal ☒ Metal/Cristal
- ☞ Bianco/Specchio/Opale ☒ Metallo/Vetro

💡 400.28  
880.15  
882.11  
892.39

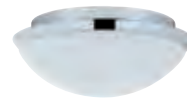
**Biabo**

max. 18 W, E27  
230 V  
ø250 ↗105 mm  
EAN 4000870 708040  
**708.04 new**

A++-E



- ☞ Chrome/White ☒ Metal/Acrylic
- ☞ Cromo/Blanco ☒ Metal/Acrílico
- ☞ Cromo/Bianco ☒ Metallo/Acricilo

💡 283.31  
283.77

**Ixa**

max. 18 W, E27  
230 V  
ø310 ↗110 mm  
EAN 4000870 708057  
**708.05 new**

A++-E



- ☞ Brushed iron/White ☒ Metal/Acrylic
- ☞ Hierro mateado/Blanco ☒ Metal/Acrílico
- ☞ Ferro spazzolato/Bianco ☒ Metallo/Acricilo

💡 283.31  
283.77



**Falima**

max. 18 W, E27  
230 V  
ø260 ↗105 mm  
EAN 4000870 708064  
**708.06 new**



☞ Chrome/White ☒ Metal/Acrylic  
☞ Cromo/Blanco ☒ Metal/Acrílico  
☞ Cromo/Bianco ☒ Metallo/Acricilo

💡 283.31  
283.77



**Deneb**

max. 2×40 W, E14  
230 V  
ø250 ↗115 mm  
EAN 4000870 703427  
**703.42**



☞ White/Opal ☒ Metal/Glass  
☞ Blanco/Opal ☒ Metal/Cristal  
☞ Bianco/Opale ☒ Metallo/Vetro

💡 510.44  
894.39



**Berengo**

max. 2×60 W, E27  
230 V  
ø300 ↗105 mm  
EAN 4000870 703410  
**703.41**



☞ White/Alabaster ☒ Metal/Glass  
☞ Blanco/Alabastro ☒ Metal/Cristal  
☞ Bianco/Alabastro ☒ Metallo/Vetro

💡 400.28  
892.39



**Doradus**

A++-A

incl. 3x5 W  
 3x430 lm, 3.000 K  
 230 V  
 ⌀95 ⇄350 ⚙42 mm  
 EAN 4000870 708767

**708.76 new**



- 🔗 Chrome 📦 Metal/Plastic
- 🔗 Cromo 📦 Metal/Plástico
- 🔗 Cromo 📦 Metallo/Plastica



**Doradus**

A++-A

incl. 2x5 W  
 2x430 lm, 3.000 K  
 230 V  
 ⌀95 ⇄230 ⚙42 mm  
 EAN 4000870 708835

**708.83 new**



- 🔗 Chrome 📦 Metal/Plastic
- 🔗 Cromo 📦 Metal/Plástico
- 🔗 Cromo 📦 Metallo/Plastica



⌘ Aluminium/Clear ⌘ Metal/Acrylic  
 ⌘ Aluminio/Transparente ⌘ Metal/Acrílico  
 ⌘ Alluminio/Trasparente ⌘ Metallo/Acricico



**Theta**

incl. 1x9W  
 440 lm, 3.000 K  
 230V, incl. ⚡ 10 VA  
 ⌀250 ⇄100 ⌀50 mm  
 EAN 4000870 704264  
**704.26**



**Theta**

incl. 1x13,5W  
 660 lm, 3.000 K  
 230V, incl. ⚡ 15 VA  
 ⌀100 ⇄400 ⌀50 mm  
 EAN 4000870 704271  
**704.27**







Aluminium/Clear Metal/Acrylic  
 Aluminio/Transparente Metal/Acrílico  
 Alluminio/Trasparente Metallo/Acricico



**Theta** A++-A  
 incl. 1x9W  
 440 lm, 3.000 K  
 230V, incl. -10 VA  
 ⌀250 ⇄100 ⚓50 mm  
 EAN 4000870 704783  
**704.78**



**Theta** A++-A  
 incl. 1x13,5W  
 660 lm, 3.000 K  
 230V, incl. -15 VA  
 ⌀100 ⇄400 ⚓50 mm  
 EAN 4000870 704790  
**704.79**



Aluminium/Clear Metal/Acrylic  
 Aluminio/Transparente Metal/Acrílico  
 Alluminio/Trasparente Metallo/Acricico



**Tucana** A++-A  
 incl. 1x4,5W  
 220 lm, 3.000 K  
 230V, incl. -8,4 VA  
 ⌀225 ⇄100 ⚓120 mm  
 EAN 4000870 704752  
**704.75**



**Tucana** A++-A  
 incl. 1x9W  
 440 lm, 3.000 K  
 230V, incl. -10 VA  
 ⌀250 ⇄100 ⚓50 mm  
 EAN 4000870 704769  
**704.76**



**Tucana** A++-A  
 incl. 1x13,5W  
 660 lm, 3.000 K  
 230V, incl. -15 VA  
 ⌀100 ⇄400 ⚓50 mm  
 EAN 4000870 704776  
**704.77**



Aluminium/Clear Metal/Acrylic  
 Aluminio/Transparente Metal/Acrílico  
 Alluminio/Trasparente Metallo/Acricico



**Tucana** A++-A  
 incl. 1x4,5W  
 220 lm, 3.000 K  
 230V, incl. -8,4 VA  
 ⌀225 ⇄100 ⚓120 mm  
 EAN 4000870 704721  
**704.72**



**Tucana** A++-A  
 incl. 1x9W  
 440 lm, 3.000 K  
 230V, incl. -10 VA  
 ⌀250 ⇄100 ⚓50 mm  
 EAN 4000870 704738  
**704.73**



**Tucana** A++-A  
 incl. 1x13,5W  
 660 lm, 3.000 K  
 230V, incl. -15 VA  
 ⌀100 ⇄400 ⚓50 mm  
 EAN 4000870 704745  
**704.74**

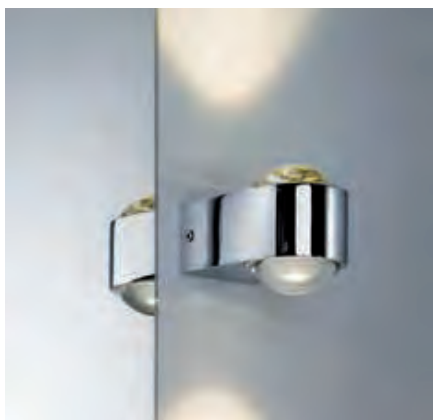

- ☞ Chrome ☒ Metal/Glass
- ☞ Cromo ☒ Metal/Cristal
- ☞ Cromo ☒ Metallo/Vetro



### Capella

incl. 2x3,5 W  
 2x250 lm, 2.700 K  
 < 45°  
 230 V, incl. ⚡ 8 VA  
 ⌀83 ⇄64 ↻100 mm  
 EAN 4000870 704950  
**704.95**

A++-A

LED

☉ IP44



- ☞ Chrome/Satin ☒ Metal/Glass
- ☞ Cromo/Satinado ☒ Metal/Cristal
- ☞ Cromo/Satinato ☒ Metallo/Vetro

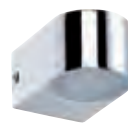

### Bellatrix

incl. 2x3,5 W  
 2x220 lm, 2.700 K  
 < 90°  
 230 V, incl. ⚡ 8 VA  
 ⌀48 ⇄64 ↻100 mm  
 EAN 4000870 704943  
**704.94**

A++-A

LED

☉ IP44



**Diadem**

A++-A

incl. 2x3,5 W  
2x250 lm, 2.700 K  
230 V, incl.  $\approx$  8,4 VA  
 $\varnothing$ 160  $\leftrightarrow$ 80  $\varnothing$ 128 mm  
EAN 4000870 704929



**704.92**

- ☞ Chrome/White ☐ Metal/Acrylic
- ☞ Cromo/Blanco ☐ Metal/Acrílico
- ☞ Cromo/Bianco ☐ Metallo/Acricilo

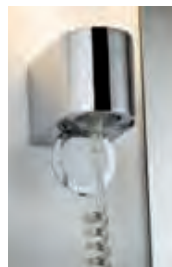

**Elektra**

A++-A

incl. 1x4,5 W  
400 lm, 3.000 K  
230 V, incl.  $\approx$  8,4 VA  
 $\varnothing$ 242  $\leftrightarrow$ 64  $\varnothing$ 100 mm  
EAN 4000870 706077



**706.07**

- ☞ Chrome/Opal ☐ Metal/Glass
- ☞ Cromo/Opal ☐ Metal/Cristal
- ☞ Cromo/Opale ☐ Metallo/Vetro

💡 282.61



**Asterion**

A++-A

incl. 1x4,5 W  
400 lm, 3.000 K  
230 V, incl.  $\approx$  8,4 VA  
 $\varnothing$ 264  $\leftrightarrow$ 300  $\varnothing$ 150 mm  
EAN 4000870 706084



**706.08**

- ☞ Chrome/Opal ☐ Metal/Glass
- ☞ Cromo/Opal ☐ Metal/Cristal
- ☞ Cromo/Opale ☐ Metallo/Vetro

💡 282.61



**Carina** A++-E  
 max. 28 W, G9  
 230 V  
 ⌀157 ⌀105 ⇔105 ↗115 mm  
 EAN 4000870 708385  
**708.38 new**



☞ Chrome matt/Satin ☒ Metal/Glass  
 ☞ Cromo mate/Satinado ☒ Metal/Cristal  
 ☞ Cromo opaco/Satinato ☒ Metallo/Vetro

💡 283.38  
 283.42  
 283.43



**Eleon** A++-E  
 max. 33 W, G9  
 230 V  
 ⌀203 ⌀105 ⇔105 ↗135 mm  
 EAN 4000870 708392  
**708.39 new**



☞ Chrome/Satin ☒ Metal/Glass  
 ☞ Cromo/Satinado ☒ Metal/Cristal  
 ☞ Cromo/Satinato ☒ Metallo/Vetro

💡 283.38  
 283.42  
 283.43



**Antares** D-E  
 incl. 1×33 W, G9, D  
 460 lm, 2.800 K  
 230 V  
 ⌀165 ⇔90 ↗110 mm  
 EAN 4000870 703595  
**703.59**



☞ Chrome/Opal ☒ Metal/Glass  
 ☞ Cromo/Opal ☒ Metal/Cristal  
 ☞ Cromo/Opale ☒ Metallo/Vetro

💡 800.31



Chrome/Satin Metal/Glass  
 Cromo/Satinado Metal/Cristal  
 Cromo/Satinato Metallo/Vetro

510.43  
 894.39



**Gemini Set**

max. 2x40W, E14  
 230V  
 195 85 105 mm  
 EAN 4000870 703540  
**703.54**

A++-E  
 IP44



Chrome/Satin Metal/Glass  
 Cromo/Satinado Metal/Cristal  
 Cromo/Satinato Metallo/Vetro

510.43  
 894.39



**Gemini**

max. 2x40W, E14  
 230V  
 85 310 105 mm  
 EAN 4000870 703519  
**703.51**

A++-E  
 IP44



Chrome/Opaque Metal/Glass  
 Cromo/Opaco Metal/Cristal  
 Cromo/Opaco Metallo/Vetro

510.43  
 894.39



**Lenia**

max. 2x40W, E14  
 230V  
 80 330 105 mm  
 EAN 4000870 703502  
**703.50**

A++-E  
 IP44





**Saphir**

max. 2×40 W, E14  
 230 V  
 ⌀80 ⇄445 ⌀120 mm  
 EAN 4000870 703588  
**703.58**

A++-E  
 IP44

- ☞ Chrome/Opal ☞ Metal/Glass
- ☞ Cromo/Opal ☞ Metal/Cristal
- ☞ Cromo/Opale ☞ Metallo/Vetro

💡 510.43  
 860.07



**Lukida**

incl. 1×9 W  
 650 lm, 3.000 K  
 230 V, incl. ⚡10 VA  
 ⌀100 ⇄600 ⌀42 mm  
 EAN 4000870 704639  
**704.63**

A++-A  
 LED  
 IP44

- ☞ Chrome/White ☞ Aluminium/Acrylic
- ☞ Cromo/Blanco ☞ Aluminio/Acrílico
- ☞ Cromo/Bianco ☞ Alluminio/Acrilico



**Nimbus**

incl. 1×9 W  
 600 lm, 3.000 K  
 230 V, incl. ⚡10 VA  
 ⌀68 ⇄600 ⌀63 mm  
 EAN 4000870 704646  
**704.64**

A++-A  
 LED  
 IP44

- ☞ Chrome/White ☞ Metal/Acrylic
- ☞ Cromo/Blanco ☞ Metal/Acrílico
- ☞ Cromo/Bianco ☞ Metallo/Acrilico



**Kuma** A++-A

incl. 1x9 W  
 660 lm, 3.000 K  
 230 V, incl.  $\text{⚡}$  10 VA  
 $\text{⌀}$  45  $\text{↔}$  500  $\text{↻}$  84 mm  
 EAN 4000870 704707  
**704.70**

LED  
 $\text{⌀}$  IP44  
 $\text{⊞}$

⌘ Chrome/White ⊞ Metal/Acrylic  
⌘ Cromo/Blanco ⊞ Metal/Acrílico  
⌘ Cromo/Bianco ⊞ Metallo/Acricilo



**Proxima** A++-A

incl. 2x3,5 W  
 2x250 lm, 2.700 K  
 230 V, incl.  $\text{⚡}$  10 VA  
 $\text{⌀}$  70  $\text{↔}$  300  $\text{↻}$  95 mm  
 EAN 4000870 704691  
**704.69**

LED  
 $\text{⌀}$  IP44  
 $\text{⊞}$

**Proxima** A++-A

incl. 3x3,5 W  
 3x250 lm, 2.700 K  
 230 V, incl.  $\text{⚡}$  10 VA  
 $\text{⌀}$  70  $\text{↔}$  500  $\text{↻}$  95 mm  
 EAN 4000870 704714  
**704.71**

LED  
 $\text{⌀}$  IP44  
 $\text{⊞}$

⌘ Chrome/White ⊞ Metal/Plastic  
⌘ Cromo/Blanco ⊞ Metal/Plástico  
⌘ Cromo/Bianco ⊞ Metallo/Plastica



- 🔗 White 📦 Aluminium/Acrylic
- 🔗 Blanco 📦 Aluminio/Acrílico
- 🔗 Bianco 📦 Alluminio/Acricico



**Arneb** A++-A

incl. 1x9 W  
 760 lm, 3.000 K  
 230 V  
 ⌀40 ⇔320 ↗78 mm  
 EAN 4000870 708781  
**708.78 new**

LED

IP44



- 🔗 Chrome 📦 Aluminium/Acrylic
- 🔗 Cromo 📦 Aluminio/Acrílico
- 🔗 Cromo 📦 Alluminio/Acricico



**Arneb** A++-A

incl. 1x9 W  
 760 lm, 3.000 K  
 230 V  
 ⌀40 ⇔320 ↗78 mm  
 EAN 4000870 708798  
**708.79 new**

LED

IP44



- 🔗 Chrome/White 📦 Metal/Acrylic
- 🔗 Cromo/Blanco 📦 Metal/Acrílico
- 🔗 Cromo/Bianco 📦 Metallo/Acricico



**Mizar** A-A

incl. 1x8 W, G5 / T5, A

480 lm, 3.000 K  
 230 V  
 ⌀45 ⇔370 ↗80 mm  
 EAN 4000870 703601  
**703.60**

💡 885.08

Energy Saver

IP44

50.000h



**Mizar** A-A

incl. 1x14 W, G5 / T5, A

1.204 lm, 3.000 K  
 230 V  
 ⌀45 ⇔630 ↗80 mm  
 EAN 4000870 703618  
**703.61**

💡 884.49

Energy Saver

IP44

50.000h



Chrome/White Metal/Acrylic  
Cromo/Blanco Metal/Acrílico  
Cromo/Bianco Metallo/Acricilo



**Orgon**

incl. 1x8 W, G5 / T5, **A**  
480 lm, 3.000 K  
230 V  
∅60 ⇄440 ↗80 mm  
EAN 4000870 703625  
**703.62**

885.08



**Orgon**

incl. 1x14 W, G5 / T5, **A**  
1.204 lm, 3.000 K  
230 V  
∅60 ⇄700 ↗80 mm  
EAN 4000870 703632  
**703.63**

884.49



Chrome/White Metal/Acrylic  
Cromo/Blanco Metal/Acrílico  
Cromo/Bianco Metallo/Acricilo

884.49



**Taru**

incl. 1x14 W, G5 / T5, **A\***  
1.204 lm, 3.000 K  
230 V  
∅65 ⇄575 ↗100 mm  
EAN 4000870 703663  
**703.66**



Chrome/White Metal/Acrylic  
Cromo/Blanco Metal/Acrílico  
Cromo/Bianco Metallo/Acricilo



**Quasar**

incl. 1x8 W, G5 / T5, **A**  
480 lm, 3.000 K  
230 V  
∅45 ⇄440 ↗60 mm  
EAN 4000870 703649  
**703.64**

885.08



**Quasar**

incl. 1x14 W, G5 / T5, **A\***  
1.204 lm, 3.000 K  
230 V  
∅45 ⇄700 ↗60 mm  
EAN 4000870 703656  
**703.65**

884.49





- ☞ Chrome ☒ Metal
- ☞ Cromo ☒ Metal
- ☞ Cromo ☒ Metallo

💡 282.86



**Mintaka**

A++-E

max. 20W, GU10  
230V  
⌀38 ⇄56 ↻120 mm  
EAN 4000870 708804  
**708.80 new**



- ☞ Chrome ☒ Metal/Plastic
- ☞ Cromo ☒ Metal/Plástico
- ☞ Cromo ☒ Metallo/Plastica



**Becrux**

A++-A

incl. 1x4W  
350 lm, 3.000 K  
230V  
⌀93 ⇄93 ↻140 mm  
EAN 4000870 708811  
**708.81 new**

LED



- ☞ Chrome/White ☒ Metal/Acrylic
- ☞ Cromo/Blanco ☒ Metal/Acrílico
- ☞ Cromo/Bianco ☒ Metallo/Acricolo



**Zeta**

A++-A

incl. 1x5,5W  
410 lm, 3.000 K  
230V, incl. ⚡8,4 VA  
⌀34 ⇄600 ↻14 mm  
EAN 4000870 706107  
**706.10**

LED

IP44







**Navi**

incl. 3x2,4 W  
3x130 lm, 3.000 K  
230 V, incl.  $\approx$  8,4 VA  
 $\varnothing$ 60  $\varnothing$ 30  $\varnothing$ 58 mm  
EAN 4000870 706114  
**706.11**

- A++-A
- LED
- IP44
- 
- 



- Chrome/White Aluminium/Acrylic
- Cromo/Blanco Aluminio/Acrílico
- Cromo/Bianco Alluminio/Acrilico



**Bela**

incl. 1x5,7 W  
260 lm, 3.000 K  
230 V, incl.  $\approx$  8,4 VA  
 $\varnothing$ 230  $\leftrightarrow$ 230  $\varnothing$ 295 mm  
EAN 4000870 704684  
**704.68**

- A++-A
- LED
- IP44
- 
- 
- On/Off

- Chrome/White/Mirror Metal/Acrylic
- Cromo/Blanco/Espejo Metal/Acrílico
- Cromo/Bianco/Specchio Metallo/Acrilico



**Bela**

max. 40 W, E14  
230 V  
 $\varnothing$ 235  $\leftrightarrow$ 470  $\varnothing$ 350 mm  
EAN 4000870 703496  
**703.49**

- A++-E
- 
- 
- On/Off

- Chrome/Mirror Metal/Glass
- Cromo/Espejo Metal/Cristal
- Cromo/Specchio Metallo/Vetro

510.43  
860.07



☞ Chrome/Satin ☒ Metal/Glass  
 ☞ Cromo/Satinado ☒ Metal/Cristal  
 ☞ Cromo/Satinato ☒ Metallo/Vetro

💡 282.99



**Lyra**

A++-E

incl. 3×3,5 W, GU10, A++  
 3×230 lm, 3.000 K  
 230 V  
 ⌀110 ø250 mm  
 EAN 4000870 706091  
**706.09**



☞ Chrome/Transparent ☒ Metal/Glass  
 ☞ Cromo/Transparente ☒ Metal/Cristal  
 ☞ Cromo/Trasparente ☒ Metallo/Vetro

💡 283.38

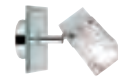

**Trabani**

A++-E

max. 20 W, G9  
 230 V  
 ⌀110 ⇔110 ↗135 mm  
 EAN 4000870 708408  
**708.40 new**



**Trabani**

A++-E

max. 2×20 W, G9  
 230 V  
 ⌀80 ⇔280 ↗125 mm  
 EAN 4000870 708415  
**708.41 new**



**Trabani**

A++-E

max. 3×20 W, G9  
 230 V  
 ø240 ↗135 mm  
 EAN 4000870 708422  
**708.42 new**



☞ White/Chrome ☒ Metal  
 ☞ Blanco/Cromo ☒ Metal  
 ☞ Bianco/Cromo ☒ Metallo

💡 282.99  
 283.00



**Drop IP44**

A++-E

max. 10 W, GU10  
 230 V  
 ⌀123 ø100 ↗165 mm  
 EAN 4000870 667149  
**667.14 new**



**Drop IP44**

A++-E

max. 2×10 W, GU10  
 230 V  
 ⌀165 ⇔350 ↗65 mm  
 EAN 4000870 667156  
**667.15 new**



**Drop IP44**

A++-E

max. 3×10 W, GU10  
 230 V  
 ⌀165 ø250 mm  
 EAN 4000870 667163  
**667.16 new**





White/Chrome Metal  
Blanco/Cromo Metal  
Bianco/Cromo Metallo

282.99  
283.00



**Zyli IP44** A++-E  
max. 10 W, GU10  
230 V  
Ø100 ↗110 mm  
EAN 4000870 667101  
**667.10 new**



**Zyli IP44** A++-E  
max. 2×10 W, GU10  
230 V  
↕110 ↔400 ↗70 mm  
EAN 4000870 667118  
**667.11 new**



**Zyli IP44** A++-E  
max. 3×10 W, GU10  
230 V  
↕110 ↔600 ↗70 mm  
EAN 4000870 667132  
**667.13 new**



**Zyli IP44** A++-E  
max. 3×10 W, GU10  
230 V  
↕110 Ø250 mm  
EAN 4000870 667125  
**667.12 new**



White/Chrome Metal  
Blanco/Cromo Metal  
Bianco/Cromo Metallo

282.99  
283.00



**Tube IP44** A++-E  
max. 10 W, GU10  
230 V  
↕138 Ø100 ↗94 mm  
EAN 4000870 667170  
**667.17 new**



**Tube IP44** A++-E  
max. 2×10 W, GU10  
230 V  
↕94 ↔350 ↗65 mm  
EAN 4000870 667187  
**667.18 new**



**Tube IP44** A++-E  
max. 3×10 W, GU10  
230 V  
↕94 Ø250 mm  
EAN 4000870 667194  
**667.19 new**



# Neordic

## Neordic living area luminaires – new, Nordic, natural

The new Neordic series pendant, floor and table luminaires match the latest trend in Scandinavian-inspired design. Simple elegance, natural materials and pleasant colour combinations create a homely atmosphere and add warm, Nordic accents to your home. Real wood with warm light shining through meets copper and concrete, creating a harmonious alliance with gold and soft green. The modern Neordic styles are highly versatile – black or white marble with gold and glass, matt black metal and bright fabric, or simple concrete with elegant metal frames. And the Neordic luminaires can be ideally completed with a large selection of decorative Paulmann LED lamps.

## Lámparas para el hogar Neordic: nuevas, nórdicas, naturales

Las lámparas colgantes, de pie y de sobremesa de la nueva serie Neordic siguen la tendencia actual del diseño de inspiración escandinava. Elegancia sencilla, materiales naturales y combinaciones de colores agradables enriquecen el ambiente del hogar, aportando acentos nórdicos y, a la vez, cálidos. La madera auténtica, iluminada cálidamente, se combina con el cobre y el hormigón, pero también crea una alianza armoniosa con los colores oro y verde satinado. Mármol negro o blanco con oro y cristal, metal negro mate y materiales textiles claros o sencillo hormigón con un elegante casquillo de metal: los modernos mundos de estilo Neordic son de lo más variado. Además, las luminarias Neordic se pueden equipar perfectamente con la amplia selección de decorativas lámparas LED de Paulmann.

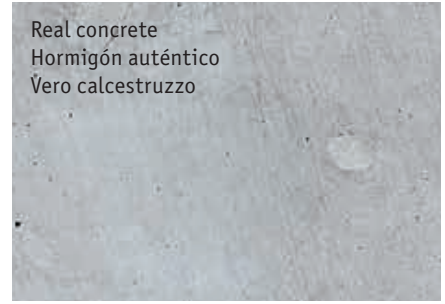

Real concrete  
Hormigón auténtico  
Vero calcestruzzo

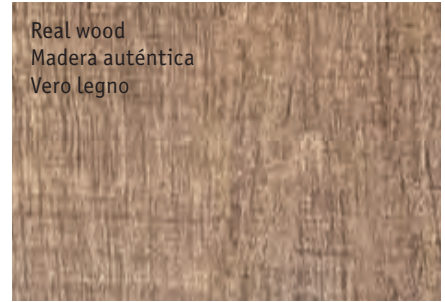

Real wood  
Madera auténtica  
Vero legno

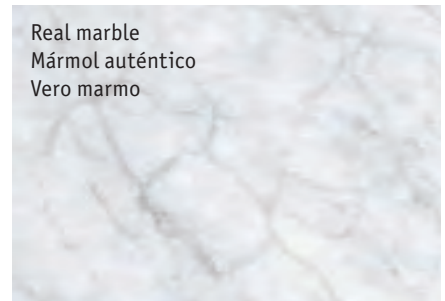

Real marble  
Mármol auténtico  
Vero marmo



Fabric cable  
Cable textil  
Cavo tessile

## Neordic Luci per locali abitativi - nuove, nordiche, naturali

Le lampade a sospensione, da terra e da tavolo della nuova serie Neordic seguono pienamente la tendenza del design di ispirazione scandinava. Eleganza sobria, materiali naturali e piacevoli combinazioni di colori arricchiscono l'ambiente della vostra casa, dando un tocco „nordico“ e allo stesso tempo caldo. Vero legno, caldamente illuminato, abbinato a rame e calcestruzzo crea anche con l'oro e il verde tenue un'unione armoniosa. Marmo nero e bianco con oro e vetro, metallo nero opaco e tessuto chiaro o calcestruzzo sobrio con raffinato portalampada in metallo - i moderni stili Neordic sono estremamente versatili. Inoltre l'ampia gamma di lampadine LED decorative Paulmann è il complemento perfetto delle lampade Neordic.





796.30 ☐ = 51



796.32 ☐ = 52



796.31 ☐ = 52



796.34 ☐ = 52



796.40 ☐ = 53



796.46 ☐ = 53



796.33 ☐ = 53



796.85 ☐ = 54



796.47 ☐ = 55



796.53 ☐ = 56



796.29 ☐ = 59



503.28 ☐ = 59



796.60 ☐ = 60



796.89 ☐ = 61



503.23 ☐ = 62



503.22 ☐ = 62



796.27 ☐ = 79



796.44 ☐ = 64



796.42 ☐ = 64



796.83 ☐ = 65



796.88 ☐ = 67



796.05 ☐ = 68



796.09 ☐ = 67



796.08 ☐ = 67



796.12 ☐ = 67



796.62 ☐ = 67



796.15 ☐ = 69



796.06 ☐ = 72



796.07 ☐ = 72



796.11 ☐ = 73



796.16 ☐ = 75



796.18 ☐ = 75



503.32 ☐ = 76



796.21 ☐ = 76



796.63 ☐ = 76



796.17 ☐ = 77



796.25 ☐ = 78



796.22 ☐ = 78



796.24 ☐ = 79



796.65 ☐ = 79





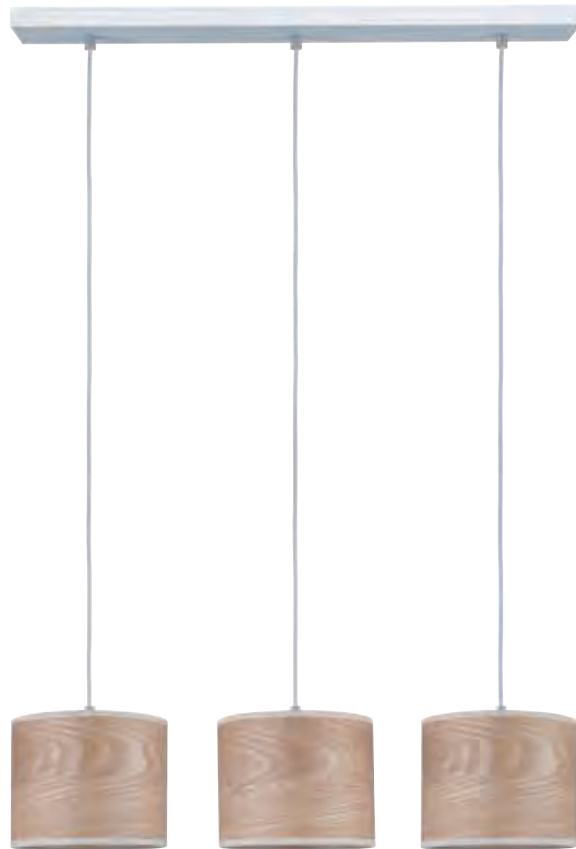

**2**  
 284.81  
 284.23  
 283.78  
 283.77  
 283.31  
 283.32  
 283.74  
 283.73

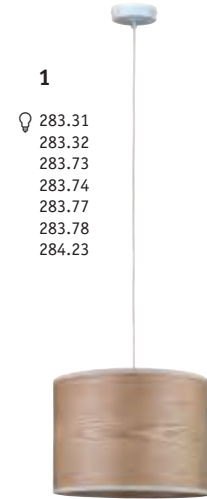

**1**  
 283.31  
 283.32  
 283.73  
 283.74  
 283.77  
 283.78  
 284.23

**1 Neta** A++-E  
 max. 20 W, E27  
 230 V  
 ⚡148 cm ø380 mm  
 EAN 4000870 796306  
**796.30 new**

**2 Neta** A++-E  
 max. 3x20 W, E27  
 230 V  
 ⚡139 cm ↔600 mm ↻100 mm  
 EAN 4000870 796412  
**796.41 new**

**3 Neta** A++-E  
 max. 20 W, E27  
 230 V  
 ⚡1.510 ø350 mm  
 EAN 4000870 796375  
**796.37 new**

**4 Neta** A++-E  
 max. 20 W, E27  
 230 V  
 ⚡445 ø220 mm  
 EAN 4000870 796382  
**796.38 new**

🌳 Wood/White 🏠 Wood/Metal  
 🌳 Madera/Blanco 🏠 Madera/  
 Metal  
 🌳 Legno/Bianco 🏠 Legno/Metallo

**5 Skadi** A++-E  
 max. 20 W, E14  
 230 V  
 ⚡350 ø110 mm  
 EAN 4000870 796641  
**796.64 new**

🌳 Wood/Grey 🏠 Wood/Concrete  
 🌳 Madera/Gris 🏠 Madera/  
 Hormigón  
 🌳 Legno/Grigio 🏠 Legno/Cemento



**3**  
 283.31  
 283.32  
 283.73  
 283.74  
 283.77  
 283.78

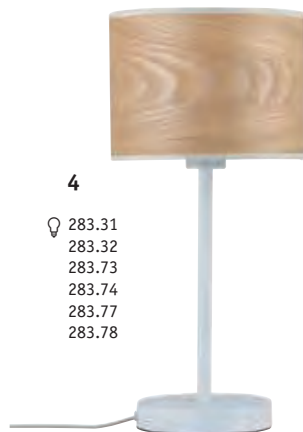

**4**  
 283.31  
 283.32  
 283.73  
 283.74  
 283.77  
 283.78

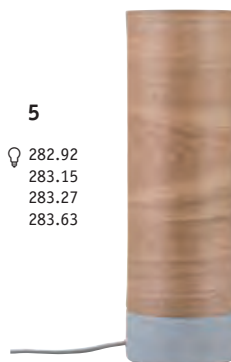

**5**  
 282.92  
 283.15  
 283.27  
 283.63



1

284.23  
283.78



3

283.31  
283.32  
283.77  
283.78



2

284.25  
284.23



4

283.78  
283.33  
283.85



**1 Ylvie** A++-E  
 max. 20 W, E27  
 230 V  
 ⚙ 144 cm ø135 mm  
 EAN 4000870 796320  
**796.32 new**

**2 Yva** A++-E  
 max. 20 W, E27  
 230 V  
 ⚙ 142 cm ø235 mm  
 EAN 4000870 796313  
**796.31 new**

🔗 Clear/Wood 🗪 Glass/Wood  
 🔗 Transparente/Madera 🗪 Cristal/Madera  
 🔗 Trasparente/Legno 🗪 Vetro/Legno

**3 Stellan** A++-E  
 max. 20 W, E27  
 230 V  
 ⚙ 1.615 ø350 mm  
 EAN 4000870 796344  
**796.34 new**

**4 Stellan** A++-E  
 max. 20 W, E27  
 230 V  
 ⚙ 400 ø155 mm  
 EAN 4000870 796368  
**796.36 new**

🔗 White/Wood 🗪 Fabric/Metal/Wood  
 🔗 Blanco/Madera 🗪 Tela/Metal/Madera  
 🔗 Bianco/Legno 🗪 Tessuto/Metallo/Legno



283.79  
283.87  
283.88  
283.93  
283.94  
284.57



1 **Talin**

A++-E

max. 20 W, E27  
230 V  
130 ø90 mm  
EAN 4000870 796405  
**796.40 new**



Wood Wood  
Madera Madera  
Legno Legno



283.85  
283.33

2 **Berit**

A++-E

max. 20 W, E27  
230 V  
315 ø220 mm  
EAN 4000870 796467  
**796.46 new**



White/Wood Fabric/Wood/  
Metal  
Blanco/Madera Tela/Madera/  
Metal  
Bianco/Legno Tessuto/  
Legno/Metallo



3

283.31  
283.32  
283.77  
283.78



4

283.31  
283.32  
283.77  
283.78

3 **Rurik**

A++-E

max. 20 W, E27  
230 V  
1.530 ø538 mm  
EAN 4000870 796337  
**796.33 new**



4 **Rurik**

A++-E

max. 20 W, E27  
230 V  
700 ø250 mm  
EAN 4000870 796351  
**796.35 new**



Grey/Wood Fabric/Metal/  
Wood  
Gris/Madera Tela/Metal/  
Madera  
Grigio/Legno Tessuto/  
Metallo/Legno



1

282.98  
283.31  
283.32  
283.49  
284.23



1 **Liska**

A++-E

max. 3×20 W, E27  
230 V  
150 ø450 mm  
EAN 4000870 796870  
**796.87 new**



Dark wood Wood/Metal  
Madera oscura Madera/Metal  
Legno scuro Legno/Metallo

2

282.98  
283.31  
283.32  
283.49  
284.23

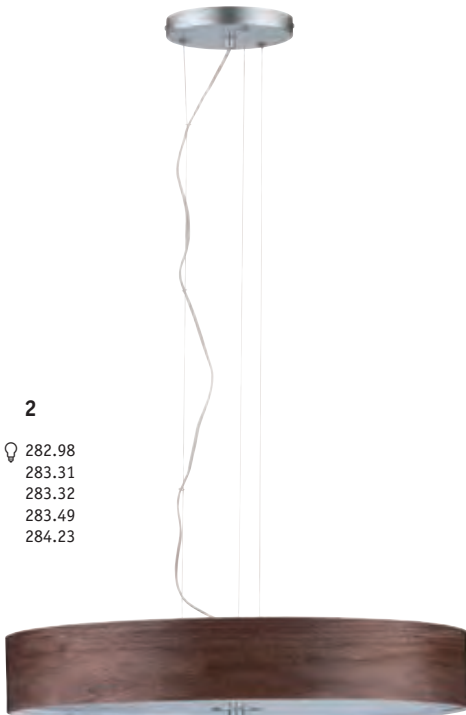

3

282.98  
283.31  
283.32  
283.78



2 **Liska**

A++-E

max. 3×20 W, E27  
230 V  
132 cm ø600 mm  
EAN 4000870 796863  
**796.86 new**



3 **Liska**

A++-E

max. 3×20 W, E27  
230 V  
1.420 ø450 mm  
EAN 4000870 796856  
**796.85 new**



incl.



On/Off

4 **Liska**

A++-E

max. 2×20 W, E27  
230 V  
400 ø320 mm  
EAN 4000870 796849  
**796.84 new**



incl.



On/Off

Dark wood/Chrome matt  
Wood/Metal  
Madera oscura/Cromo mate  
Madera/Metal  
Legno scuro/Cromo opaco  
Legno/Metallo

4

282.98  
283.31  
283.32  
283.78





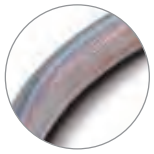

Transparent cable with copper core  
Cable transparente con hilo de cobre  
Cavo trasparente con trefolo di rame

1

282.98  
283.31  
283.32  
283.49  
284.23



1 **Liska**

A++-E

max. 3×20 W, E27  
230 V  
150 ø450 mm  
EAN 4000870 796504  
**796.50 new**

Wood Wood/Metal  
Madera Madera/Metal  
Legno Legno/Metallo



2

282.98  
283.31  
283.32  
283.49  
284.23

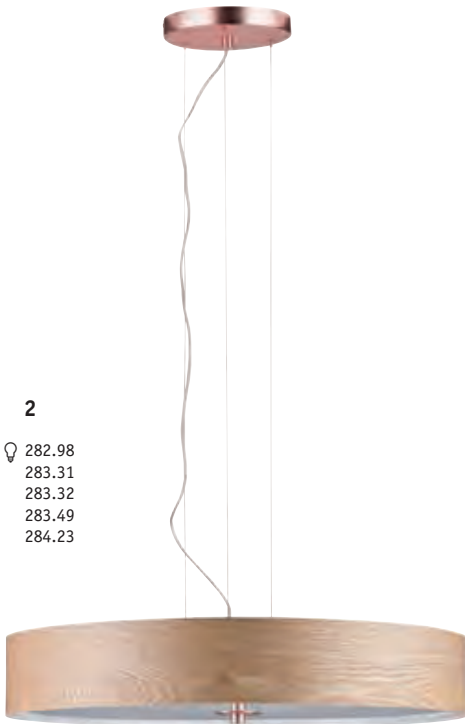

3

282.98  
283.31  
283.32  
283.78



2 **Liska**

A++-E

max. 3×20 W, E27  
230 V  
132,5 cm ø600 mm  
EAN 4000870 796498  
**796.49 new**

3 **Liska**

A++-E

max. 3×20 W, E27  
230 V  
1.420 ø450 mm  
EAN 4000870 796481  
**796.48 new**

4 **Liska**

A++-E

max. 2×20 W, E27  
230 V  
400 ø320 mm  
EAN 4000870 796474  
**796.47 new**

Wood/Matt copper Wood/  
Metal  
Madera/Cobre mate Madera/  
Metal  
Legno/Rame opaco Legno/  
Metallo

4

282.98  
283.31  
283.32  
283.78







**1**  
 283.70  
 284.41  
 284.55  
 285.01

**2**  
 283.70  
 284.41  
 284.55  
 285.01

**3**  
 283.77  
 283.78  
 283.79  
 284.23  
 284.56  
 284.57

**4**  
 283.70  
 284.41  
 284.55

**5**  
 283.70  
 284.41  
 284.55

**1 Juna** A++-E

max. 20 W, E14  
 230 V  
 172,5 cm ø160 mm  
 EAN 4000870 796528  
**796.52 new**



**2 Juna** A++-E

max. 3x20 W, E14  
 230 V  
 170 cm ø460 mm  
 EAN 4000870 796535  
**796.53 new**



**3 Juna** A++-E

max. 20 W, E27  
 230 V  
 145,5 cm ø342 mm  
 EAN 4000870 796559  
**796.55 new**



**4 Juna** A++-E

max. 20 W, E14  
 230 V  
 1.580 ø400 mm  
 EAN 4000870 796542  
**796.54 new**



**5 Juna** A++-E

max. 20 W, E14  
 230 V  
 510 ø255 mm  
 EAN 4000870 796511  
**796.51 new**



- 🌿 Soft green/Copper/Wood
- 🏠 Metal/Wood
- 🌿 Verde satinado/Cobre/Madera
- 🏠 Metal/Madera
- 🌿 Verde tenue/Rame/Legno
- 🏠 Metallo/Legno



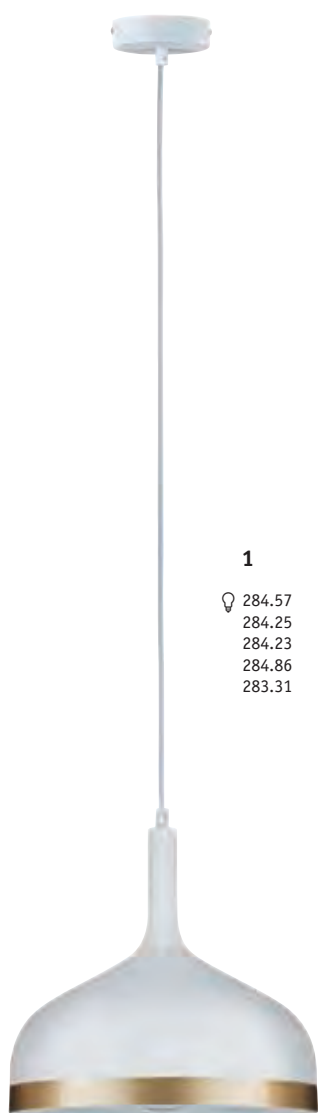

**1**

 284.57  
 284.25  
 284.23  
 284.86  
 283.31

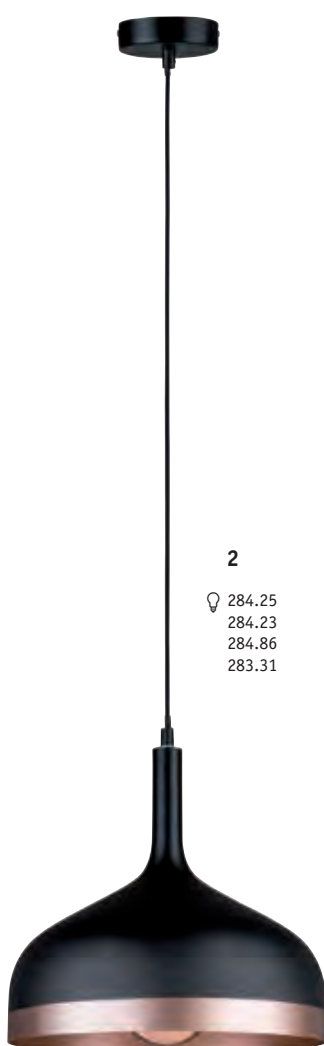
**2**

 284.25  
 284.23  
 284.86  
 283.31

**3**







 283.79  
 283.80  
 283.81  
 283.88  
 283.89  
 283.90  
 283.91  
 283.92  
 283.93  
 283.94  
 283.95

**1 Embla**

A++-E

max. 20 W, E27  
 230 V  
 ⚡ 150 cm ø300 mm  
 EAN 4000870 796283

**796.28 new**







-  Matt white/Gold  Metal
-  Blanco mate/Oro  Metal
-  Bianco opaco/Oro  Metallo

**2 Embla**

A++-E

max. 20 W, E27  
 230 V  
 ⚡ 150 cm ø300 mm  
 EAN 4000870 796290

**796.29 new**







-  Black/Matt copper  Metal
-  Negro/Cobre mate  Metal
-  Nero/Rame opaco  Metallo

**3 Pendulum**

A++-E

max. 60 W, E27  
 230 V  
 ⚡ 200 cm ø50 mm  
 EAN 4000870 503287

**503.28 new**

-  Copper  Metal/Plastic
-  Cobre  Metal/Plástico
-  Rame  Metallo/Plastica

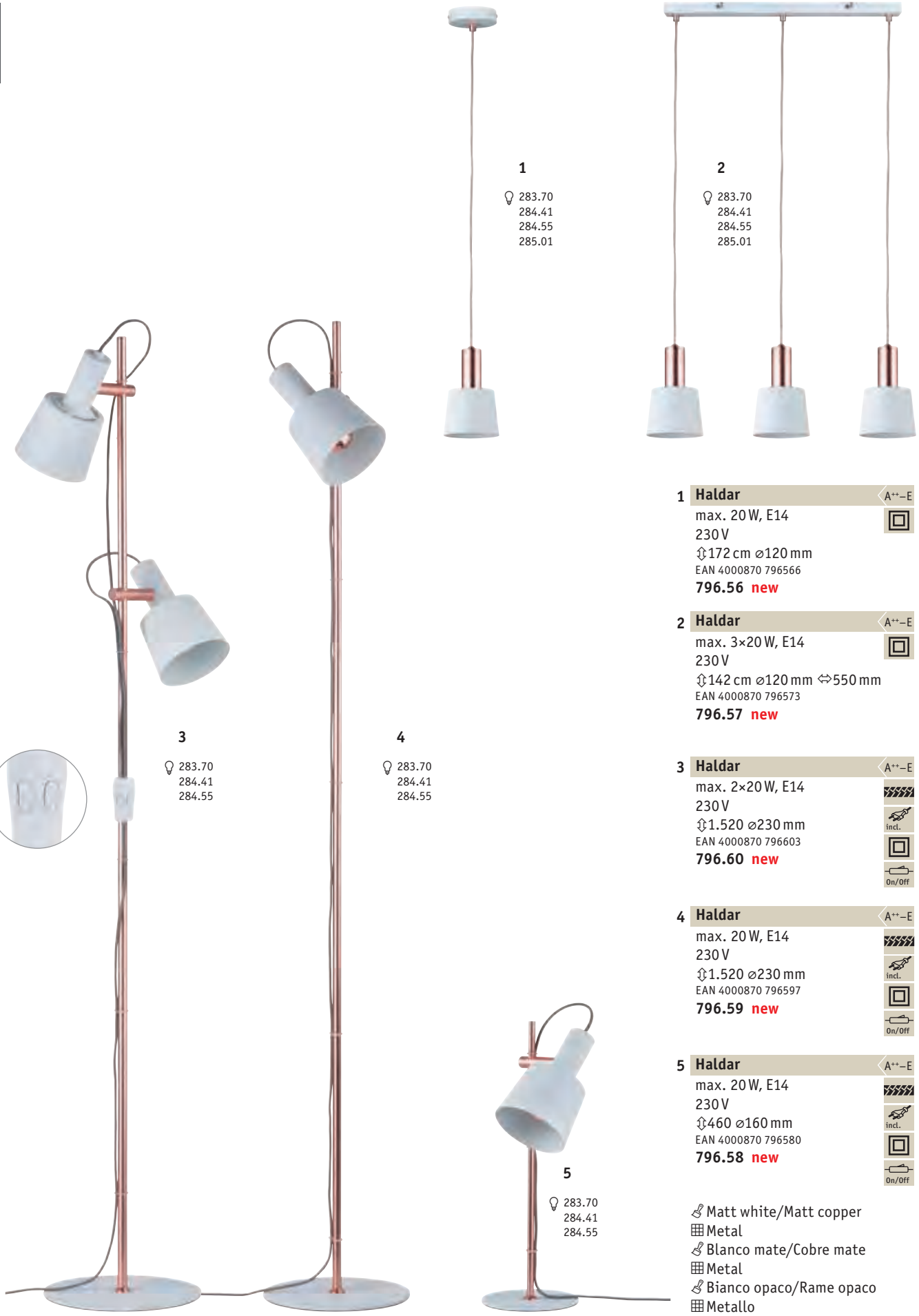

**1**  
 ⚡ 283.70  
 284.41  
 284.55  
 285.01

**2**  
 ⚡ 283.70  
 284.41  
 284.55  
 285.01

**3**  
 ⚡ 283.70  
 284.41  
 284.55

**4**  
 ⚡ 283.70  
 284.41  
 284.55

**5**  
 ⚡ 283.70  
 284.41  
 284.55

**1 Haldar** A++-E  
 max. 20 W, E14  
 230 V  
 ⚡ 172 cm ø120 mm  
 EAN 4000870 796566  
**796.56 new**

**2 Haldar** A++-E  
 max. 3x20 W, E14  
 230 V  
 ⚡ 142 cm ø120 mm ⇔550 mm  
 EAN 4000870 796573  
**796.57 new**

**3 Haldar** A++-E  
 max. 2x20 W, E14  
 230 V  
 ⚡ 1.520 ø230 mm  
 EAN 4000870 796603  
**796.60 new**

**4 Haldar** A++-E  
 max. 20 W, E14  
 230 V  
 ⚡ 1.520 ø230 mm  
 EAN 4000870 796597  
**796.59 new**

**5 Haldar** A++-E  
 max. 20 W, E14  
 230 V  
 ⚡ 460 ø160 mm  
 EAN 4000870 796580  
**796.58 new**

- ⚡ Matt white/Matt copper
- 🔲 Metal
- 🔲 Blanco mate/Cobre mate
- 🔲 Metal
- 🔲 Bianco opaco/Rame opaco
- 🔲 Metallo





**2**  
 283.69  
 283.70  
 284.41

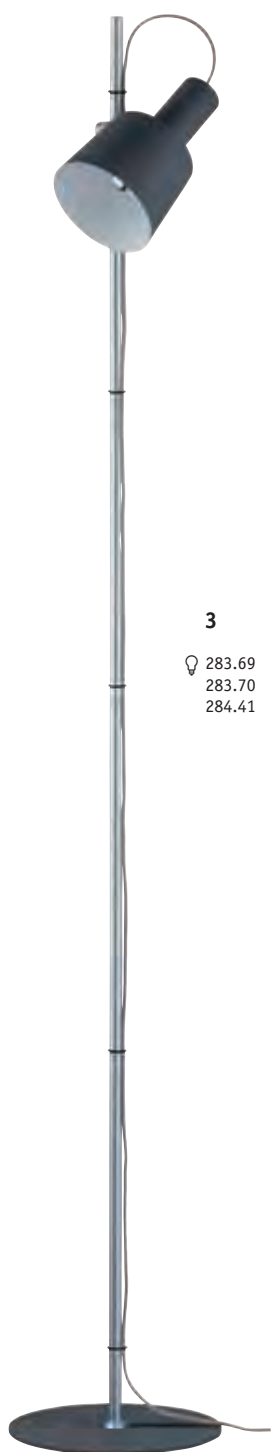

**3**  
 283.69  
 283.70  
 284.41



**4**  
 283.69  
 283.70  
 284.41



**1**  
 283.69  
 283.70  
 284.41  
 285.01  
 285.04

**1 Haldar** A++-E  
 max. 20 W, E14  
 230 V  
 ∅172 cm ∅120 mm  
 EAN 4000870 796917  
**796.91 new**

**2 Haldar** A++-E  
 max. 2x20 W, E14  
 230 V  
 ∅1.520 ∅230 mm  
 EAN 4000870 796900  
**796.90 new**

**3 Haldar** A++-E  
 max. 20 W, E14  
 230 V  
 ∅1.520 ∅230 mm  
 EAN 4000870 796924  
**796.92 new**

**4 Haldar** A++-E  
 max. 20 W, E14  
 230 V  
 ∅460 ∅160 mm  
 EAN 4000870 796894  
**796.89 new**

- Dark grey/Chrome matt Metal
- Gris oscuro/Cromo mate Metal
- Grigio scuro/Cromo opaco Metallo



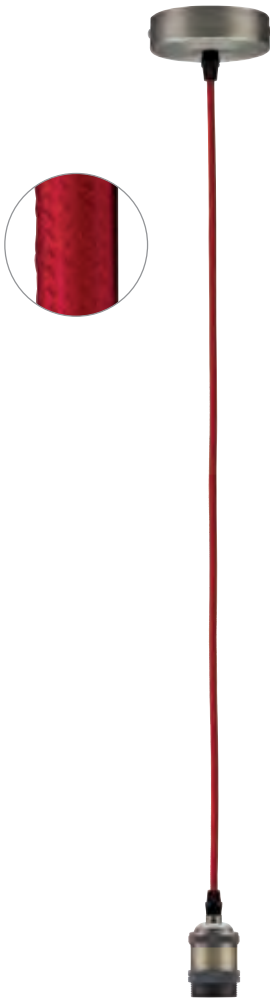

1

- 283.79
- 283.80
- 283.81
- 283.88
- 283.95
- 283.89
- 283.90
- 283.91
- 283.92
- 283.93
- 283.94



2

- 283.79
- 283.80
- 283.81
- 283.88
- 283.95
- 283.89
- 283.90
- 283.91
- 283.92
- 283.93
- 283.94

**1 Pendulum** A++-E

max. 60 W, E27  
 230 V  
 ⚡70 mm ⚡200 cm ø45 mm  
 EAN 4000870 503232  
**503.23** **new**

- 🔗 Red/Brushed nickel Metal
- 🔗 Rojo/Níquel mateado Metal
- 🔗 Rosso/Nichel spazzolato Metallo

**2 Pendulum** A++-E

max. 60 W, E27  
 230 V  
 ⚡70 mm ⚡200 cm ø45 mm  
 EAN 4000870 503225  
**503.22** **new**

- 🔗 Grey/Brushed nickel Metal
- 🔗 Gris/Níquel mateado Metal
- 🔗 Grigio/Nichel spazzolato Metallo



**5 Canopy** A++-E

max. 60 W, E27  
 230 V  
 ⚡200 cm ø200 mm  
 EAN 4000870 503416  
**503.41** **new**

- 🔗 White Metal
- 🔗 Blanco Metal
- 🔗 Bianco Metallo



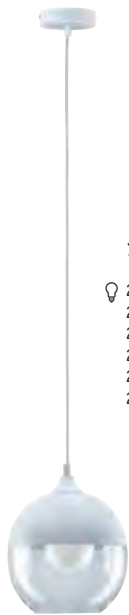

**1**  
 ⚡ 284.86  
 282.10  
 283.31  
 283.32  
 284.56  
 284.81

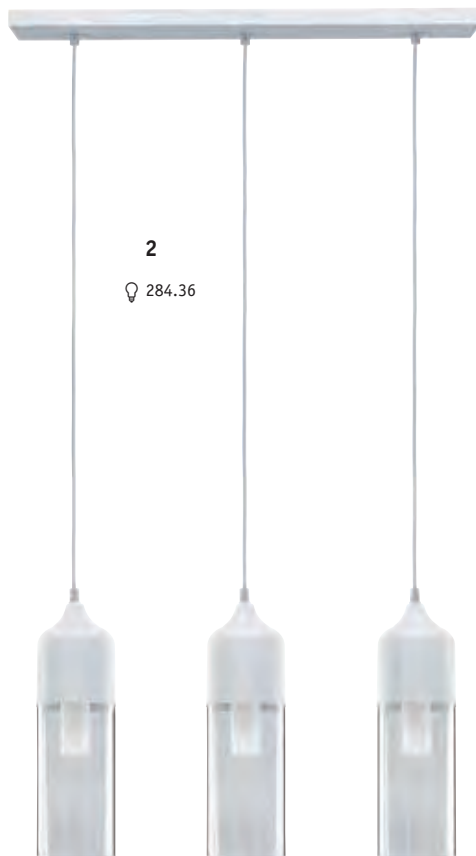

**2**  
 ⚡ 284.36



**3**  
 ⚡ 284.36



**4**  
 ⚡ 284.86  
 283.75  
 283.31  
 283.32  
 282.10  
 284.81

**1 Vanja** A++-E  
 max. 20 W, E27  
 230 V  
 ⚡ 145 cm ø200 mm  
 EAN 4000870 796443  
**796.44 new**

**2 Vanja** A++-E  
 max. 3×20 W, E27  
 230 V  
 ⚡ 155 cm ↔ 600 mm ↻100 mm  
 EAN 4000870 796436  
**796.43 new**

🌀 Matt white/Clear 🗍 Glass/Metal  
 🌀 Blanco mate/Transparente 🗍 Cristal/Metal  
 🌀 Bianco opaco/Trasparente 🗍 Vetro/Metallo

**3 Vanja** A++-E  
 max. 3×20 W, E27  
 230 V  
 ⚡ 155 cm ↔ 600 mm ↻100 mm  
 EAN 4000870 796429  
**796.42 new**

**4 Vanja** A++-E  
 max. 20 W, E27  
 230 V  
 ⚡ 145 cm ø200 mm  
 EAN 4000870 796450  
**796.45 new**

🌀 Grey/Clear 🗍 Glass/Metal  
 🌀 Gris/Transparente 🗍 Cristal/Metal  
 🌀 Grigio/Trasparente 🗍 Vetro/Metallo

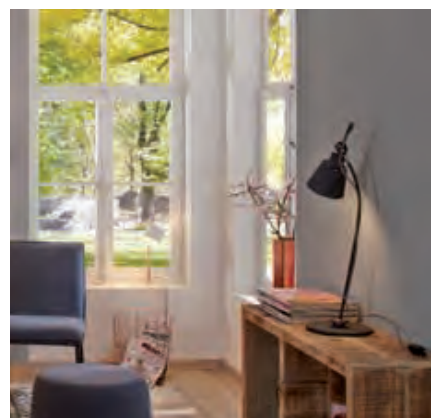

**1 Thala** A++-E

max. 20 W, E14  
230 V  
∅640 ∅200 mm  
EAN 4000870 796832

**796.83 new**

- 🔩 Chrome matt ██ Metal
- 🔩 Cromo mate ██ Metal
- 🔩 Cromo opaco ██ Metallo



**2 Thala** A++-E

max. 20 W, E14  
230 V  
∅1.410 ∅300 mm  
EAN 4000870 796825

**796.82 new**

- 🔩 Grey ██ Metal
- 🔩 Gris ██ Metal
- 🔩 Grigio ██ Metallo



**1**

💡 283.70  
284.41



**2**

💡 283.70  
284.41







1

💡 282.10  
283.31  
283.32  
283.77  
283.78  
284.23

3

💡 283.31  
283.32  
283.77  
283.78

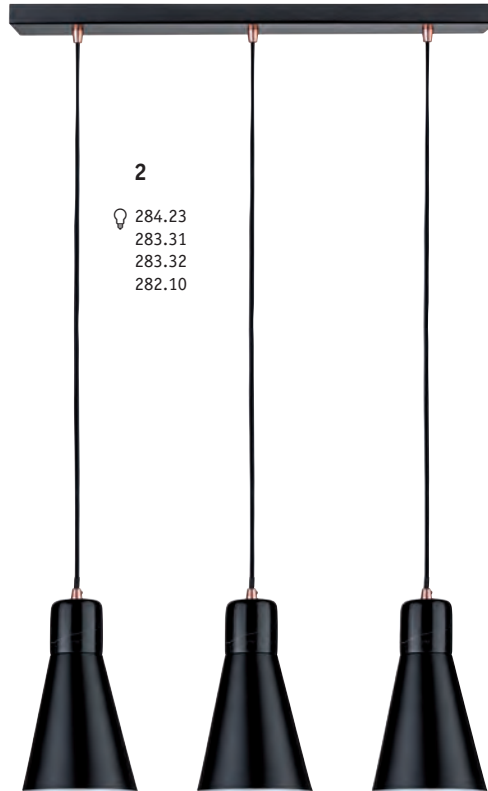

2

💡 284.23  
283.31  
283.32  
282.10

4

💡 283.38

5

💡 283.38

1 **Roald** A++-E

max. 20 W, E27  
230 V  
⤴ 156 cm ⌀260 mm  
EAN 4000870 796092  
**796.09 new**

💡 Black matt/Matt copper  
📊 Metal/Marble  
💡 Negro mate/Cobre mate  
📊 Metal/Mármol  
💡 Nero opaco/Rame opaco  
📊 Metallo/Marmo

2 **Ivar** A++-E

max. 3×20 W, E27  
230 V  
⤴ 147 cm ⇄ 600 mm ↻100 mm  
EAN 4000870 796085  
**796.08 new**

💡 Black matt/Matt copper  
📊 Metal/Marble  
💡 Negro mate/Cobre mate  
📊 Metal/Mármol  
💡 Nero opaco/Rame opaco  
📊 Metallo/Marmo

3 **Enja** A++-E

max. 20 W, E27  
230 V  
⤴ 1.600 ⌀245 mm  
EAN 4000870 796122  
**796.12 new**

💡 Black/Copper 📊 Fabric/Marble/  
Metal  
💡 Negro/Cobre 📊 Tela/Mármol/  
Metal  
💡 Nero/Rame 📊 Tessuto/Marmo/  
Metallo

4 **Moa** A++-E

max. 10 W, G9  
230 V  
⤴ 400 ⌀100 mm  
EAN 4000870 796627  
**796.62 new**

💡 White/Black/Matt copper  
📊 Glass/Marble/Metal  
💡 Blanco/Negro/Cobre mate  
📊 Cristal/Mármol/Metal  
💡 Bianco/Nero/Rame opaco  
📊 Vetro/Marmo/Metallo

5 **Moa** A++-E

max. 20 W, G9  
230 V  
⤴ 400 ⌀100 mm  
EAN 4000870 796887  
**796.88 new**

💡 Black/Chrome matt 📊 Glass/  
Marble/Metal  
💡 Negro/Cromo mate 📊 Cristal/  
Mármol/Metal  
💡 Nero/Cromo opaco 📊 Vetro/  
Marmo/Metallo





1

284.57  
283.79  
283.88  
283.87  
283.93  
283.94  
284.23  
284.24  
284.25



2

284.57  
283.79  
283.88  
283.87  
283.93  
283.94

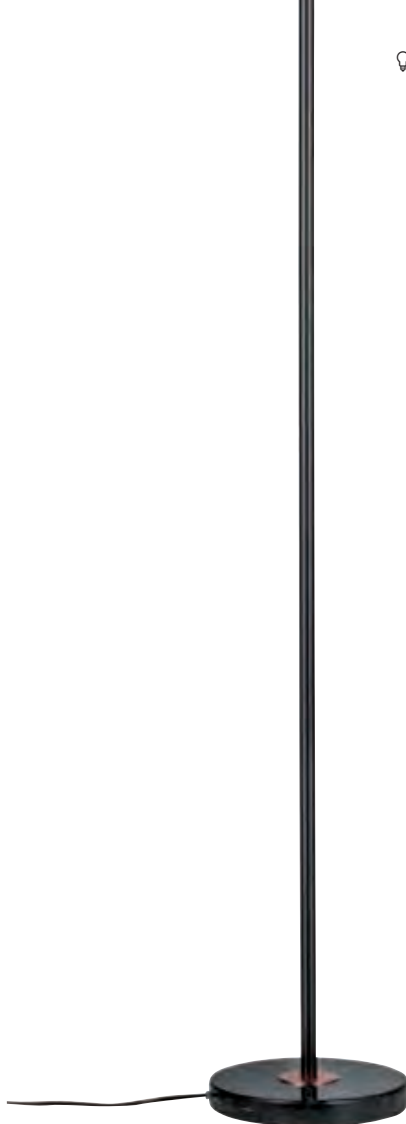

3

283.79  
283.87  
283.88  
283.93  
283.94  
284.57



1 **Nordin** A++-E

max. 20 W, E27  
230 V  
190 cm ø100 mm  
EAN 4000870 796054  
**796.05 new**

Black/Matt copper Marble/Metal  
Negro/Cobre mate Mármol/Metal  
Nero/Rame opaco Marmo/Metallo

2 **Nordin** A++-E

max. 20 W, E27  
230 V  
1.200 ø200 mm  
EAN 4000870 796146  
**796.14 new**

Black/Matt copper Marble/Metal  
Negro/Cobre mate Mármol/Metal  
Nero/Rame opaco Marmo/Metallo

3 **Nordin** A++-E







max. 20 W, E27  
230 V  
130 ø95 mm  
EAN 4000870 796009  
**796.00 new**

Black Marble  
Negro Mármol  
Nero Marmo

**1 Pendulum**

max. 60 W, E27  
230 V  
±200 cm ø52 mm  
EAN 4000870 503355  
**503.35**  **new**



 Gold/Alabaster  Metal/Plastic  
 Oro/Alabastro  Metal/Plástico  
 Oro/Alabastro  Metallo/Plastica



**1**  
 283.79  
283.80  
283.81  
283.88  
283.89  
283.90  
283.91  
283.92  
283.93  
283.94  
283.95









**3**  
 283.79  
283.87  
283.88  
283.93  
283.94  
284.23  
284.24  
284.25  
284.57

**2 Nordin**

max. 20 W, E27  
230 V  
±1.200 ø200 mm  
EAN 4000870 796153  
**796.15**  **new**



 White/Gold matt  Marble/Metal  
 Blanco/Oro mate  Mármol/Metal  
 Bianco/Oro opaco  Marmo/Metallo









**2**  
 283.79  
283.87  
283.88  
283.93  
283.94  
284.57

**3 Nordin**

max. 20 W, E27  
230 V  
±190 cm ø100 mm  
EAN 4000870 796047  
**796.04**  **new**



 White/Gold matt  Marble/Metal  
 Blanco/Oro mate  Mármol/Metal  
 Bianco/Oro opaco  Marmo/Metallo



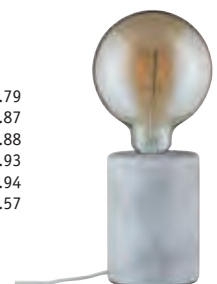



**4**  
 283.79  
283.87  
283.88  
283.93  
283.94  
284.57



**4 Nordin**

max. 20 W, E27  
230 V  
±130 ø95 mm  
EAN 4000870 796016  
**796.01**  **new**



 White  Marble  
 Blanco  Mármol  
 Bianco  Marmo











**1**  
 284.23  
 283.31  
 283.32  
 282.10

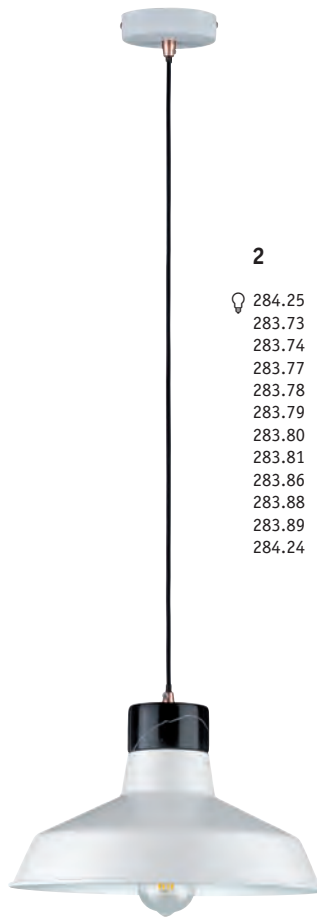

**2**  
 284.25  
 283.73  
 283.74  
 283.77  
 283.78  
 283.79  
 283.80  
 283.81  
 283.86  
 283.88  
 283.89  
 284.24

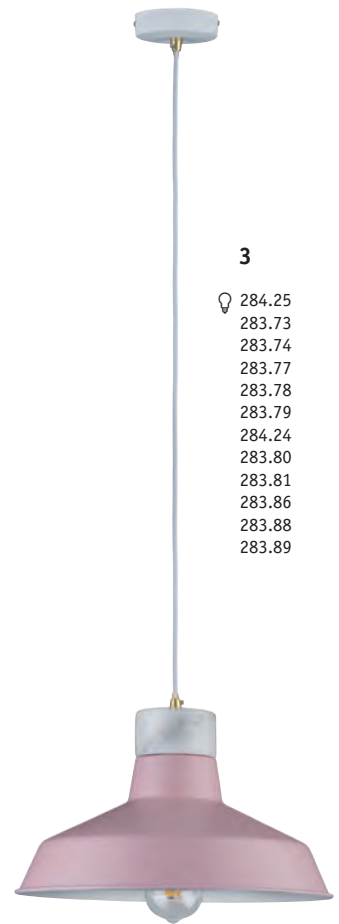

**3**  
 284.25  
 283.73  
 283.74  
 283.77  
 283.78  
 283.79  
 284.24  
 283.80  
 283.81  
 283.86  
 283.88  
 283.89

**1 Maiga**

max. 20 W, E27  
 230 V  
 140 cm ø230 mm

EAN 4000870 796061

**796.06 new**

- 🌀 Matt white/Black/Gold matt
- 🌀 Blanco mate/Negro/Oro mate
- 🌀 Bianco opaco/Nero/Oro opaco

A++-E



**2 Disa**

max. 20 W, E27  
 230 V  
 143 cm ø350 mm

EAN 4000870 796078

**796.07 new**

- 🌀 Matt white/Black/Matt copper
- 🌀 Blanco mate/Negro/Cobre mate
- 🌀 Bianco opaco/Nero/Rame opaco

A++-E



**3 Disa**

max. 20 W, E27  
 230 V  
 143 cm ø350 mm

EAN 4000870 796108

**796.10 new**

- 🌀 Pink/Matt white/Gold matt
- 🌀 Rosa/Blanco mate/Oro mate
- 🌀 Rosa/Bianco opaco/Oro opaco

A++-E



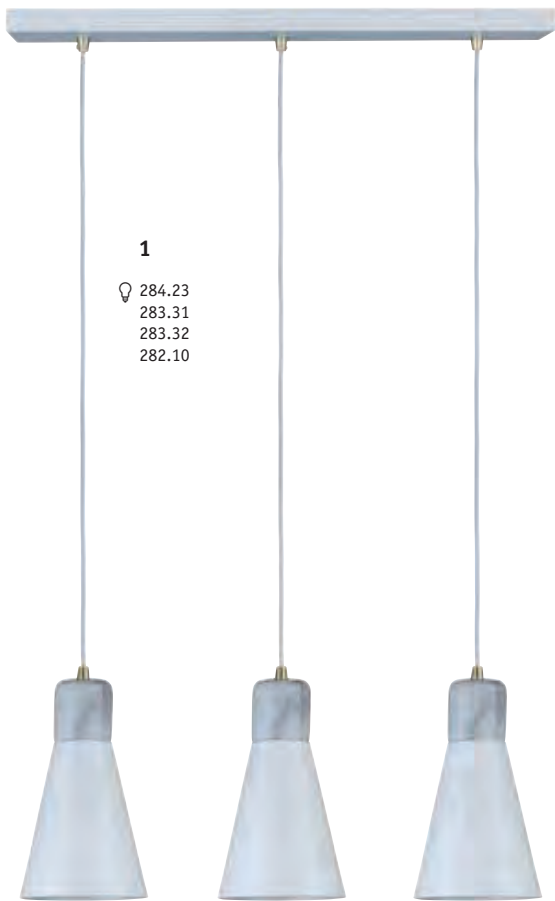

1

💡 284.23  
283.31  
283.32  
282.10

**1 Ivar**

A++-E

max. 3×20 W, E27  
230 V  
⏏ 147 cm ↔ 600 mm ↗ 100 mm

EAN 4000870 796115

**796.11 new**

- 🌀 Matt white/Gold matt 🏠 Metal/Marble
- 🌀 Blanco mate/Oro mate 🏠 Metal/Mármol
- 🌀 Bianco opaco/Oro opaco 🏠 Metallo/Marmo



3

💡 283.31  
283.32  
283.77  
283.78

**2 Moa**

A++-E

max. 10 W, G9  
230 V  
⏏ 400 ø100 mm

EAN 4000870 796610

**796.61 new**

- 🌀 White/Gold matt 🏠 Glass/Marble/Metal
- 🌀 Blanco/Oro mate 🏠 Cristal/Mármol/Metal
- 🌀 Bianco/Oro opaco 🏠 Vetro/Marmo/Metallo



2

💡 283.38

**3 Enja**

A++-E

max. 20 W, E27  
230 V  
⏏ 1.600 ø245 mm

EAN 4000870 796139

**796.13 new**

- 🌀 White/Gold 🏠 Fabric/Marble/Metal
- 🌀 Blanco/Oro 🏠 Tela/Mármol/Metal
- 🌀 Bianco/Oro 🏠 Tessuto/Marmo/Metallo







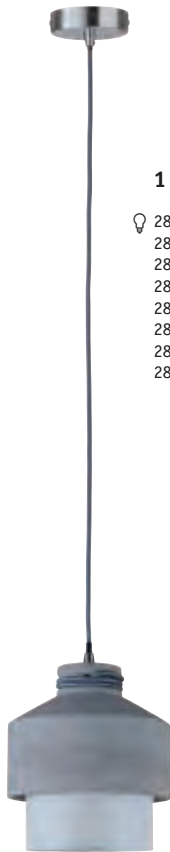

1

282.10  
283.31  
283.32  
283.75  
283.76  
283.77  
283.78  
284.23



2

283.28  
283.90  
283.91  
283.92  
283.93  
283.94  
283.95  
284.25  
284.36

**1 Helin** A++-E  
max. 20 W, E27  
230 V  
175 cm ø190 mm  
EAN 4000870 796160  
**796.16 new**

Grey/Satin Concrete/Glass  
Gris/Satinado Hormigón/Cristal  
Grigio/Satinato Cemento/Vetro

**2 Henja** A++-E  
max. 20 W, E27  
230 V  
191 cm ø120 mm  
EAN 4000870 796184  
**796.18 new**

Grey/Brushed iron Concrete/Metal  
Gris/Hierro mateado Hormigón/Metal  
Grigio/Ferro spazzolato Cemento/  
Metallo



3

283.31  
283.32  
283.75  
283.76

**3 Helin** A++-E  
max. 20 W, E27  
230 V  
250 ø160 mm  
EAN 4000870 796191  
**796.19 new**

Grey/Satin Concrete/Glass  
Gris/Satinado Hormigón/Cristal  
Grigio/Satinato Cemento/Vetro



**1 Pendulum**

max. 60 W, E27  
230 V  
⌆200 cm ⌀50 mm  
EAN 4000870 503324



🔗 Grey/Black 🧱 Concrete/Plastic  
🔗 Gris/Negro 🧱 Hormigón/Plástico  
🔗 Grigio/Nero 🧱 Cemento/Plastica

- 💡 283.79
- 283.80
- 283.81
- 283.88
- 283.95
- 283.89
- 283.90
- 283.91
- 283.92
- 283.93
- 283.94



**2 Mik**

max. 20 W, E27  
230 V  
⌆130 ⌀220 mm  
EAN 4000870 796214



🔗 Grey 🧱 Concrete  
🔗 Gris 🧱 Hormigón  
🔗 Grigio 🧱 Cemento

**3 Ingram**

max. 20 W, E27  
230 V  
⌆215 ⌀230 mm  
EAN 4000870 796634



🔗 Grey 🧱 Concrete  
🔗 Gris 🧱 Hormigón  
🔗 Grigio 🧱 Cemento



**2**

- 💡 283.87
- 283.76
- 283.88
- 284.57
- 283.79
- 283.93
- 283.94



**3**

- 💡 283.76
- 283.73
- 283.77
- 284.56



1

⦿ 282.10  
283.31  
283.32  
283.77  
283.78  
284.23

2

⦿ 282.10  
283.31  
283.32  
283.77  
283.78  
284.23



**1 Stig** A++-E  
 max. 20 W, E27   
 230 V   
 ⚙ 170 cm ø120 mm   
 EAN 4000870 796177  
**796.17 new**

**2 Stig** A++-E  
 max. 3×20 W, E27   
 230 V   
 ⚙ 170 cm ⇔ 600 mm ↻ 100 mm   
 EAN 4000870 796269  
**796.26 new**

🌀 Grey/Matt copper  Concrete/  
 Metal  
 🌀 Gris/Cobre mate  Hormigón/  
 Metal  
 🌀 Grigio/Rame opaco  Cemento/  
 Metallo



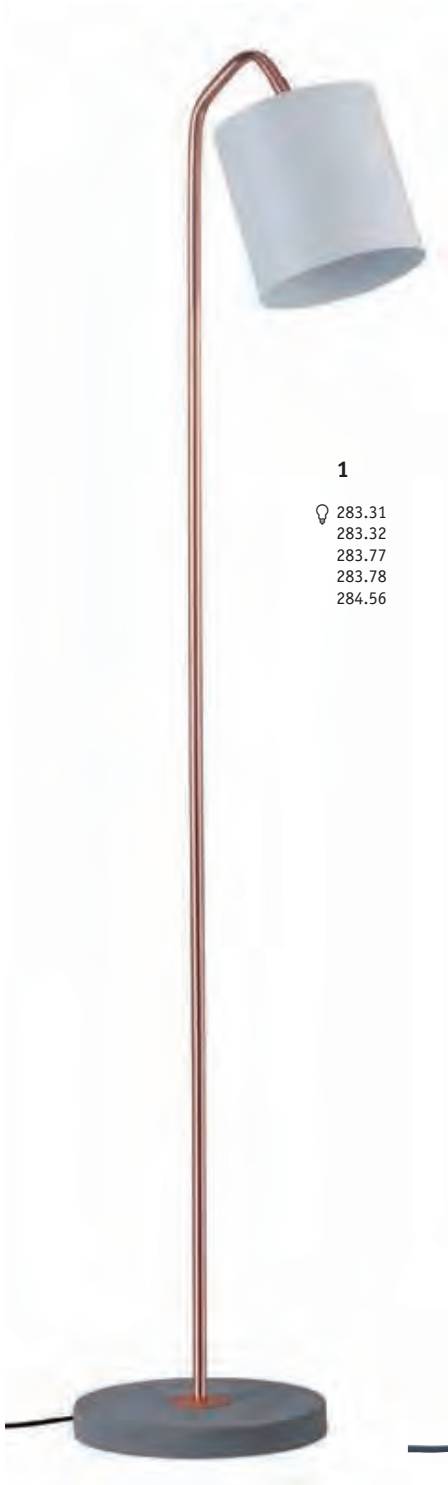

1

- 💡 283.31
- 283.32
- 283.77
- 283.78
- 284.56



2

- 💡 283.31
- 283.32
- 283.77
- 283.78

**1 Oda**

A++-E

max. 20 W, E27  
230 V

📏 1.370 ø250 mm

EAN 4000870 796252

**796.25 new**



🎨 Matt white/Matt copper/Grey  
🏠 Metal/Concrete  
🎨 Blanco mate/Cobre mate/Gris  
🏠 Metal/Hormigón  
🎨 Bianco opaco/Rame opaco/  
Grigio 🏠 Metallo/Cemento

**2 Tem**

A++-E

max. 20 W, E27  
230 V

📏 340 ø220 mm

EAN 4000870 796221

**796.22 new**



🎨 Grey/Copper 🏠 Fabric/Concrete/  
Metal  
🎨 Gris/Cobre 🏠 Tela/Hormigón/  
Metal  
🎨 Grigio/Rame 🏠 Tessuto/  
Cemento/Metallo



1 **Norell**

A++-E

max. 3x20 W, E27

230 V

↑170 cm ø200 mm ↗100 mm

EAN 4000870 796276

**796.27 new**

- 🌀 Grey/Matt white/Gold matt
- 🏠 Concrete/Metal
- 🌀 Gris/Blanco mate/Oro mate
- 🏠 Hormigón/Metal
- 🌀 Grigio/Bianco opaco/Oro opaco
- 🏠 Cemento/Metallo



1

- 💡 282.10
- 283.31
- 283.32
- 283.77
- 283.78
- 284.23



2

- 💡 283.88
- 284.56



2 **Yorik**

A++-E

max. 20 W, E27

230 V

↑350 ø200 mm

EAN 4000870 796658

**796.65 new**

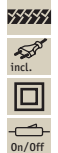

- 🌀 Clear/Grey/Copper 🏠 Glass/Concrete/Metal
- 🌀 Transparente/Gris/Cobre
- 🏠 Cristal/Hormigón/Metal
- 🌀 Trasparente/Grigio/Rame
- 🏠 Vetro/Cemento/Metallo

3 **Orm**

A++-E

max. 20 W, E27

230 V

↑500 ø150 mm

EAN 4000870 796245

**796.24 new**



- 🌀 Grey/Matt copper 🏠 Metal/Concrete
- 🌀 Gris/Cobre mate 🏠 Metal/Hormigón
- 🌀 Grigio/Rame opaco 🏠 Metallo/Cemento

4 **Orm**

A++-E

max. 20 W, E27

230 V

↑500 ø150 mm

EAN 4000870 796238

**796.23 new**



- 🌀 Matt white/Gold matt/Grey
- 🏠 Metal/Concrete
- 🌀 Blanco mate/Oro mate/Gris
- 🏠 Metal/Hormigón
- 🌀 Bianco opaco/Oro opaco/Grigio
- 🏠 Metallo/Cemento

3

- 💡 283.31
- 283.32
- 283.77
- 283.78
- 284.56

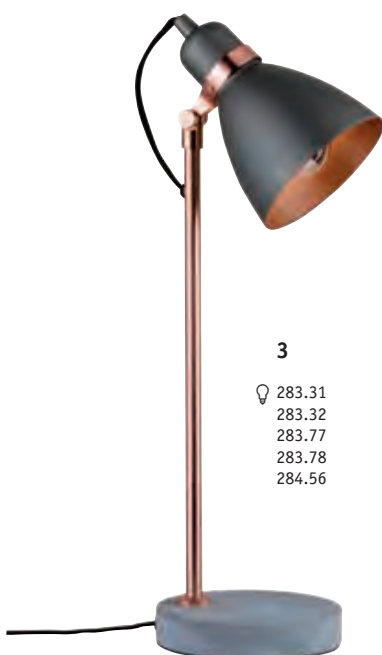

4

- 💡 283.31
- 283.32
- 283.77
- 283.78

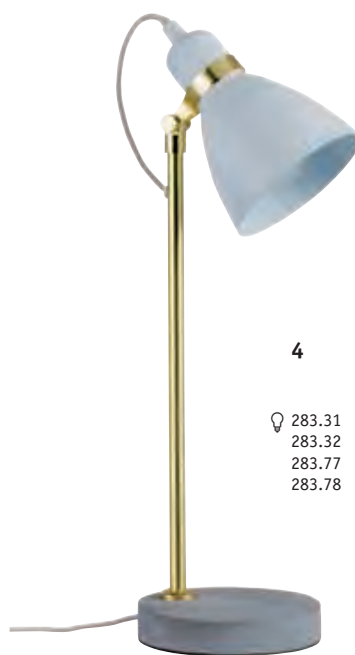



# OLED

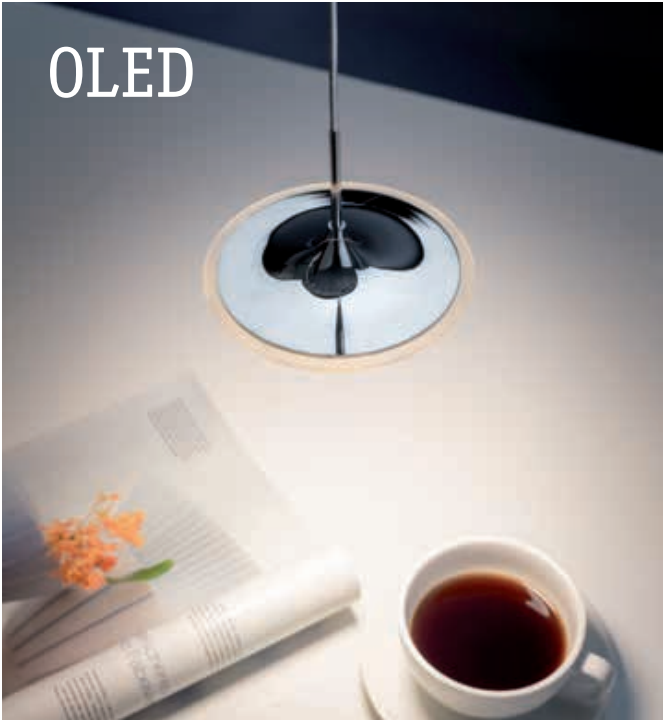

**1 OLED Bell** A++-A  
 incl. 1x2,2 W OLED  
 65 lm, 3.000 K  
 230V, incl. 10 VA □  
 ⌀87 mm ⌀205 cm ø135 mm ⌘  
 EAN 4000870 941294

**941.29 new**

**2 OLED Bell** A++-A  
 incl. 1x2,2 W OLED  
 65 lm, 3.000 K  
 DC 12 V ◇  
 ⌀87 mm ⌀205 cm ø135 mm ⌘  
 EAN 4000870 941300

**941.30 new**

🌀 Chrome/White 🗍 Metal/Plastic  
 🌀 Cromo/Blanco 🗍 Metal/Plástico  
 🌀 Cromo/Bianco 🗍 Metallo/Plastica

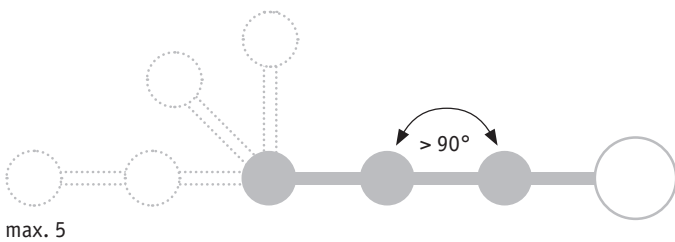
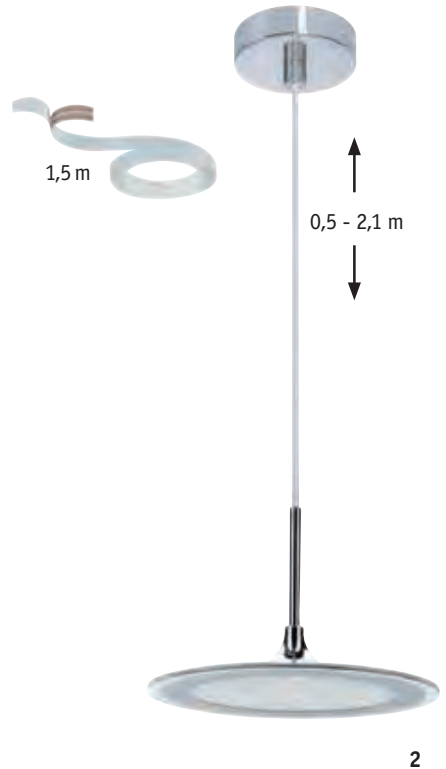
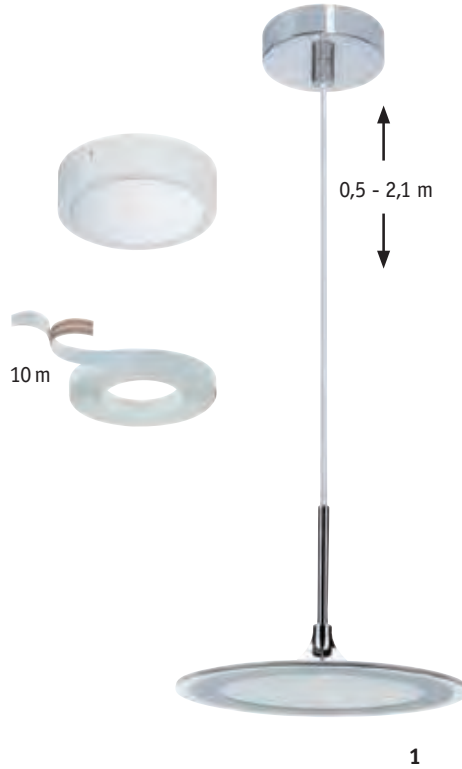

# 3D Glass

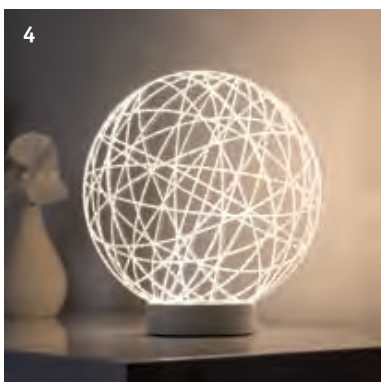
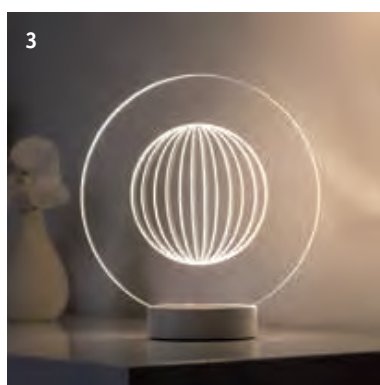

### 1 3D Mesh Glass

∅230 ∅10 mm  
EAN 4000870 795347  
**795.34 new**



### 2 3D Maze Glass

∅230 ∅10 mm  
EAN 4000870 795323  
**795.32 new**



### 3 3D Yarn Glass

∅230 ∅10 mm  
EAN 4000870 795316  
**795.31 new**



### 4 3D Wool Glass

∅230 ∅10 mm  
EAN 4000870 795330  
**795.33 new**



### 5 3D Twine Glass

∅230 ∅10 mm  
EAN 4000870 795378  
**795.37 new**

Clear Acrylic  
Transparente Acrílico  
Trasparente Acrilico

**3D Basic** A++-A

incl. 1×3W  
270 lm  
230V, incl. 4 VA  
∅33 ∅104 ∅10 mm  
EAN 4000870 795354  
**795.35 new**

LED  
incl.  
On/Off



Matt white Aluminium  
Blanco mate Aluminio  
Bianco opaco Alluminio

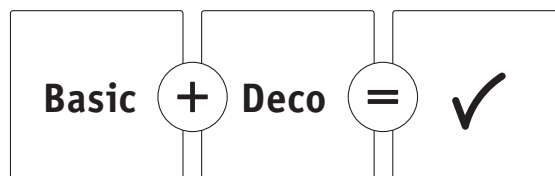







⌘ Satin nickel/Opal/Brown 🗪 Metal/Glass  
 ⌘ Níquel satinado/Opal/Marrón 🗪 Metal/Cristal  
 ⌘ Nichel satinato/Opale/Marrone 🗪 Metallo/Vetro

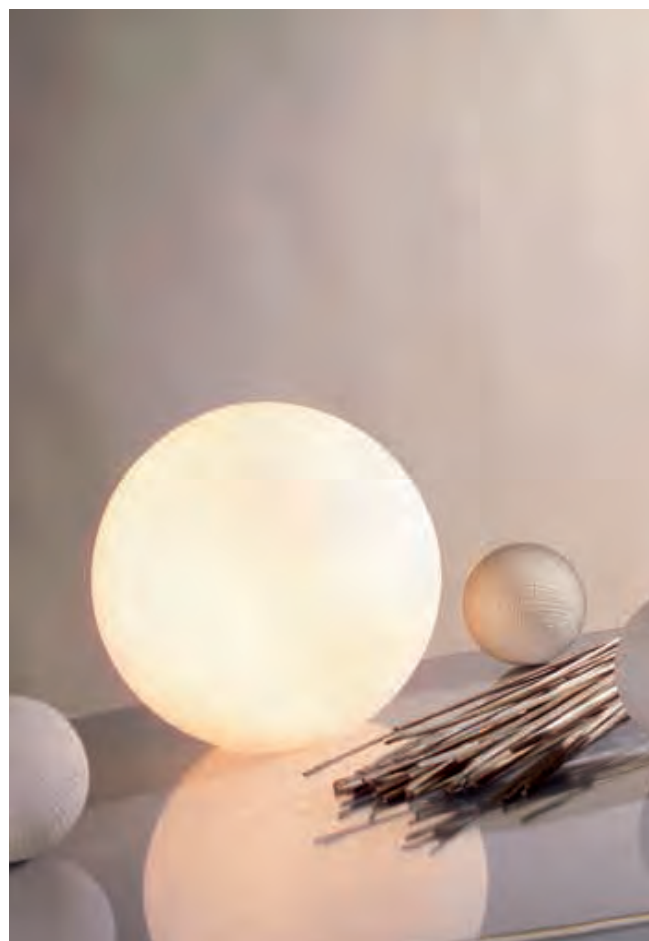

⌘ Opal 🗪 Glass  
 ⌘ Opal 🗪 Cristal  
 ⌘ Opale 🗪 Vetro



**Giba** A++-E  
 max. 25 W, E14  
 230 V  
 ⌀140 ø150 mm  
 EAN 4000870 660522  
**660.52**  
 ⚡ 894.35  
 283.70



**Kia** A++-E  
 max. 40 W, E14  
 230 V  
 ⌀195 ø200 mm  
 EAN 4000870 770320  
**770.32**  
 ⚡ 283.63  
 283.70  
 314.66







**Vilma**

A++-E

max. 40 W, E14  
230 V  
∅200 ⇄100 ↗100 mm  
EAN 4000870 770313  
**770.31**



💡 314.66  
894.35  
283.70  
283.63

👉 Opal 🏠 Glass  
👉 Opal 🏠 Cristal  
👉 Opale 🏠 Vetro



**Jenni**

A++-E

max. 40 W, E14  
230 V  
∅220 ⇄100 ↗100 mm  
EAN 4000870 770375  
**770.37**



💡 314.66

👉 Satin nickel/Opal 🏠 Metal/  
Glass  
👉 Níquel satinado/Opal 🏠 Metal/  
Cristal  
👉 Nichel satinato/Opale  
🏠 Metallo/Vetro



**Pinja**

A++-E

max. 40 W, E14  
230 V  
∅240 ø110 mm  
EAN 4000870 770290  
**770.29**



💡 314.66

👉 Chrome/Opal 🏠 Metal/Glass  
👉 Cromo/Opal 🏠 Metal/Cristal  
👉 Cromo/Opale 🏠 Metallo/Vetro



**Noora**

A++-E

max. 42 W, E14  
230 V  
∅210 ø80 mm  
EAN 4000870 770108  
**770.10**



💡 894.39  
283.70  
283.63

👉 Opal 🏠 Glass  
👉 Opal 🏠 Cristal  
👉 Opale 🏠 Vetro

**Milla**

A++-E

max. 60 W, E14  
230 V  
∅400 ∅130 mm  
EAN 4000870 770153  
**770.15**  
314.67

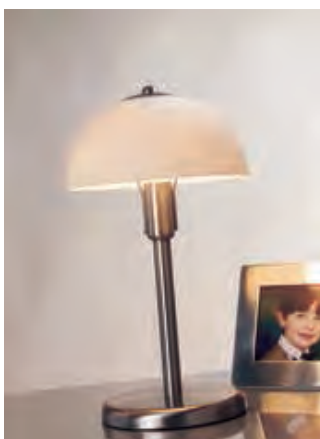

Brushed nickel/Satin Metal/  
Glass  
Níquel mateado/Satinado  
Metal/Cristal  
Nichel spazzolato/Satinato  
Metallo/Vetro

**Ella**

A++-E

max. 40 W, E14  
230 V  
∅360 ∅200 mm  
EAN 4000870 770184  
**770.18**  
314.66  
283.70



Brushed nickel/Opal Metal/  
Glass  
Níquel mateado/Opal Metal/  
Cristal  
Nichel spazzolato/Opale  
Metallo/Vetro

**Saro**

A++-E

max. 40 W, E14  
230 V  
∅375 ∅200 mm  
EAN 4000870 701799  
**701.79**  
314.66



Brushed iron/White Metal/  
Fabric  
Hierro mateado/Blanco  
Metal/Tela  
Ferro spazzolato/Bianco  
Metallo/Tessuto



**Move LED**

A++-A

incl. 1x5 W  
188 lm, 2.900 K  
230 V  
±565 ↔535 ↗200 mm  
EAN 4000870 702482

**702.48**

- 🔩 Black/Chrome matt
- 🔩 Soft finish/Plastic/Metal
- 🔩 Negro/Cromo mate
- 🔩 Pintura soft touch/Plástico/Metal
- 🔩 Nero/Cromo opaco
- 🔩 Vernice soft touch/Plastica/Metallo



**Plaza**

A++-A

incl. 1x3 W  
240 lm, 6.000 - 7.000 K  
∠ 120°  
230 V  
±750 ø250 mm  
EAN 4000870 749944

**749.94**

- 🔩 Chrome Metal
- 🔩 Cromo Metal
- 🔩 Cromo Metallo



**Plaza**

A++-A

incl. 1x3 W  
240 lm, 6.000 - 7.000 K  
∠ 120°  
230 V  
±750 ø250 mm  
EAN 4000870 749951

**749.95**

- 🔩 Brushed iron Metal
- 🔩 Hierro mateado Metal
- 🔩 Ferro spazzolato Metallo



**Zed LED**

A++-A

incl. 1x6,7 W  
359 lm, 3.000 K  
230 V  
±475 ø160 mm  
EAN 4000870 702451

**702.45**

- 🔩 Brushed iron Metal
- 🔩 Hierro mateado Metal
- 🔩 Ferro spazzolato Metallo



**Enjoy LED**

A++-A

incl. 1x3,3 W

6.500 K

230 V

⌀365 ⇄350 ↗45 mm

EAN 4000870 793923

**793.92**

☞ Aluminium/Transparent

☒ Metal/Plastic

☞ Alumínio/Transparente

☒ Metal/Plástico

☞ Alluminio/Trasparente

☒ Metallo/Plastica

LED

incl.

On/Off

On/Off

On/Off

On/Off

**Work LED**

A++-A

incl. 1x2,4 W

6.500 - 7.000 K

230 V

⌀585 ⇄110 ↗65 mm

EAN 4000870 793916

**793.91**

☞ Chrome ☒ Metal

☞ Cromo ☒ Metal

☞ Cromo ☒ Metallo

LED

incl.

On/Off

On/Off

On/Off

On/Off

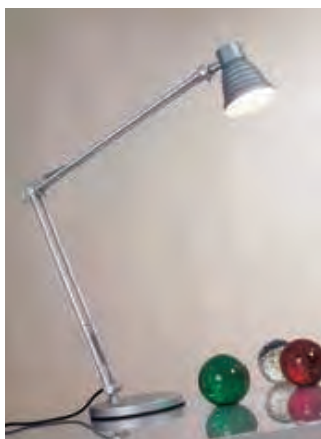
**Sara**

A++-E

max. 60 W, E14

230 V

⌀980 ø180 mm

EAN 4000870 770252

**770.25**

☞ 284.41

☞ 284.42

☞ Silver ☒ Metal

☞ Plateado ☒ Metal

☞ Argento ☒ Metallo

incl.

On/Off

On/Off

On/Off

# Galeria

- 89 Galeria
- 94 Mirror
- 96 Assistent



91 Galeria Remus



92 Galeria Double Bow







☞ White/Chrome ☒ Metal  
 ☞ Blanco/Cromo ☒ Metal  
 ☞ Bianco/Cromo ☒ Metallo



#### Beam Thirty A++-A

incl. 1×5 W  
 630 lm, 2.700 K  
 ∠ 100°, 220 cd  
 230 V  
 ⌀46 ⇄290 ↗190 mm  
 EAN 4000870 998915  
**998.91**

LED



#### Beam Fifty A++-A

incl. 1×7 W  
 850 lm, 2.700 K  
 ∠ 100°, 350 cd  
 230 V  
 ⌀46 ⇄450 ↗190 mm  
 EAN 4000870 998922  
**998.92**

LED



#### Beam Sixty A++-A

incl. 1×11 W  
 1.250 lm, 2.700 K  
 ∠ 100°, 430 cd  
 230 V  
 ⌀46 ⇄585 ↗190 mm  
 EAN 4000870 998939  
**998.93**

LED



☞ Brushed nickel/Chrome ☒ Metal  
 ☞ Níquel mateado/Cromo ☒ Metal  
 ☞ Nichel spazzolato/Cromo ☒ Metallo



#### Beam Thirty A++-A

incl. 1×5 W  
 630 lm, 2.700 K  
 ∠ 100°, 220 cd  
 230 V  
 ⌀46 ⇄290 ↗190 mm  
 EAN 4000870 998946  
**998.94**

LED



#### Beam Fifty A++-A

incl. 1×7 W  
 850 lm, 2.700 K  
 ∠ 100°, 350 cd  
 230 V  
 ⌀46 ⇄450 ↗190 mm  
 EAN 4000870 998953  
**998.95**

LED



#### Beam Sixty A++-A

incl. 1×11 W  
 1.250 lm, 2.700 K  
 ∠ 100°, 430 cd  
 230 V  
 ⌀46 ⇄585 ↗190 mm  
 EAN 4000870 998960  
**998.96**

LED





Chrome Metal  
 Cromo Metal  
 Cromo Metallo



**Beam Thirty** A++-A  
 incl. 1x5 W LED  
 630 lm, 2.700 K  
 <math>\sphericalangle 100^\circ</math>, 220 cd  
 230 V  
 $\updownarrow 46 \leftrightarrow 290 \curvearrowright 190$  mm  
 EAN 4000870 998885  
**998.88**

**Beam Fifty** A++-A  
 incl. 1x7 W LED  
 850 lm, 2.700 K  
 <math>\sphericalangle 100^\circ</math>, 350 cd  
 230 V  
 $\updownarrow 46 \leftrightarrow 450 \curvearrowright 190$  mm  
 EAN 4000870 998892  
**998.89**

**Beam Sixty** A++-A  
 incl. 1x11 W LED  
 1.250 lm, 2.700 K  
 <math>\sphericalangle 100^\circ</math>, 430 cd  
 230 V  
 $\updownarrow 46 \leftrightarrow 585 \curvearrowright 190$  mm  
 EAN 4000870 998908  
**998.90**

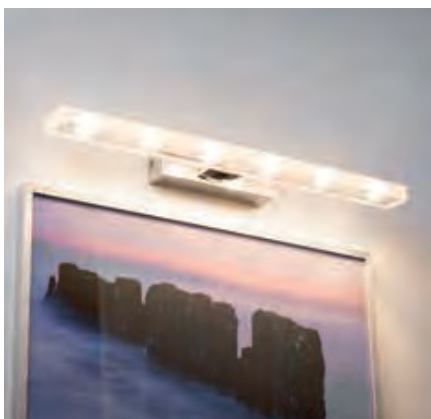

Chrome/Transparent Metal/Acrylic  
 Cromo/Transparente Metal/Acrilico  
 Cromo/Trasparente Metallo/Acrilico



**Block** A++-A  
 incl. 1x5 W LED  
 420 lm, 2.700 K  
 230 V  
 $\updownarrow 46 \leftrightarrow 335 \curvearrowright 95$  mm  
 EAN 4000870 998977  
**998.97**

**Block** A++-A  
 incl. 1x7 W LED  
 640 lm, 2.700 K  
 230 V  
 $\updownarrow 46 \leftrightarrow 505 \curvearrowright 95$  mm  
 EAN 4000870 998984  
**998.98**

**Block** A++-A  
 incl. 1x9,5 W LED  
 790 lm, 2.700 K  
 230 V  
 $\updownarrow 46 \leftrightarrow 675 \curvearrowright 95$  mm  
 EAN 4000870 998991  
**998.99**



⚙ Brushed iron 🏠 Metal  
 ⚙ Hierro mateado 🏠 Metal  
 ⚙ Ferro spazzolato 🏠 Metallo

**Galeria Remus** A++-A

incl. 1×3,5 W  
 240 lm, 3.000 K  
 230 V  
 ⌀175 ⇔395 ↗150 mm  
 EAN 4000870 990759

**990.75**

LED



On/Off

**Galeria Remus** A++-A

incl. 1×10 W  
 480 lm, 3.000 K  
 230 V  
 ⌀150 ⇔655 ↗175 mm  
 EAN 4000870 990766

**990.76**

LED



On/Off





**Galeria Double Bow**

A++-A

incl. 2×3,2W  
2×378 lm, 2.700 K  
∠ 100°  
230V  
↑105 ↔300 ↗145 mm  
EAN 4000870 993811  
**993.81 new**

LED



- ☞ Chrome ☞ Metal
- ☞ Cromo ☞ Metal
- ☞ Cromo ☞ Metallo



**Galeria Bow**

A++-A

incl. 1×3,2W  
378 lm, 2.700 K  
∠ 100°  
230V  
↑123 ↔30 ↗230 mm  
EAN 4000870 993804  
**993.80 new**

LED



- ☞ Chrome ☞ Metal
- ☞ Cromo ☞ Metal
- ☞ Cromo ☞ Metallo



**Galeria Double Hook**

A++-A

incl. 2×3,2W  
2×378 lm, 2.700 K  
∠ 100°  
230V  
↑50 ↔300 ↗110 mm  
EAN 4000870 993859  
**993.85 new**

LED



- ☞ Chrome ☞ Metal
- ☞ Cromo ☞ Metal
- ☞ Cromo ☞ Metallo



**Galeria Hook**

A++-A

incl. 1×3,2W  
378 lm, 2.700 K  
∠ 100°  
230V  
↑18 ↔150 ↗70 mm  
EAN 4000870 990896  
**990.89 new**

LED



- ☞ Chrome ☞ Metal
- ☞ Cromo ☞ Metal
- ☞ Cromo ☞ Metallo

**Galeria Frame**

A++-A

incl. 1×4,2 W  
 378 lm, 2.700 K  
 <math>\sphericalangle</math> 110°  
 230 V  
 <math>\updownarrow</math>125 <math>\leftrightarrow</math>50 <math>\curvearrowright</math>70 mm  
 EAN 4000870 990797  
**990.79 new**

LED



☞ Chrome ☞ Metal  
 ☞ Cromo ☞ Metal  
 ☞ Cromo ☞ Metallo

**Galeria Wave**

A++-A

incl. 1×3,2 W  
 378 lm, 2.700 K  
 <math>\sphericalangle</math> 100°  
 230 V  
 <math>\updownarrow</math>30 <math>\leftrightarrow</math>30 <math>\curvearrowright</math>172 mm  
 EAN 4000870 991008  
**991.00 new**

LED



☞ Chrome ☞ Metal  
 ☞ Cromo ☞ Metal  
 ☞ Cromo ☞ Metallo

**Galeria Ring**

A++-A

incl. 1×3,2 W  
 378 lm, 2.700 K  
 <math>\sphericalangle</math> 100°  
 230 V  
 <math>\updownarrow</math>30 <math>\varnothing</math>100 <math>\curvearrowright</math>110 mm  
 EAN 4000870 990865  
**990.86 new**

LED



☞ Chrome ☞ Metal  
 ☞ Cromo ☞ Metal  
 ☞ Cromo ☞ Metallo

**Galeria Oval**

A++-A

incl. 1×3,2 W  
 378 lm, 2.700 K  
 <math>\sphericalangle</math> 100°  
 230 V  
 <math>\updownarrow</math>30 <math>\leftrightarrow</math>100 <math>\curvearrowright</math>70 mm  
 EAN 4000870 990889  
**990.88 new**

LED



☞ Chrome ☞ Metal  
 ☞ Cromo ☞ Metal  
 ☞ Cromo ☞ Metallo



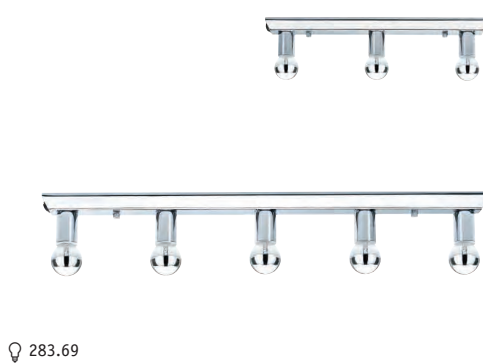

283.69

### Mirror Regula

A++-E

max. 3×40 W, E14  
230 V  
∅75 ↔420 ↗50 mm  
EAN 4000870 996799  
**996.79**



### Mirror Regula

A++-E

max. 5×40 W, E14  
230 V  
∅75 ↔650 ↗50 mm  
EAN 4000870 996805  
**996.80**



- 🔩 Chrome 📦 Metal
- 🔩 Cromo 📦 Metal
- 🔩 Cromo 📦 Metallo



### OLED Sword

A++-A

incl. 1×1,3 W  
70 lm, 2.700 K  
230 V  
∅440 ↔55 ↗32 mm  
EAN 4000870 999035  
**999.03 new**



- 🔩 Brushed aluminium/White
- 📦 Metal
- 🔩 Aluminio mateado/Blanco
- 📦 Metal
- 🔩 Alluminio spazzolato/Bianco
- 📦 Metallo



### Mirror Zylindro

A++-A

incl. 1×3 W  
120 lm, 2.700 K  
∠ 60°  
230 V, incl. ⚡3 VA  
∅260 ↔80 ↗235 mm  
EAN 4000870 990681  
**990.68**



- 🔩 Chrome 📦 Metal
- 🔩 Cromo 📦 Metal
- 🔩 Cromo 📦 Metallo



283.38



### Mirror Calami LED

A++-E

incl. 2×2,2 W, G9, <A++>  
2×200 lm, 2.700 K  
230 V  
∅60 ↔275 ↗190 mm  
EAN 4000870 998670  
**998.67 new**



- 🔩 Brushed iron 📦 Metal
- 🔩 Hierro mateado 📦 Metal
- 🔩 Ferro spazzolato 📦 Metallo

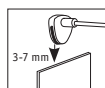

284.34  
284.10



**Mirror Simple LED**

A++-E

incl. 1x5,3 W, GU10, A++

345 lm, 2.700 K

230 V

∅60 ∅51 ↔30 ↗100 mm

EAN 4000870 999059

**999.05 new**

LED



- Brushed iron Metal
- Hierro mateado Metal
- Ferro spazzolato Metallo

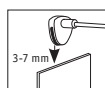

283.38  
284.46



**Mirror Vitrino LED**

A++-E

incl. 1x2,2 W, G9, A++

200 lm, 2.700 K

230 V

∅125 ∅35 ↔15 ↗100 mm

EAN 4000870 999073

**999.07 new**

LED



- Brushed iron/Opal Metal/  
Glass
- Hierro mateado/Opal Metal/  
Cristal
- Ferro spazzolato/Opale  
Metallo/Vetro

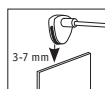

283.38  
284.46



**Mirror Curvus LED**

A++-E

incl. 1x2,2 W, G9, A++

200 lm, 2.700 K

230 V

∅230 ∅60 ↔30 ↗120 mm

EAN 4000870 999066

**999.06 new**

LED



- Brushed iron/Opal Metal/  
Glass
- Hierro mateado/Opal Metal/  
Cristal
- Ferro spazzolato/Opale  
Metallo/Vetro

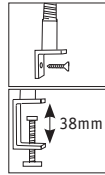

**Assistent Oculus**

A++-A

incl. 1x3 W  
6.500 K  
230/12 V  
∅300 ∅40 ∅100 mm  
EAN 4000870 996928  
**996.92**



- 🌀 Titanium 📦 Metal
- 🌀 Titanio 📦 Metal
- 🌀 Titanio 📦 Metallo

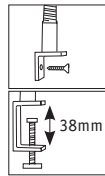

**Assistent Natrix**

A++-A

incl. 1x3 W  
4.000 K  
230/12 V  
∅300 ∅40 ∅100 mm  
EAN 4000870 996874  
**996.87**



- 🌀 Titanium 📦 Metal/Plastic
- 🌀 Titanio 📦 Metal/Plástico
- 🌀 Titanio 📦 Metallo/Plastica



**Assistent Finja LED**

A++-E

incl. 1x6,5 W, GU10, A++  
425 lm, 2.700 K  
230 V  
∅330 ∅51 ∅115 mm  
EAN 4000870 998687  
**998.68 new**



- 🌀 Chrome matt 📦 Metal/Plastic
- 🌀 Cromo mate 📦 Metal/Plástico
- 🌀 Cromo opaco 📦 Metallo/Plastica

💡 283.00  
284.10



**Assistent Gesa LED**

A++-E

incl. 1x3,5 W, GU10, A++  
230 lm, 2.700 K  
230 V  
∅282 ∅51 ∅115 mm  
EAN 4000870 999103  
**999.10 new**



- 🌀 Chrome matt 📦 Metal/Plastic
- 🌀 Cromo mate 📦 Metal/Plástico
- 🌀 Cromo opaco 📦 Metallo/Plastica

💡 282.99  
284.10



**Assistent Gryps**

A++-E

max. 40 W, E14  
230 V  
∅150 ∅60 ∅115 mm  
EAN 4000870 998250  
**998.25**



- 🌀 Brushed iron 📦 Metal/Plastic
- 🌀 Hierro mateado 📦 Metal/Plástico
- 🌀 Ferro spazzolato 📦 Metallo/Plastica

💡 282.93



### Assistent Flexus I

A++-E

max. 40W, E14  
230 V  
⌀170 ø60 ⇄60 mm  
EAN 4000870 998298  
**998.29**



- Brushed iron Metal
- Hierro mateado Metal
- Ferro spazzolato Metallo

284.60



### Assistent Flexus II

A++-E

max. 40W, E14  
230 V  
⌀170 ø60 ⇄60 mm  
EAN 4000870 998304  
**998.30**



- Brushed iron/Opal Metal/  
Glass
- Hierro mateado/Opal Metal/  
Cristal
- Ferro spazzolato/Opale  
Metallo/Vetro

284.60



### Galeria LED II

A++-E

incl. 2x4 W, GU5,3, A++  
2x230 lm, 2.700 K  
230 V, incl. 12 VA  
⌀300 ø51 ⇄25 ↗180 mm  
EAN 4000870 999080  
**999.08 new**



- Chrome Metal
- Cromo Metal
- Cromo Metallo

283.01

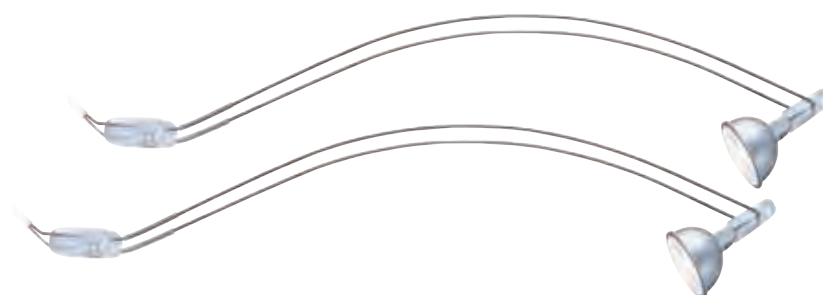

### Assistent II LED

A++-E

incl. 2x4 W, GU5,3, A++  
2x230 lm, 2.700 K  
230 V, incl. 12 VA  
⌀170 ø51 ⇄25 ↗460 mm  
EAN 4000870 999097  
**999.09 new**



- Chrome Metal
- Cromo Metal
- Cromo Metallo

283.01

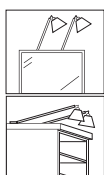

### Assistent Butler LED

A++-E

incl. 2x4 W, GU5,3, A++  
2x230 lm, 2.700 K  
incl. 12 VA  
⌀50 ø51  
⇄32 ↗170-600 mm  
EAN 4000870 999004  
**999.00 new**



- Black Metal
- Negro Metal
- Nero Metallo

283.01

# Spotlights

99 LED  
106 - 107 LED IP44



108 Turn





106 Zyli IP44







Chrome  Metal  
 Cromo  Metal  
 Cromo  Metallo

**Bowl**

A++-A

incl. 1x3,2 W  
 298 lm, 2.700 K  
 <math>\sphericalangle 95^\circ</math>  
 230 V  
 $\varnothing 90$   $\varnothing 115$  mm  
 EAN 4000870 603826  
**603.82**

**Bowl**

A++-A

incl. 2x3,2 W  
 2x298 lm, 2.700 K  
 <math>\sphericalangle 95^\circ</math>  
 230 V  
 $\varnothing 140$   $\leftrightarrow 275$   $\varnothing 198$  mm  
 EAN 4000870 603833  
**603.83**

**Bowl**

A++-A

incl. 3x3,2 W  
 3x298 lm, 2.700 K  
 <math>\sphericalangle 95^\circ</math>  
 230 V  
 $\varnothing 145$   $\leftrightarrow 485$   $\varnothing 135$  mm  
 EAN 4000870 603840  
**603.84**

**Bowl**

A++-A

incl. 4x3,2 W  
 4x298 lm, 2.700 K  
 <math>\sphericalangle 95^\circ</math>  
 230 V  
 $\varnothing 150$   $\leftrightarrow 690$   $\varnothing 135$  mm  
 EAN 4000870 603857  
**603.85**







**Bowl**

A++-A

incl. 6x3,2 W  
 6x298 lm, 2.700 K  
 <math>\sphericalangle 95^\circ</math>  
 230 V  
 $\varnothing 165$   $\leftrightarrow 1.650$   $\varnothing 135$  mm  
 EAN 4000870 603864  
**603.86**





 Brushed iron  Metal  
 Hierro mateado  Metal  
 Ferro spazzolato  Metallo



**Slice** A++-A

incl. 1×4,3 W  
 258 lm, 3.000 K  
 <math>\sphericalangle</math> 115°  
 230 V  
 $\varnothing$ 110  $\leftrightarrow$ 110  $\varnothing$ 130 mm  
 EAN 4000870 603772  
**603.77**



**Slice** A++-A

incl. 2×4,3 W  
 2×258 lm, 3.000 K  
 <math>\sphericalangle</math> 115°  
 230 V  
 $\varnothing$ 92  $\leftrightarrow$ 280  $\varnothing$ 75 mm  
 EAN 4000870 603789  
**603.78**



**Slice** A++-A

incl. 3×4,3 W  
 3×258 lm, 3.000 K  
 <math>\sphericalangle</math> 115°  
 230 V  
 $\varnothing$ 92  $\leftrightarrow$ 420  $\varnothing$ 75 mm  
 EAN 4000870 603796  
**603.79**



**Slice** A++-A

incl. 4×4,3 W  
 4×258 lm, 3.000 K  
 <math>\sphericalangle</math> 115°  
 230 V  
 $\varnothing$ 92  $\leftrightarrow$ 580  $\varnothing$ 75 mm  
 EAN 4000870 603802  
**603.80**



**Slice** A++-A

incl. 4×4,3 W  
 4×258 lm, 3.000 K  
 <math>\sphericalangle</math> 115°  
 230 V  
 $\varnothing$ 110  $\varnothing$ 450 mm  
 EAN 4000870 603819  
**603.81**





☞ Matt white/Chrome ☒ Metal/Acrylic  
 ☞ Blanco mate/Cromo ☒ Metal/Acrílico  
 ☞ Bianco opaco/Cromo ☒ Metallo/Acrilico



#### Clear A++-A

incl. 1x4,3 W  
 409 lm, 3.000 K  
 230 V  
 ⌀90 ⇄130 ↗80 mm  
 EAN 4000870 666623

**666.62 new**

#### Clear A++-A

incl. 2x4,3 W  
 2x409 lm, 3.000 K  
 230 V  
 ⌀140 ⇄305 ↗80 mm  
 EAN 4000870 666630

**666.63 new**

#### Clear A++-A

incl. 3x4,3 W  
 3x409 lm, 3.000 K  
 230 V  
 ⌀140 ⇄485 ↗80 mm  
 EAN 4000870 666647

**666.64 new**

#### Clear A++-A

incl. 4x4,3 W  
 4x409 lm, 3.000 K  
 230 V  
 ⌀150 ⇄785 ↗90 mm  
 EAN 4000870 666654

**666.65 new**



☞ Brushed aluminium/Chrome ☒ Metal/Acrylic  
 ☞ Aluminio mateado/Cromo ☒ Metal/Acrílico  
 ☞ Alluminio spazzolato/Cromo ☒ Metallo/Acrilico



#### Hemisphere A++-A

incl. 1x4,5 W  
 439 lm, 3.000 K  
 <math>\sphericalangle 120^\circ</math>  
 230 V  
 ⌀80 ⇄178 ↗130 mm  
 EAN 4000870 666302

**666.30 new**

#### Hemisphere A++-A

incl. 2x4,5 W  
 2x439 lm, 3.000 K  
 <math>\sphericalangle 120^\circ</math>  
 230 V  
 ⌀130 ⇄310 ↗80 mm  
 EAN 4000870 666319

**666.31 new**

#### Hemisphere A++-A

incl. 3x4,5 W  
 3x439 lm, 3.000 K  
 <math>\sphericalangle 120^\circ</math>  
 230 V  
 ⌀130 ⇄470 ↗80 mm  
 EAN 4000870 666326

**666.32 new**

#### Hemisphere A++-A

incl. 4x4,5 W  
 4x439 lm, 3.000 K  
 <math>\sphericalangle 120^\circ</math>  
 230 V  
 ⌀130 ⇄250 ↗250 mm  
 EAN 4000870 666333

**666.33 new**



Nickel Metal/Acrylic  
 Níquel Metal/Acrílico  
 Nichel Metallo/Acrilico



**Squarelense** A++-A  
 incl. 1×3,2 W   
 343 lm, 3.000 K   
 230 V  
 ⌀86 ⇔140 ⚙85 mm  
 EAN 4000870 666500  
**666.50 new**



**Squarelense** A++-A  
 incl. 2×3,2 W   
 2×343 lm, 3.000 K  
 230 V  
 ⌀95 ⇔230 ⚙80 mm  
 EAN 4000870 666517  
**666.51 new**



**Squarelense** A++-A  
 incl. 3×3,2 W   
 3×343 lm, 3.000 K  
 230 V  
 ⌀95 ⇔380 ⚙80 mm  
 EAN 4000870 666524  
**666.52 new**



**Squarelense** A++-A  
 incl. 4×3,2 W   
 4×343 lm, 3.000 K  
 230 V  
 ⌀95 ⇔250 ⚙250 mm  
 EAN 4000870 666531  
**666.53 new**



Chrome Metal  
 Cromo Metal  
 Cromo Metallo



**Mic** A++-A  
 incl. 1×4,5 W   
 489 lm, 3.000 K   
 < 110°  
 230 V   
 ⌀80 ⇔140 ⚙160 mm  
 EAN 4000870 666425  
**666.42 new**



**Mic** A++-A  
 incl. 2×4,5 W   
 2×489 lm, 3.000 K   
 < 110°  
 230 V  
 ⌀160 ⇔280 ⚙80 mm  
 EAN 4000870 666432  
**666.43 new**



**Mic** A++-A  
 incl. 3×4,5 W   
 3×489 lm, 3.000 K   
 < 110°  
 230 V  
 ⌀160 ⇔430 ⚙80 mm  
 EAN 4000870 666449  
**666.44 new**



**Mic** A++-A  
 incl. 4×4,5 W   
 4×489 lm, 3.000 K   
 < 110°  
 230 V  
 ⌀160 ⇔250 ⚙250 mm  
 EAN 4000870 666456  
**666.45 new**



Chrome/Clear Metal/Acrylic  
 Cromo/Transparente Metal/Acrílico  
 Cromo/Trasparente Metallo/Acricico

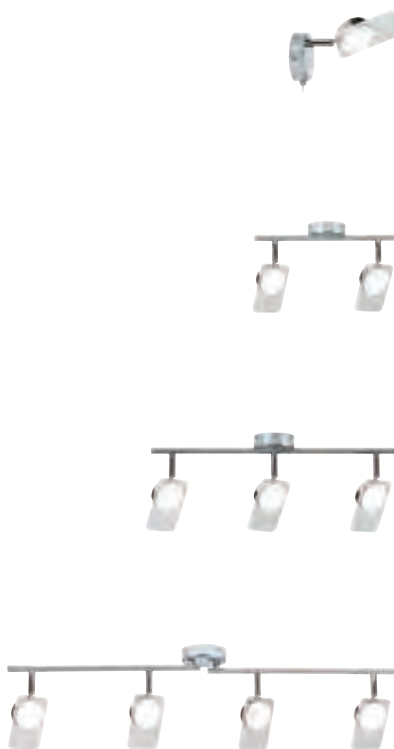

**Window** A++-A  
 incl. 1x5 W  
 381 lm, 3.000 K  
 230 V  
 ⌀130 ⇄80 ⌀80 mm  
 EAN 4000870 666661  
**666.66 new**

**Window** A++-A  
 incl. 2x5 W  
 2x381 lm, 3.000 K  
 230 V  
 ⌀90 ⇄305 ⌀80 mm  
 EAN 4000870 666678  
**666.67 new**

**Window** A++-A  
 incl. 3x5 W  
 3x381 lm, 3.000 K  
 230 V  
 ⌀90 ⇄485 ⌀80 mm  
 EAN 4000870 666685  
**666.68 new**

**Window** A++-A  
 incl. 4x5 W  
 4x381 lm, 3.000 K  
 230 V  
 ⌀100 ⇄785 ⌀90 mm  
 EAN 4000870 666692  
**666.69 new**



Matt white/Chrome Metal  
 Blanco mate/Cromo Metal  
 Bianco opaco/Cromo Metallo



**Frame** A++-A  
 incl. 1x4,5 W  
 468 lm, 3.000 K  
 <math>\sphericalangle 110^\circ</math>  
 230 V  
 ⌀140 ⇄88 ⌀131 mm  
 EAN 4000870 666388  
**666.38 new**

**Frame** A++-A  
 incl. 2x4,5 W  
 2x468 lm, 3.000 K  
 <math>\sphericalangle 110^\circ</math>  
 230 V  
 ⌀131 ⇄280 ⌀100 mm  
 EAN 4000870 666395  
**666.39 new**

**Frame** A++-A  
 incl. 3x4,5 W  
 3x468 lm, 3.000 K  
 <math>\sphericalangle 110^\circ</math>  
 230 V  
 ⌀131 ⇄430 ⌀100 mm  
 EAN 4000870 666401  
**666.40 new**

**Frame** A++-A  
 incl. 4x4,5 W  
 4x468 lm, 3.000 K  
 <math>\sphericalangle 110^\circ</math>  
 230 V  
 ⌀131 ⇄250 ⌀250 mm  
 EAN 4000870 666418  
**666.41 new**





White/Chrome Metal  
 Blanco/Cromo Metal  
 Bianco/Cromo Metallo



**Launcher** A++-A  
 incl. 1x4,5 W  
 413 lm, 3.000 K  
 <math>\sphericalangle 110^\circ</math>  
 230 V  
 $\updownarrow 140 \leftrightarrow 80 \curvearrowright 98$  mm  
 EAN 4000870 666340  
**666.34 new**



**Launcher** A++-A  
 incl. 2x4,5 W  
 2x413 lm, 3.000 K  
 <math>\sphericalangle 110^\circ</math>  
 230 V  
 $\updownarrow 98 \leftrightarrow 280 \curvearrowright 80$  mm  
 EAN 4000870 666357  
**666.35 new**



**Launcher** A++-A  
 incl. 3x4,5 W  
 3x413 lm, 3.000 K  
 <math>\sphericalangle 110^\circ</math>  
 230 V  
 $\updownarrow 98 \leftrightarrow 430 \curvearrowright 80$  mm  
 EAN 4000870 666364  
**666.36 new**



**Launcher** A++-A  
 incl. 4x4,5 W  
 4x413 lm, 3.000 K  
 <math>\sphericalangle 110^\circ</math>  
 230 V  
 $\updownarrow 98 \leftrightarrow 250 \curvearrowright 250$  mm  
 EAN 4000870 666371  
**666.37 new**



Chrome Metal/Acrylic  
 Cromo Metal/Acrylic  
 Cromo Metallo/Acrylic



**Pole** A++-A  
 incl. 1x4,2 W  
 499 lm, 3.000 K  
 230 V  
 $\updownarrow 160 \leftrightarrow 75 \curvearrowright 166$  mm  
 EAN 4000870 666548  
**666.54 new**



**Pole** A++-A  
 incl. 2x4,2 W  
 2x499 lm, 3.000 K  
 230 V  
 $\updownarrow 171 \leftrightarrow 310 \curvearrowright 75$  mm  
 EAN 4000870 666555  
**666.55 new**



**Pole** A++-A  
 incl. 3x4,2 W  
 3x499 lm, 3.000 K  
 230 V  
 $\updownarrow 171 \leftrightarrow 444 \curvearrowright 75$  mm  
 EAN 4000870 666562  
**666.56 new**



**Pole** A++-A  
 incl. 4x4,2 W  
 4x499 lm, 3.000 K  
 230 V  
 $\updownarrow 171 \leftrightarrow 282 \curvearrowright 282$  mm  
 EAN 4000870 666579  
**666.57 new**





Chrome Metal  
 Cromo Metal  
 Cromo Metallo



**Egg LED** A++-A  
 incl. 1x4,2 W  
 490 lm, 2.700 K  
 230 V  
 ⌀148 ⇔100 ↗100 mm  
 EAN 4000870 603284  
**603.28 new**

**Egg LED** A++-A  
 incl. 2x4,2 W  
 2x490 lm, 2.700 K  
 230 V  
 ⌀170 ⇔320 ↗100 mm  
 EAN 4000870 603291  
**603.29 new**

**Egg LED** A++-A  
 incl. 3x4,2 W  
 3x490 lm, 2.700 K  
 230 V  
 ⌀170 ⇔530 ↗100 mm  
 EAN 4000870 603307  
**603.30 new**

**Egg LED** A++-A  
 incl. 4x4,2 W  
 4x490 lm, 2.700 K  
 230 V  
 ⌀170 ⇔674 ↗100 mm  
 EAN 4000870 603314  
**603.31 new**



Nickel Metal  
 Niquel Metal  
 Nichel Metallo



**Tumbler** A++-A  
 incl. 1x4,5 W  
 318 lm, 3.000 K  
 230 V  
 ⌀130 ⇔152 ↗80 mm  
 EAN 4000870 666586  
**666.58 new**

**Tumbler** A++-A  
 incl. 2x4,5 W  
 2x318 lm, 3.000 K  
 230 V  
 ⌀146 ⇔303 ↗85 mm  
 EAN 4000870 666593  
**666.59 new**

**Tumbler** A++-A  
 incl. 3x4,5 W  
 3x318 lm, 3.000 K  
 230 V  
 ⌀146 ⇔505 ↗85 mm  
 EAN 4000870 666609  
**666.60 new**

**Tumbler** A++-A  
 incl. 4x4,5 W  
 4x318 lm, 3.000 K  
 230 V  
 ⌀146 ⇔731 ↗100 mm  
 EAN 4000870 666616  
**666.61 new**



Chrome Metal  
 Cromo Metal  
 Cromo Metallo

283.38  
 284.46

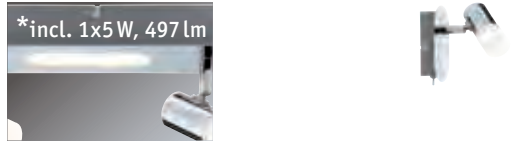

**Lagoon** A++-E  
 max. 10 W, G9  
 230 V  
 $\hat{H}$ 104  $\leftrightarrow$ 100  $\hat{L}$ 104 mm  
 EAN 4000870 666463  
**666.46 new**



**Lagoon** A++-E  
 max. 2x10 W, G9 + incl. 1x5 W  
 1x497 lm, 3.000 K  
 230 V  
 $\hat{H}$ 75  $\leftrightarrow$ 350  $\hat{L}$ 150 mm  
 EAN 4000870 666470  
**666.47 new**

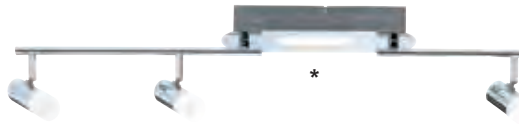

**Lagoon** A++-E  
 max. 3x10 W, G9 + incl. 1x5 W  
 1x497 lm, 3.000 K  
 230 V  
 $\hat{H}$ 75  $\leftrightarrow$ 845  $\hat{L}$ 155 mm  
 EAN 4000870 666494  
**666.49 new**



**Lagoon** A++-E  
 max. 4x10 W, G9 + incl. 1x5 W  
 1x497 lm, 3.000 K  
 230 V  
 $\hat{H}$ 115  $\hat{D}$ 290 mm  
 EAN 4000870 666487  
**666.48 new**



White/Chrome Metal  
 Blanco/Cromo Metal  
 Bianco/Cromo Metallo

282.99  
 283.00



**Zyli IP44** A++-E  
 max. 10 W, GU10  
 230 V  
 $\hat{D}$ 100  $\hat{L}$ 110 mm  
 EAN 4000870 667101  
**667.10 new**



**Zyli IP44** A++-E  
 max. 2x10 W, GU10  
 230 V  
 $\hat{H}$ 110  $\leftrightarrow$ 400  $\hat{L}$ 70 mm  
 EAN 4000870 667118  
**667.11 new**



**Zyli IP44** A++-E  
 max. 3x10 W, GU10  
 230 V  
 $\hat{H}$ 110  $\leftrightarrow$ 600  $\hat{L}$ 70 mm  
 EAN 4000870 667132  
**667.13 new**



**Zyli IP44** A++-E  
 max. 3x10 W, GU10  
 230 V  
 $\hat{H}$ 110  $\hat{D}$ 250 mm  
 EAN 4000870 667125  
**667.12 new**



⚙ White/Chrome 📏 Metal  
 ⚙ Blanco/Cromo 📏 Metal  
 ⚙ Bianco/Cromo 📏 Metallo

💡 282.99  
 283.00

**Drop IP44**

A++-E

max. 10 W, GU10  
 230 V  
 ⚙ 123 ⌀100 ↗165 mm  
 EAN 4000870 667149  
**667.14 new**

**Drop IP44**

A++-E

max. 2×10 W, GU10  
 230 V  
 ⚙ 165 ↔350 ↗65 mm  
 EAN 4000870 667156  
**667.15 new**

**Drop IP44**

A++-E

max. 3×10 W, GU10  
 230 V  
 ⚙ 165 ⌀250 mm  
 EAN 4000870 667163  
**667.16 new**



⚙ White/Chrome 📏 Metal  
 ⚙ Blanco/Cromo 📏 Metal  
 ⚙ Bianco/Cromo 📏 Metallo

💡 282.99  
 283.00

**Tube IP44**

A++-E

max. 10 W, GU10  
 230 V  
 ⚙ 138 ⌀100 ↗94 mm  
 EAN 4000870 667170  
**667.17 new**

**Tube IP44**

A++-E

max. 2×10 W, GU10  
 230 V  
 ⚙ 94 ↔350 ↗65 mm  
 EAN 4000870 667187  
**667.18 new**

**Tube IP44**

A++-E

max. 3×10 W, GU10  
 230 V  
 ⚙ 94 ⌀250 mm  
 EAN 4000870 667194  
**667.19 new**





☞ White/Chrome ☒ Metal/Plastic  
 ☞ Blanco/Cromo ☒ Metal/Plástico  
 ☞ Bianco/Cromo ☒ Metallo/Plastica

⚡ 283.00  
 284.34  
 500.14  
 500.15  
 500.21



**Turn** A++-E  
 max. 10 W, GU10  
 230 V  
 ⚡140 ⇄98 ⚡150 mm  
 EAN 4000870 666746  
**666.74 new**

**Turn** A++-E  
 max. 2×10 W, GU10  
 230 V  
 ⚡140 ⇄400 ⚡98 mm  
 EAN 4000870 666753  
**666.75 new**

**Turn** A++-E  
 max. 4×10 W, GU10  
 230 V  
 ⚡140 ⇄680 ⚡98 mm  
 EAN 4000870 666760  
**666.76 new**



☞ Black/Chrome ☒ Metal/Plastic  
 ☞ Negro/Cromo ☒ Metal/Plástico  
 ☞ Nero/Cromo ☒ Metallo/Plastica

⚡ 283.00  
 284.34  
 500.14  
 500.15  
 500.21



**Turn** A++-E  
 max. 10 W, GU10  
 230 V  
 ⚡140 ⇄98 ⚡150 mm  
 EAN 4000870 666708  
**666.70 new**

**Turn** A++-E  
 max. 2×10 W, GU10  
 230 V  
 ⚡140 ⇄400 ⚡98 mm  
 EAN 4000870 666715  
**666.71 new**

**Turn** A++-E  
 max. 4×10 W, GU10  
 230 V  
 ⚡140 ⇄680 ⚡98 mm  
 EAN 4000870 666722  
**666.72 new**





☞ Chrome matt/Opal ☒ Metal/Glass  
 ☞ Cromo mate/Opal ☒ Metal/Cristal  
 ☞ Cromo opaco/Opale ☒ Metallo/Vetro

⚡ 282.86  
 284.34



#### WolbaLED A++-E

max. 10 W, GU10  
 230 V  
 ⚡105 ⇄100 ⚡105 mm  
 EAN 4000870 666821

**666.82 new**



#### WolbaLED A++-E

max. 2×10 W, GU10  
 230 V  
 ⚡105 ⇄275 ⚡60 mm  
 EAN 4000870 666838

**666.83 new**



#### WolbaLED A++-E

max. 4×10 W, GU10  
 230 V  
 ⚡105 ⇄210 ⚡210 mm  
 EAN 4000870 666845

**666.84 new**



#### WolbaLED A++-E

max. 6×10 W, GU10  
 230 V  
 ⚡170 ⇄1.660 ⚡55 mm  
 EAN 4000870 666852

**666.85 new**



☞ Chrome/Satin ☒ Metal/Glass  
 ☞ Cromo/Satinado ☒ Metal/Cristal  
 ☞ Cromo/Satinato ☒ Metallo/Vetro

⚡ 284.46



#### Yasmin A++-E

max. 10 W, G9  
 230 V  
 ø80 ⚡155 mm  
 EAN 4000870 666906

**666.90 new**



#### Yasmin A++-E

max. 3×10 W, G9  
 230 V  
 ⚡140 ø280 mm  
 EAN 4000870 666913

**666.91 new**



#### Yasmin A++-E

max. 4×10 W, G9  
 230 V  
 ⚡145 ⇄715 ⚡100 mm  
 EAN 4000870 666920

**666.92 new**





Chrome Metal  
 Cromo Metal  
 Cromo Metallo

283.00  
 284.34  
 500.14  
 500.15  
 500.21



**Rondo**   
 max. 10 W, GU10  
 230 V  
 ⌀105 ⇄100 ⌀120 mm  
 EAN 4000870 666784  
**666.78 new**

**Rondo**   
 max. 2×10 W, GU10  
 230 V  
 ⌀120 ⇄260 ⌀75 mm  
 EAN 4000870 666791  
**666.79 new**

**Rondo**   
 max. 3×10 W, GU10  
 230 V  
 ⌀120 ⇄420 ⌀75 mm  
 EAN 4000870 666807  
**666.80 new**

**Rondo**   
 max. 4×10 W, GU10  
 230 V  
 ⌀120 ⌀220 mm  
 EAN 4000870 666814  
**666.81 new**



Satin nickel Metal  
 Níquel satinado Metal  
 Nichel satinato Metallo

283.00  
 284.34  
 500.14  
 500.15  
 500.21



**Meli**   
 max. 10 W, GU10  
 230 V  
 ⌀100 ⇄100 ⌀160 mm  
 EAN 4000870 666869  
**666.86 new**

**Meli**   
 max. 2×10 W, GU10  
 230 V  
 ⌀160 ⇄260 ⌀55 mm  
 EAN 4000870 666876  
**666.87 new**

**Meli**   
 max. 3×10 W, GU10  
 230 V  
 ⌀160 ⇄400 ⌀55 mm  
 EAN 4000870 666883  
**666.88 new**

**Meli**   
 max. 4×10 W, GU10  
 230 V  
 ⌀160 ⇄600 ⌀55 mm  
 EAN 4000870 666890  
**666.89 new**



Chrome Metal  
 Cromo Metal  
 Cromo Metallo

283.00  
 284.34  
 500.14  
 500.15  
 500.21

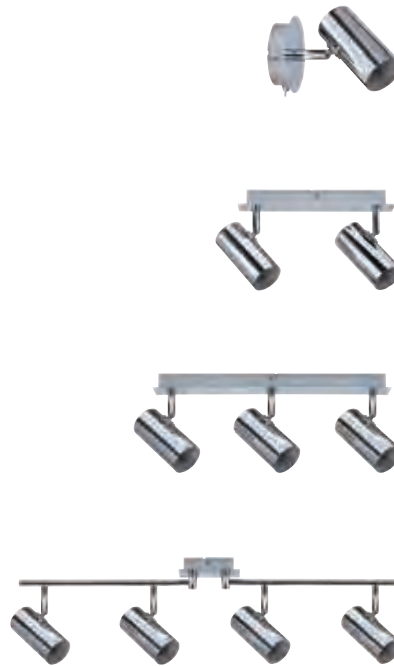

**Zyllo** A++-E  
 max. 10 W, GU10  
 230 V  
 100 ⇄ 100 132 mm  
 EAN 4000870 666937  
**666.93 new**

**Zyllo** A++-E  
 max. 2×10 W, GU10  
 230 V  
 132 ⇄ 260 55 mm  
 EAN 4000870 666944  
**666.94 new**

**Zyllo** A++-E  
 max. 3×10 W, GU10  
 230 V  
 132 ⇄ 400 55 mm  
 EAN 4000870 666951  
**666.95 new**

**Zyllo** A++-E  
 max. 4×10 W, GU10  
 230 V  
 132 ⇄ 695 70 mm  
 EAN 4000870 666968  
**666.96 new**



Brushed nickel Metal  
 Níquel mateado Metal  
 Nichel spazzolato Metallo

284.10  
 284.34  
 500.14  
 500.15  
 500.21

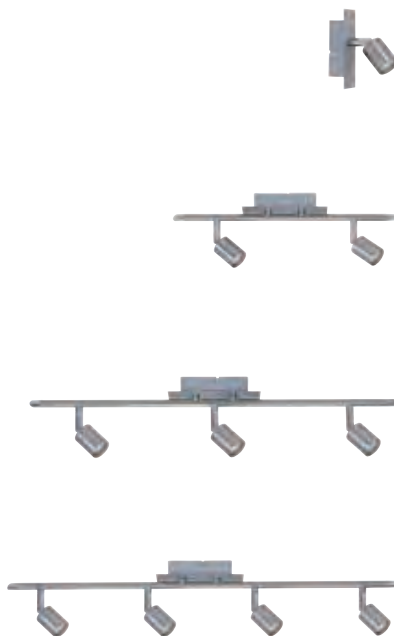

**Georgia** A++-E  
 max. 10 W, GU10  
 230 V  
 125 ⇄ 55 75 mm  
 EAN 4000870 667064  
**667.06 new**

**Georgia** A++-E  
 max. 2×10 W, GU10  
 230 V  
 100 ⇄ 396 55 mm  
 EAN 4000870 667071  
**667.07 new**

**Georgia** A++-E  
 max. 3×10 W, GU10  
 230 V  
 100 ⇄ 600 55 mm  
 EAN 4000870 667088  
**667.08 new**

**Georgia** A++-E  
 max. 4×10 W, GU10  
 230 V  
 100 ⇄ 675 55 mm  
 EAN 4000870 667095  
**667.09 new**



Satin nickel Metal  
 Níquel satinado Metal  
 Nichel satinato Metallo

284.10  
 284.34  
 500.14  
 500.15  
 500.21



**Teja**   
 max. 10 W, GU10  
 230 V  
 ⌀100 ⇄52 ⌀120 mm  
 EAN 4000870 666982  
**666.98 new**



**Teja**   
 max. 2×10 W, GU10  
 230 V  
 ⌀120 ⇄308 ⌀52 mm  
 EAN 4000870 666999  
**666.99 new**



**Teja**   
 max. 3×10 W, GU10  
 230 V  
 ⌀120 ⇄500 ⌀52 mm  
 EAN 4000870 667002  
**667.00 new**



**Teja**   
 max. 4×10 W, GU10  
 230 V  
 ⌀120 ⇄250 ⌀250 mm  
 EAN 4000870 667019  
**667.01 new**



**Teja Flex**   
 max. 10 W, GU10  
 230 V  
 ⌀100 ⇄52 ⌀350 mm  
 EAN 4000870 666975  
**666.97 new**



White Metal  
 Blanco Metal  
 Bianco Metallo

284.10  
 284.34  
 500.14  
 500.15  
 500.21



**Teja**   
 max. 10 W, GU10  
 230 V  
 ⌀100 ⇄52 ⌀120 mm  
 EAN 4000870 667026  
**667.02 new**



**Teja**   
 max. 2×10 W, GU10  
 230 V  
 ⌀120 ⇄308 ⌀52 mm  
 EAN 4000870 667033  
**667.03 new**



**Teja**   
 max. 3×10 W, GU10  
 230 V  
 ⌀120 ⇄500 ⌀52 mm  
 EAN 4000870 667040  
**667.04 new**



**Teja**   
 max. 4×10 W, GU10  
 230 V  
 ⌀120 ⇄250 ⌀250 mm  
 EAN 4000870 667057  
**667.05 new**



⚙️ Brushed nickel Metal/Glass  
 ⚙️ Níquel mateado Metal/Cristal  
 ⚙️ Nichel spazzolato Metallo/Vetro

💡 283.38



**Helix** A++-E  
 incl. 1×2,2 W, G9, A+  
 200 lm, 2.700 K  
 230 V  
 ⚙️ 127 ⚡ 90 ⚡ 110 mm  
 EAN 4000870 601983  
**601.98**

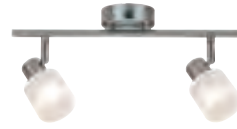

**Helix** A++-E  
 incl. 2×2,2 W, G9, A+  
 2×200 lm, 2.700 K  
 230 V  
 ⚙️ 130 ⚡ 365 ⚡ 90 mm  
 EAN 4000870 601990  
**601.99**



**Helix** A++-E  
 incl. 3×2,2 W, G9, A+  
 3×200 lm, 2.700 K  
 230 V  
 ⚙️ 135 ⚡ 525 ⚡ 90 mm  
 EAN 4000870 602003  
**602.00**



**Helix** A++-E  
 incl. 4×2,2 W, G9, A+  
 4×200 lm, 2.700 K  
 230 V  
 ⚙️ 120 ⚡ 220 mm  
 EAN 4000870 601624  
**601.62**



⚙️ White/Chrome Metal  
 ⚙️ Blanco/Cromo Metal  
 ⚙️ Bianco/Cromo Metallo

💡 283.38  
 284.46



**LED Double** A++-E  
 incl. 1×2,2 W, G9, A+  
 200 lm, 2.700 K  
 230 V  
 ⚙️ 108 ⚡ 100 ⚡ 100 mm  
 EAN 4000870 666180  
**666.18 new**



**LED Double** A++-E  
 incl. 2×2,2 W, G9, A+  
 2×200 lm, 2.700 K  
 230 V  
 ⚙️ 118 ⚡ 364 ⚡ 100 mm  
 EAN 4000870 666197  
**666.19 new**



**LED Double** A++-E  
 incl. 3×2,2 W, G9, A+  
 3×200 lm, 2.700 K  
 230 V  
 ⚙️ 118 ⚡ 604 ⚡ 100 mm  
 EAN 4000870 666203  
**666.20 new**



**LED Double** A++-E  
 incl. 4×2,2 W, G9, A+  
 4×200 lm, 2.700 K  
 230 V  
 ⚙️ 118 ⚡ 704 ⚡ 100 mm  
 EAN 4000870 666210  
**666.21 new**





# Wire Systems

116 LED DC

119 LED AC



116 RoundMac



116 QuadLED

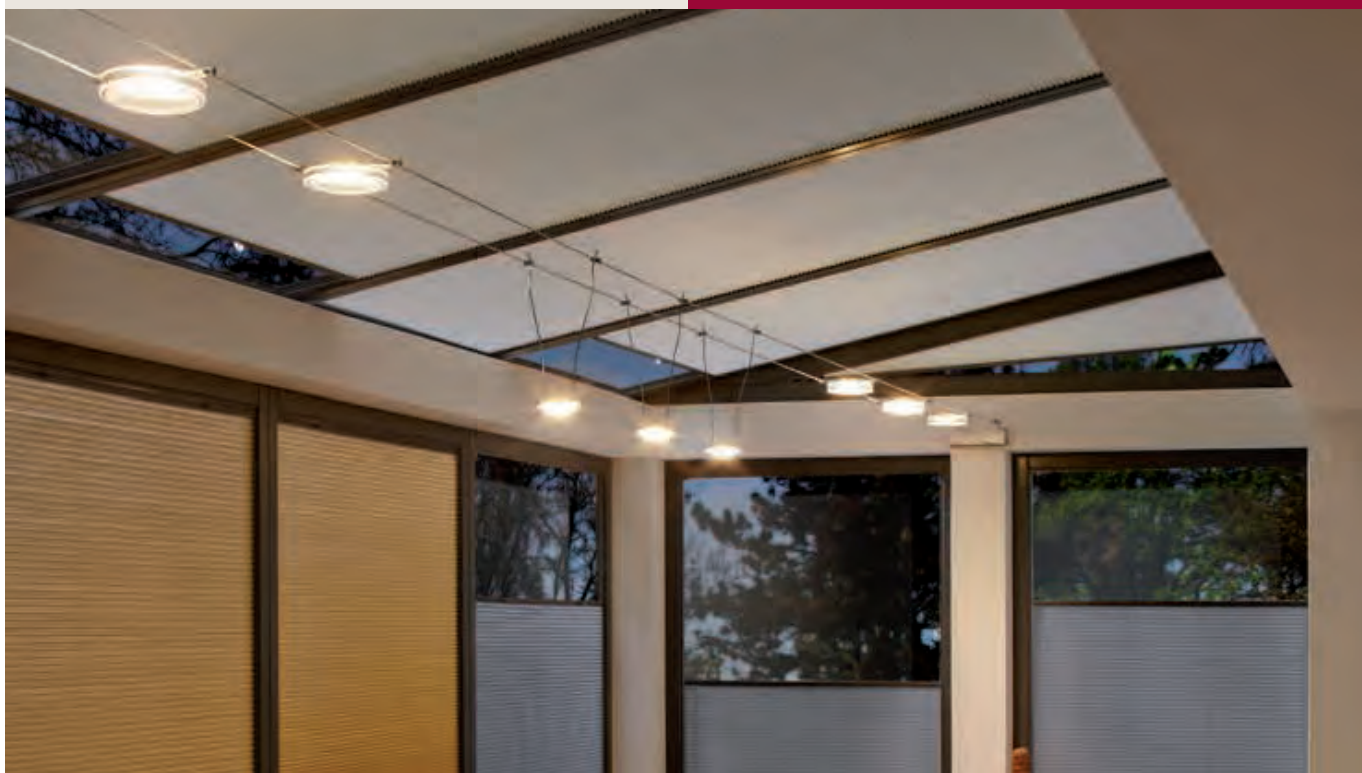

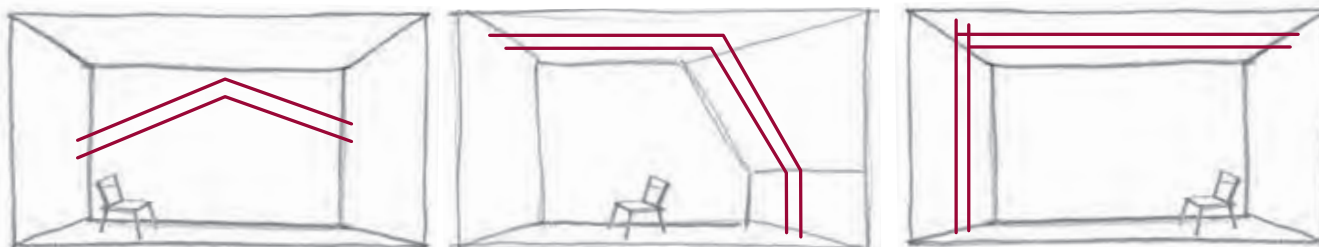

Cable systems are a flexible solution for making your own four walls appear in the right light. Installing the live cables is simple and, thanks to modern 12 V technology, safer and much simpler than conventional 230 V installations. Even in difficult spaces (e.g. slanted ceilings or around corners), cable systems are the ideal lighting solution. By using deflectors (sold separately), entire living areas can be completely illuminated using just one installation. With more than 30 different complete sets to choose from you are sure to find something to suit your taste. The wide variety of luminaires provides the right solution for every need: Everything from directed light for individual object illumination to soft light distribution for uniform basic lighting is possible.

Los sistemas de cables son una solución flexible para poner en escena la vivienda. El tendido de los cables eléctricos no presenta ningún problema; gracias a la moderna tecnología de 12 V, es más seguro y mucho más sencillo que en las instalaciones convencionales de 230 V. Incluso en situaciones de espacio difíciles (p. ej., techos inclinados o conexiones en ángulo), los sistemas de cables ofrecen soluciones de luz óptimas. El uso de deflectores (disponibles por separado) también permite iluminar de forma extensa zonas completas de la vivienda con una única instalación. Los más de 30 juegos completos se adaptan a todos los gustos en la decoración. La variedad de luminarias disponibles ofrece la solución adecuada para todas las necesidades: permiten crear tanto una luz dirigida para la iluminación individual de objetos como una distribución lumínica suave para una iluminación de fondo uniforme.

I sistemi a filo sono una soluzione flessibile per dare la giusta illuminazione alla propria casa. La posa dei fili elettrici non presenta alcun problema e grazie alla moderna tecnologia a 12V è più sicura e semplice rispetto alla normali installazioni da 230V. I sistemi a filo forniscono soluzioni luce ideali anche in situazioni difficili (ad es. soffitti inclinati o collegamenti angolari). Utilizzando deviatori (disponibili come optional) si possono illuminare perfettamente interi spazi abitativi con una sola installazione. Più di 30 set completi soddisfano ogni gusto abitativo. La varietà di lampade disponibili offre la giusta soluzione per ogni tipo di esigenza: si può ottenere una luce direzionata per l'illuminazione personalizzata di oggetti ma anche una delicata distribuzione della luce per un'illuminazione di base e uniforme.



230V Trafo **12V** DC



**Set RoundMac**

incl. 6x4 W  
6x200 lm, 2.700 K  
230/12V, incl. 30 VA  
 160 mm 2,5 mm<sup>2</sup> 10 m  
EAN 4000870 941065  
**941.06**

**Set RoundMac**

incl. 4x4 W  
4x200 lm, 2.700 K  
230/12V, incl. 36 VA  
 160 mm 2,5 mm<sup>2</sup> 10 m  
EAN 4000870 941058  
**941.05**

**Spot RoundMac**

incl. 1x4 W  
200 lm, 2.700 K  
12 V  
 160 24 102 mm  
EAN 4000870 940884  
**940.88**

- Matt white Metal/Plastic
- Blanco mate Metal/Plástico
- Bianco opaco Metallo/Plastica



230V Trafo **12V** DC

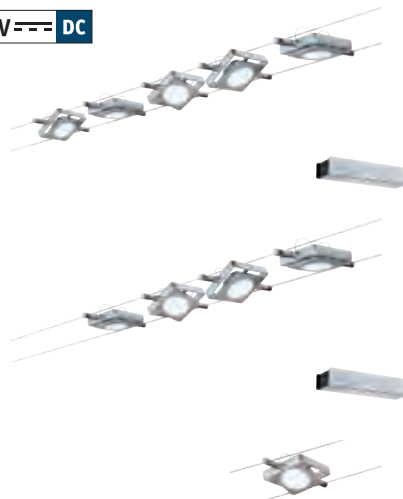

**Set MacLED**

incl. 5x4 W  
5x200 lm, 2.700 K  
230/12V, incl. 30 VA  
 160 mm 2,5 mm<sup>2</sup> 10 m  
EAN 4000870 941089  
**941.08**

**Set MacLED**

incl. 4x4 W  
4x200 lm, 2.700 K  
230/12V, incl. 36 VA  
 160 mm 2,5 mm<sup>2</sup> 10 m  
EAN 4000870 941072  
**941.07**

**Spot MacLED**

incl. 1x4 W  
200 lm, 2.700 K  
12 V  
 160 24 92 92 mm  
EAN 4000870 940891  
**940.89**

- Chrome matt Metal/Plastic
- Cromo mate Metal/Plástico
- Cromo opaco Metallo/Plastica



230V Trafo **12V** DC

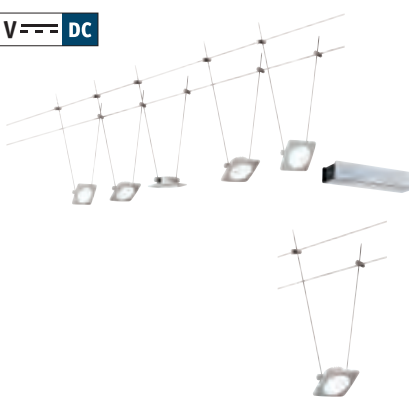

**Set QuadLED**

incl. 5x4 W  
5x200 lm, 2.700 K  
230/12V, incl. 30 VA  
 160 mm 2,5 mm<sup>2</sup> 10 m  
EAN 4000870 941119  
**941.11**

**Spot QuadLED**

incl. 1x4 W  
200 lm, 2.700 K  
12 V  
 160 24 72 72 mm  
EAN 4000870 940914  
**940.91**

- Chrome matt Metal/Plastic
- Cromo mate Metal/Plástico
- Cromo opaco Metallo/Plastica



Chrome matt/Transparent Metal/Plastic  
 Cromo mate/Transparente Metal/  
 Plástico  
 Cromo opaco/Trasparente Metallo/  
 Plastica

230V Trafo 12V DC



#### Set LED Twist Coin

A++-A

incl. 6×4 W  
 6×200 lm, 2.700 K  
 230/12 V, incl. 30 VA  
 160 mm 2,5 mm<sup>2</sup> ⇔ 10 m  
 EAN 4000870 941171

LED



941.17



#### Set LED Twist Coin

A++-A

incl. 4×4 W  
 4×200 lm, 2.700 K  
 230/12 V, incl. 30 VA  
 160 mm 2,5 mm<sup>2</sup> ⇔ 10 m  
 EAN 4000870 941164

LED



941.16



#### Spot Twist Coin

A++-A

incl. 1×4 W  
 200 lm, 2.700 K  
 12 V  
 160 ⇔ 24 ∅ 82 mm  
 EAN 4000870 940945

LED



940.94



Chrome matt/White Metal/Plastic  
 Cromo mate/Blanco Metal/Plástico  
 Cromo opaco/Bianco Metallo/Plastica

230V Trafo 12V DC

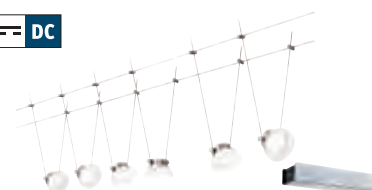

#### Set IceLED I

A++-A

incl. 6×4 W  
 6×200 lm, 2.700 K  
 230/12 V, incl. 30 VA  
 160 mm 2,5 mm<sup>2</sup> ⇔ 10 m  
 EAN 4000870 941133

LED



941.13

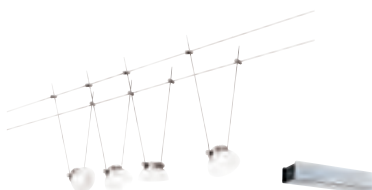

#### Set IceLED I

A++-A

incl. 4×4 W  
 4×200 lm, 2.700 K  
 230/12 V, incl. 30 VA  
 160 mm 2,5 mm<sup>2</sup> ⇔ 10 m  
 EAN 4000870 941126

LED



941.12



#### Spot IceLED I

A++-A

incl. 1×4 W  
 200 lm, 2.700 K  
 12 V  
 160 ⇔ 46 ∅ 80 mm  
 EAN 4000870 940921

LED



940.92



Chrome matt/Matt white Metal/Plastic  
 Cromo mate/Blanco mate Metal/Plástico  
 Cromo opaco/Bianco opaco Metallo/  
 Plastica

230V Trafo 12V DC

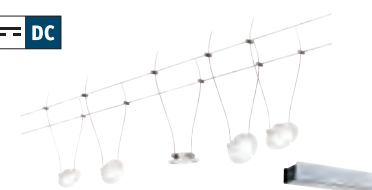

#### Set DaisyLED

A++-A

incl. 5×4 W  
 5×200 lm, 2.700 K  
 230/12 V, incl. 30 VA  
 160 mm 2,5 mm<sup>2</sup> ⇔ 10 m  
 EAN 4000870 941188

LED



941.18



#### Spot DaisyLED

A++-A

incl. 1×4 W  
 200 lm, 2.700 K  
 12 V  
 160 ⇔ 24 ∅ 82 mm  
 EAN 4000870 940952

LED



940.95





230V Trafo **12V** **DC**



**Set IceLED II**   
 incl. 6x4 W  
 6x200 lm, 2.700 K  
 230/12 V, incl. 30 VA  
 160 mm 2,5 mm<sup>2</sup> ⇔ 10 m  
 EAN 4000870 941157  
**941.15**



**Set IceLED II**   
 incl. 4x4 W  
 4x200 lm, 2.700 K  
 230/12 V, incl. 30 VA  
 160 mm 2,5 mm<sup>2</sup> ⇔ 10 m  
 EAN 4000870 941140  
**941.14**



**Spot IceLED II**   
 incl. 1x4 W  
 200 lm, 2.700 K  
 12 V  
 160 46 75 mm  
 EAN 4000870 940938  
**940.93**

Chrome matt/White Metal/Plastic  
 Cromo mate/Blanco Metal/Plástico  
 Cromo opaco/Bianco Metallo/Plastica



230V Trafo **12V** **DC**



**Set DiscLED I**   
 incl. 5x4 W  
 5x200 lm, 2.700 K  
 230/12 V, incl. 36 VA  
 160 mm 2,5 mm<sup>2</sup> ⇔ 10 m  
 EAN 4000870 941096  
**941.09**



**Spot DiscLED I**   
 incl. 1x4 W  
 200 lm, 2.700 K  
 12 V  
 160 37 130 mm  
 EAN 4000870 940907  
**940.90**

Chrome/Satin Metal/Plastic  
 Cromo/Satinado Metal/Plástico  
 Cromo/Satinato Metallo/Plastica



230V Trafo **12V** **DC**



**Set DiscLED II**   
 incl. 5x4 W  
 5x250 lm, 2.700 K  
 230/12 V, incl. 30 VA  
 160 mm 2,5 mm<sup>2</sup> ⇔ 10 m  
 EAN 4000870 941102  
**941.10**

Chrome Metal/Plastic  
 Cromo Metal/Plástico  
 Cromo Metallo/Plastica





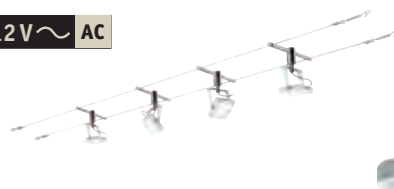

230V  **12V ~ AC**

**Set Meta**

A++-A

incl. 4×5 W  
 4×350 lm, 2.700 K  
 230/12 V, incl.  30 VA  
 160 mm 2,5 mm<sup>2</sup> ⇔ 10 m  
 EAN 4000870 940792  
**940.79**

LED





 White/Chrome  Metal/Glass  
 Blanco/Cromo  Metal/Cristal  
 Bianco/Cromo  Metallo/Vetro



230V  **12V ~ AC**

**Set Stage**

A++-A

incl. 4×5 W  
 4×300 lm, 2.700 K  
 230/12 V, incl.  30 VA  
 160 mm 2,5 mm<sup>2</sup> ⇔ 10 m  
 EAN 4000870 940808  
**940.80**

LED





 White/Chrome  Metal/Glass  
 Blanco/Cromo  Metal/Cristal  
 Bianco/Cromo  Metallo/Vetro

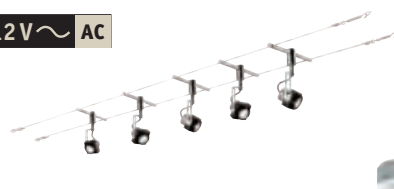

230V  **12V ~ AC**







**Set Phase**

A++-A

incl. 5×5 W  
 5×350 lm, 2.700 K  
 230/12 V, incl.  36 VA  
 160 mm 2,5 mm<sup>2</sup> ⇔ 10 m  
 EAN 4000870 940815  
**940.81**

LED





 Black/Chrome  Metal  
 Negro/Cromo  Metal  
 Nero/Cromo  Metallo



230V  **12V ~ AC**







**Set Mezzo**

A++-A

incl. 5×5 W  
 5×450 lm, 2.700 K  
 < 30°  
 230/12 V, incl.  36 VA  
 160 mm 2,5 mm<sup>2</sup> ⇔ 10 m  
 EAN 4000870 940822  
**940.82**

LED



 White  Metal  
 Blanco  Metal  
 Bianco  Metallo





230V 

12V ~ AC









**Set TogoLED**

A++-E

incl. 4x4 W, GU5,3,   
 4x230 lm, 2.700 K  
 230/12V, incl.  80 VA  
 160 mm 2,5 mm<sup>2</sup> ⇔ 10 m  
 EAN 4000870 941201  
**941.20**



-  Chrome  Metal
-  Cromo  Metal
-  Cromo  Metallo

 283.01





230V 

12V ~ AC









**Set Spice SaltLED**

A++-E

incl. 5x4 W, GU5,3,   
 5x230 lm, 2.700 K  
 230/12V, incl.  80 VA  
 160 mm 2,5 mm<sup>2</sup> ⇔ 10 m  
 EAN 4000870 941249  
**941.24**



-  Chrome matt  Metal
-  Cromo mate  Metal
-  Cromo opaco  Metallo

 283.01



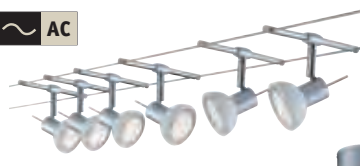

230V 

12V ~ AC









**Set SheelaLED**

A++-E

incl. 6x4 W, GU5,3,   
 6x230 lm, 2.700 K  
 230/12V, incl.  80 VA  
 160 mm 2,5 mm<sup>2</sup> ⇔ 10 m  
 EAN 4000870 941232  
**941.23**



-  Chrome matt/Opal  Metal/Glass
-  Cromo mate/Opal  Metal/Cristal
-  Cromo opaco/Opale  Metallo/Vetro

 283.01



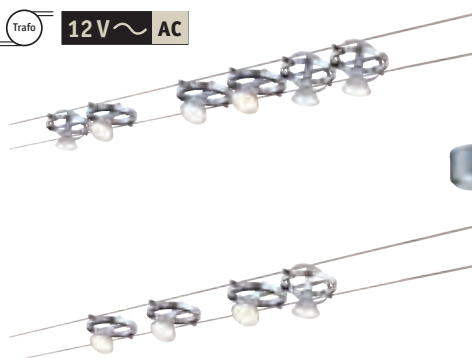

230V  12V ~ AC



#### Set Cardan LED



A++-E

incl. 6×4 W, GU5,3,   
 6×230 lm, 2.700 K  
 230/12 V, incl.  80 VA  
 125 mm 4 mm<sup>2</sup> ⇔ 12 m  
 EAN 4000870 941270  
**941.27**









#### Set Cardan LED

A++-E

incl. 4×4 W, GU5,3,   
 4×230 lm, 2.700 K  
 230/12 V, incl.  80 VA  
 125 mm 2,5 mm<sup>2</sup> ⇔ 10 m  
 EAN 4000870 941256  
**941.25**



-  Chrome/Chrome matt  Metal
-  Cromo/Cromo mate  Metal
-  Cromo/Cromo opaco  Metallo

 283.01



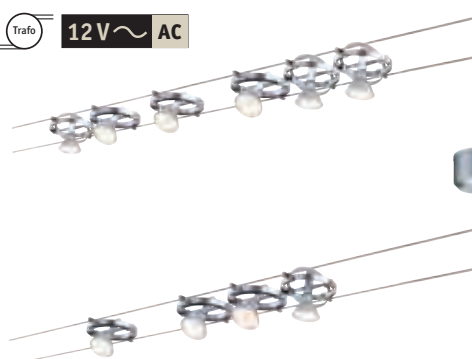

230V  12V ~ AC



#### Set Cardan LED



A++-E

incl. 6×4 W, GU5,3,   
 6×230 lm, 2.700 K  
 230/12 V, incl.  80 VA  
 125 mm 4 mm<sup>2</sup> ⇔ 12 m  
 EAN 4000870 941287  
**941.28**









#### Set Cardan LED

A++-E

incl. 4×4 W, GU5,3,   
 4×230 lm, 2.700 K  
 230/12 V, incl.  80 VA  
 125 mm 2,5 mm<sup>2</sup> ⇔ 10 m  
 EAN 4000870 941263  
**941.26**



-  Chrome/White  Metal
-  Cromo/Blanco  Metal
-  Cromo/Bianco  Metallo

 283.01



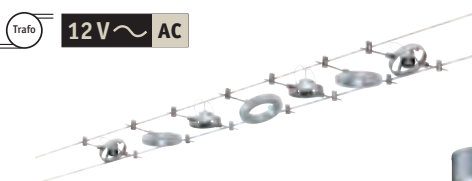

230V  12V ~ AC







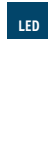

#### Set HaloLED

A++-A A++-E

max. 4×10 W, GU4/  
 incl. 3×1,5 W  
 230/12 V, incl.  80 VA  
 160 mm 2,5 mm<sup>2</sup> ⇔ 12 m  
 EAN 4000870 941423  
**941.42 new**



-  Chrome matt  Metal
-  Cromo mate  Metal
-  Cromo opaco  Metallo

 282.60



230V  **12V ~ AC**

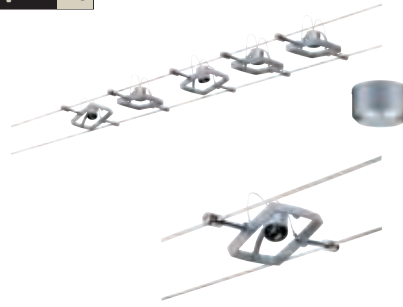







**Set Mac II** A++-E

max. 5×10 W, GU5,3  
 230/12 V, incl.  60 VA  
 ⚙️ 160 mm 2,5 mm<sup>2</sup> ↔ 10 m  
 EAN 4000870 941331  
**941.33 new**

**Spot Mac II** A++-E

max. 10 W, GU5,3   
 12 V  
 ⚙️ 160 ⚡ 55 ↔ 70 ↗ 70 mm  
 EAN 4000870 941324  
**941.32 new**



-  Chrome matt  Metal/Plastic
-  Cromo mate  Metal/Plástico
-  Cromo opaco  Metallo/Plastica

 283.47





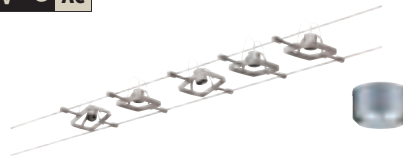



230V  **12V ~ AC**



**Set Mac II** A++-E

max. 5×10 W, GU5,3  
 230/12 V, incl.  60 VA  
 ⚙️ 160 mm 2,5 mm<sup>2</sup> ↔ 10 m  
 EAN 4000870 941355  
**941.35 new**

-  Satin nickel  Metal
-  Níquel satinado  Metal
-  Nichel satinato  Metallo

 283.47





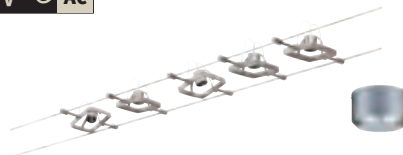



230V  **12V ~ AC**



**Set Mac II** A++-E

max. 5×10 W, GU5,3  
 230/12 V, incl.  60 VA  
 ⚙️ 160 mm 2,5 mm<sup>2</sup> ↔ 10 m  
 EAN 4000870 941348  
**941.34 new**

-  White  Metal
-  Blanco  Metal
-  Bianco  Metallo

 283.47



Chrome matt/Chrome Metal  
 Cromo mate/Cromo Metal  
 Cromo opaco/Cromo Metallo

283.47

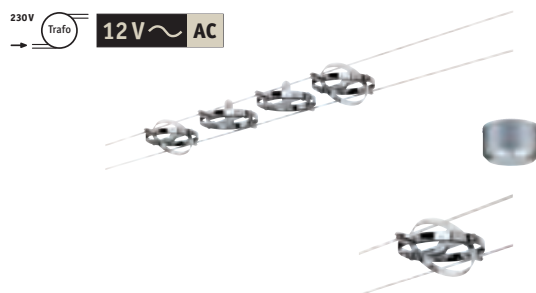

#### Set Cardan A++-E

max. 4×10 W, GU5,3  
 230/12 V, incl. 80 VA  
 125 mm 2,5 mm<sup>2</sup> ⇔ 10 m  
 EAN 4000870 941447  
**941.44 new**

#### Spot Cardan A++-E

max. 10 W, GU5,3  
 12 V  
 125 ⇕ 100 ø110 mm  
 EAN 4000870 941379  
**941.37 new**



Chrome Metal  
 Cromo Metal  
 Cromo Metallo

283.30

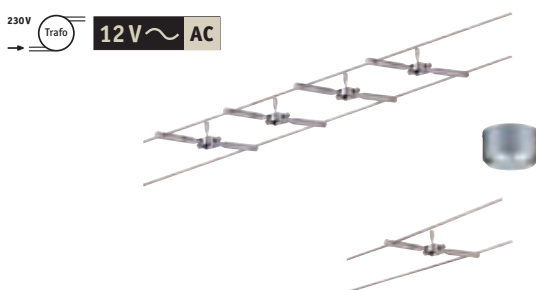

#### Set Togo A++-E

max. 4×10 W, GU5,3  
 230/12 V, incl. 80 VA  
 160 mm 4 mm<sup>2</sup> ⇔ 10 m  
 EAN 4000870 941461  
**941.46 new**

#### Spot Togo A++-E

max. 10 W, GU5,3  
 12 V  
 160 ⇕ 80 ø51 mm  
 EAN 4000870 941478  
**941.47 new**



Chrome matt Metal  
 Cromo mate Metal  
 Cromo opaco Metallo

283.47

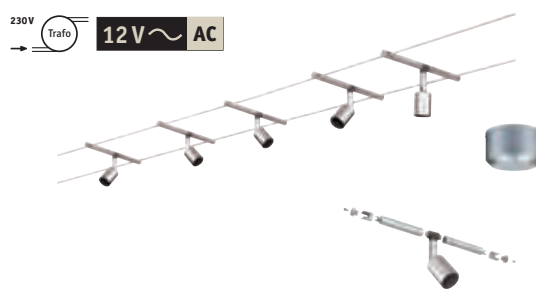

#### Set Spice Salt A++-E

max. 5×10 W, GU5,3  
 230/12 V, incl. 80 VA  
 160 mm 2,5 mm<sup>2</sup> ⇔ 10 m  
 EAN 4000870 941454  
**941.45 new**

#### Spot Salt A++-E

max. 10 W, GU5,3  
 12 V  
 160 ⇕ 30 ⇕ 115 ø51  
 ø64 mm  
 EAN 4000870 941393  
**941.39 new**





12V ~ AC

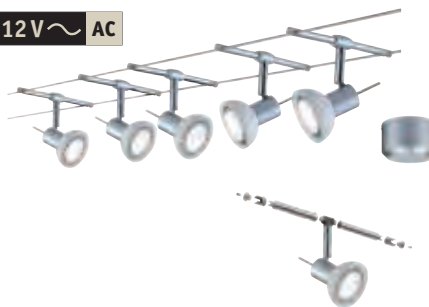

**Set Sheela**

A++-E

max. 5×10 W, GU5,3  
230/12 V, incl. ⚡ 60 VA  
⚡ 160 mm 2,5 mm<sup>2</sup> ↔ 10 m  
EAN 4000870 941362

**941.36 new**

**Spot Sheela**

A++-E

max. 10 W, GU5,3  
12 V  
⚡ 160 ⚡ 30 ⚡ 120 ø65  
ø95 mm

EAN 4000870 941317

**941.31 new**



- 🔗 Chrome matt/Opal 📦 Metal/Glass
- 🔗 Cromo mate/Opal 📦 Metal/Cristal
- 🔗 Cromo opaco/Opale 📦 Metallo/Vetro

💡 283.30



12V ~ AC

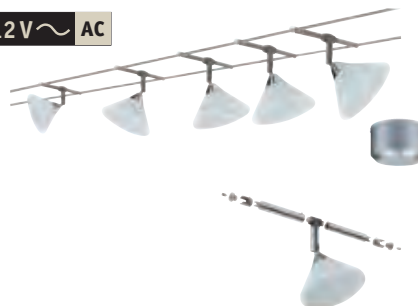

**Set Colmar**

A++-E

max. 5×10 W, GU4  
230/12 V, incl. ⚡ 80 VA  
⚡ 160 mm 2,5 mm<sup>2</sup> ↔ 10 m  
EAN 4000870 941430

**941.43 new**

**Spot Colmar**

A++-E

max. 10 W, GU4  
12 V  
⚡ 160 ⚡ 30 ⚡ 110 ø85  
ø80 mm

EAN 4000870 941386

**941.38 new**

- 🔗 Chrome/Satin 📦 Metal/Glass
- 🔗 Cromo/Satinado 📦 Metal/Cristal
- 🔗 Cromo/Satinato 📦 Metallo/Vetro

💡 283.29

**Spot Fennel**

A++-E

max. 2x10W, G4  
12V↔160 ↔30 ↕36 ↔120 ↗140 mm  
EAN 4000870 941409**941.40 new**

- 🌀 Chrome matt/Satin 📦 Metal/Glass
- 🌀 Cromo mate/Satinado 📦 Metal/Cristal
- 🌀 Cromo opaco/Satinato 📦 Metallo/Vetro

💡 282.76

**Spot Comet**

A++-E

max. 50W, GU5,3  
12V↕300 ↗300 mm  
EAN 4000870 971130**971.1229**

- 🌀 Chrome 📦 Metal
- 🌀 Cromo 📦 Metal
- 🌀 Cromo 📦 Metallo

💡 832.04

**Spot Light stick**

A++-E

max. 50W, GU5,3  
12V↕500 ↗500 mm  
EAN 4000870 971239**971.229**

- 🌀 Chrome 📦 Metal
- 🌀 Cromo 📦 Metal
- 🌀 Cromo 📦 Metallo

💡 832.04

**DC Spot Plate**

A++-A

incl. 1x1,7W  
64 lm, 2.700K  
12V↔160 ↕94 ø125 mm  
EAN 4000870 952207**952.20 new**

- 🌀 Chrome/Matt white 📦 Metal/Plastic
- 🌀 Cromo/Blanco mate 📦 Metal/Plástico
- 🌀 Cromo/Bianco opaco 📦 Metallo/Plastica

**DC Spot Lense**

A++-A

incl. 1x4,5W  
340 lm, 3.000K  
↘ 25°, 715 cd  
12V↔160 ↕165 ↔80 ↗32 mm  
EAN 4000870 940976**940.97 new**

- 🌀 Chrome/White 📦 Metal/Plastic
- 🌀 Cromo/Blanco 📦 Metal/Plástico
- 🌀 Cromo/Bianco 📦 Metallo/Plastica

Combine your own personal lighting system  
 Combine usted mismo su sistema de luz personal  
 Scegliete voi stessi le combinazioni per il vostro sistema d'illuminazione personalizzato

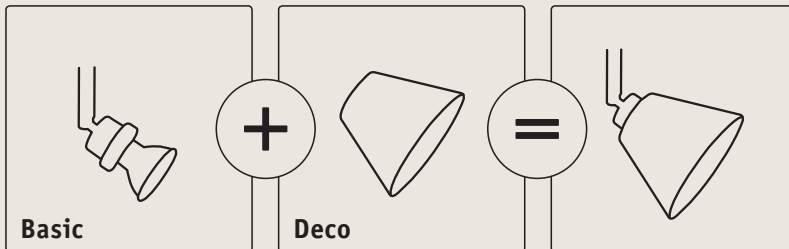

**Spot Basic**

max. 10 W, GU5,3  
 12 V  
 ⚙️ 160 ⚙️ 30 ⚙️ 130 ⚙️ 95 ⚙️ 75 mm  
 EAN 4000870 941416

**941.41 new**

- 🔗 Chrome matt 🏠 Metal
- 🔗 Cromo mate 🏠 Metal
- 🔗 Cromo opaco 🏠 Metallo

🔗 283.30

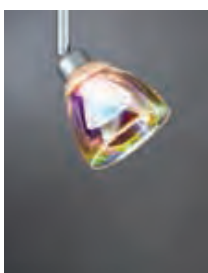

**Wolbi**

max. 50 W  
 ⚙️ 80 ⚙️ 90 mm  
 EAN 4000870 600115

**600.11**

- 🔗 Dichroic 🏠 Glass
- 🔗 Dicroico 🏠 Cristal
- 🔗 Dicroico 🏠 Vetro

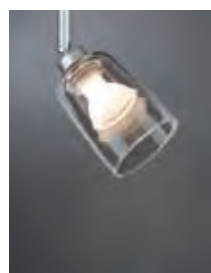

**Rado**

max. 50 W  
 ⚙️ 95 ⚙️ 70 mm  
 EAN 4000870 953556

**953.55**

- 🔗 Clear 🏠 Glass
- 🔗 Transparente 🏠 Cristal
- 🔗 Trasparente 🏠 Vetro

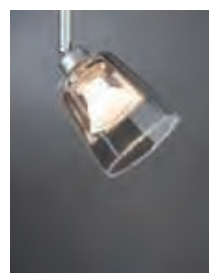

**Vico**

max. 50 W  
 ⚙️ 95 ⚙️ 80 mm  
 EAN 4000870 953570

**953.57**

- 🔗 Clear 🏠 Glass
- 🔗 Transparente 🏠 Cristal
- 🔗 Trasparente 🏠 Vetro



**Twice**

max. 50 W  
 ⚙️ 70 ⚙️ 100 mm  
 EAN 4000870 701744

**701.74 new**

- 🔗 Clear/Opaque 🏠 Glass
- 🔗 Transparente/Opaco 🏠 Cristal
- 🔗 Trasparente/Opaco 🏠 Vetro

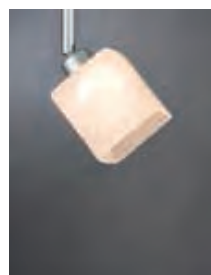
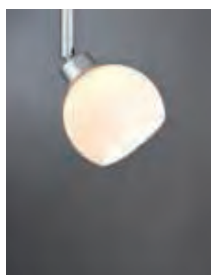
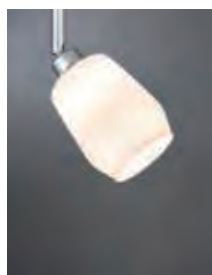
**Vento**

max. 50 W  
 ⚡ 95 ø80 mm  
 EAN 4000870 953594  
**953.59**

- 🌀 Smoke glass 🗄 Glass
- 🌀 Vidrio ahumado 🗄 Cristal
- 🌀 Vetro opaco 🗄 Vetro

**Vento**

max. 50 W  
 ⚡ 95 ø80 mm  
 EAN 4000870 953587  
**953.58**

- 🌀 Satin 🗄 Glass
- 🌀 Satinado 🗄 Cristal
- 🌀 Satinato 🗄 Vetro

**Wolbi**

max. 50 W  
 ⚡ 70 ø90 mm  
 EAN 4000870 600559  
**600.55**

- 🌀 Opal 🗄 Glass
- 🌀 Opal 🗄 Cristal
- 🌀 Opale 🗄 Vetro

**Quad**

max. 50 W  
 ⚡ 80 ø75 mm  
 EAN 4000870 600153  
**600.15**

- 🌀 White 🗄 Glass
- 🌀 Blanco 🗄 Cristal
- 🌀 Bianco 🗄 Vetro

**Kegi**

max. 50 W  
 ⚡ 80 ø110 mm  
 EAN 4000870 600122  
**600.12**

- 🌀 White 🗄 Glass
- 🌀 Blanco 🗄 Cristal
- 🌀 Bianco 🗄 Vetro

**Wolbi**

max. 50 W  
 ⚡ 80 ø90 mm  
 EAN 4000870 600078  
**600.07**

- 🌀 White 🗄 Glass
- 🌀 Blanco 🗄 Cristal
- 🌀 Bianco 🗄 Vetro

**Turno**

max. 50 W  
 ⚡ 90 ø80 mm  
 EAN 4000870 953563  
**953.56**

- 🌀 Satin 🗄 Glass
- 🌀 Satinado 🗄 Cristal
- 🌀 Satinato 🗄 Vetro

**Zyli**

max. 50 W  
 ⚡ 80 ø70 mm  
 EAN 4000870 600047  
**600.04**

- 🌀 White 🗄 Glass
- 🌀 Blanco 🗄 Cristal
- 🌀 Bianco 🗄 Vetro

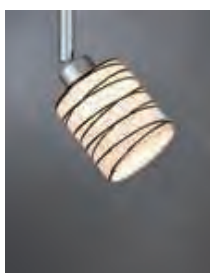
**Zyli**

max. 50 W  
 ⚡ 80 ø70 mm  
 EAN 4000870 600535  
**600.53**

- 🌀 Opal/Black 🗄 Glass
- 🌀 Opal/Negro 🗄 Cristal
- 🌀 Opale/Nero 🗄 Vetro

**Zyli**

max. 50 W  
 ⚡ 80 ø70 mm  
 EAN 4000870 600061  
**600.06**

- 🌀 Brown 🗄 Glass
- 🌀 Marrón 🗄 Cristal
- 🌀 Marrone 🗄 Vetro

**Wolbi**

max. 50 W  
 ⚡ 80 ø90 mm  
 EAN 4000870 600085  
**600.08**

- 🌀 White 🗄 Metal
- 🌀 Blanco 🗄 Metal
- 🌀 Bianco 🗄 Metallo

**Wolbi**

max. 50 W  
 ⚡ 80 ø90 mm  
 EAN 4000870 600092  
**600.09**

- 🌀 White/Aluminium 🗄 Metal
- 🌀 Blanco/Aluminio 🗄 Metal
- 🌀 Bianco/Alluminio 🗄 Metallo



**DecoSystems Diffusor**

max. 20 W  
 ⌀152 ø255 mm  
 EAN 4000870 954935

**954.93** **new**

- Satin Plastic
- Satinado Plástico
- Satinato Plastica



**Tessa**  
 max. 50 W  
 ⌀152 ø255 mm  
 EAN 4000870 603499  
**603.49** **new**  
 Dark brown Fabric  
 Marrón oscuro Tela  
 Marrone scuro Tessuto



**Tessa**  
 max. 50 W  
 ⌀152 ø255 mm  
 EAN 4000870 603529  
**603.52** **new**  
 Light grey Fabric  
 Gris claro Tela  
 Grigio chiaro Tessuto



**Tessa**  
 max. 50 W  
 ⌀152 ø255 mm  
 EAN 4000870 603512  
**603.51** **new**  
 Cream Fabric  
 Crema Tela  
 Crema Tessuto



**Tessa**  
 max. 50 W  
 ⌀152 ø255 mm  
 EAN 4000870 603505  
**603.50** **new**  
 Caramel Fabric  
 Caramelo Tela  
 Caramello Tessuto



**Tessa**  
 max. 50 W  
 ⌀152 ø255 mm  
 EAN 4000870 603246  
**603.24**  
 Blue Fabric  
 Azul Tela  
 Blu Tessuto



**Tessa**  
 max. 50 W  
 ⌀152 ø255 mm  
 EAN 4000870 603253  
**603.25**  
 Yellow Fabric  
 Amarillo Tela  
 Giallo Tessuto



**Tessa**  
 max. 50 W  
 ⌀152 ø255 mm  
 EAN 4000870 603260  
**603.26**  
 White Fabric  
 Blanco Tela  
 Bianco Tessuto



**Tessa**  
 max. 50 W  
 ⌀152 ø255 mm  
 EAN 4000870 603277  
**603.27**  
 Apricot Fabric  
 Albaricoque Tela  
 Apricot Tessuto







### 2Easy Basic 12V AC

A++-E

- Grey Plastic
- Gris Plástico
- Grigio Plastica

max. 105 W  
 230/12 V, incl. 105 VA  
 110 mm ø180 mm 2,5 mm²  
 10 m  
 EAN 4000870 940037  
**940.03**



### Set Basic 12V DC

A++-E

- Chrome matt Metal
- Cromo mate Metal
- Cromo opaco Metallo

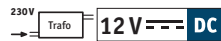

230/12 V, incl. 36 VA  
 40 mm 4 mm² 210 mm  
 60 mm 15 m  
 EAN 4000870 940969  
**940.96**



### Safety tension wire, insulated Cable tensor de seguridad, aislado Cavo tenditore di sicurezza, isolato

- Clear Copper/Plastic
- Transparente Cobre/Plástico
- Trasparente Rame/Plastica

2,5 mm² 12 m  
 EAN 4000870 979693  
**979.069**

4 mm² 8 m  
 EAN 4000870 979594  
**979.059**

4 mm² 12 m  
 EAN 4000870 979556  
**979.055**

4 mm² 100 m  
 EAN 4000870 006566  
**979.057**

6 mm² 12 m  
 EAN 4000870 979471  
**979.047**

6 mm² 100 m  
 EAN 4000870 006573  
**979.067**

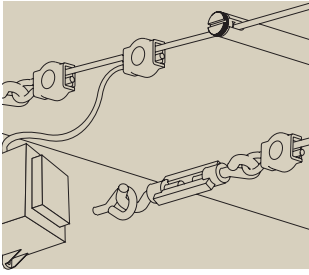

**Safety wire terminal, for power input, 1 pair**  
**Sujetacables de seguridad, para alimentación eléctrica, 1 unidades**  
**Serracavo di sicurezza per l'alimentazione della corrente, 1 coppia**

2x



- ☞ Chrome ☐ Metal
- ☞ Cromo ☐ Metal
- ☞ Cromo ☐ Metallo

max. 300 W  
 EAN 4000870 978290  
**978.029** 📦

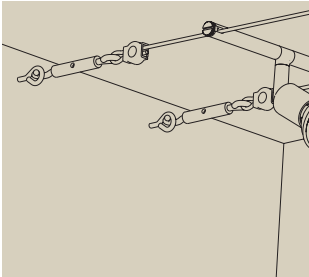

**Tension fitting kit, uninsulated**  
**Set de montaje de elementos de tensión, no aislado**  
**Set di montaggio a trazione, non isolato**

2x

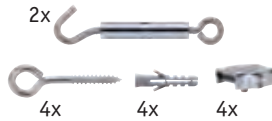

- ☞ Chrome ☐ Metal
- ☞ Cromo ☐ Metal
- ☞ Cromo ☐ Metallo

EAN 4000870 178034  
**178.03** 📦

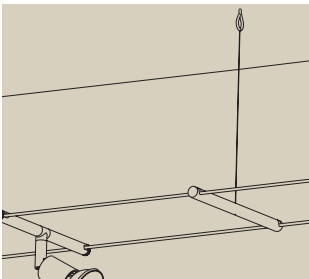

**Intermediate suspender**  
**Suspensión intermedia**  
**Sospensione intermedia**



- ☞ Clear ☐ Plastic
- ☞ Transparente ☐ Plástico
- ☞ Trasparente ☐ Plastica

⌀160 ⌀12 ⇄170 mm  
 EAN 4000870 178140  
**178.14** 📦

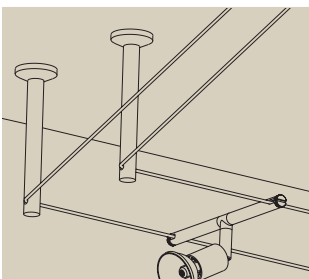

**Diverter / Suspension screw-fitted mount, 1 pair**  
**Diversor / Suspensión, para atornillar, 2 unidades**  
**Deviatore / Sospensione, da avvitare, 1 coppia**

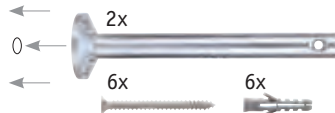

- ☞ Chrome matt ☐ Metal
- ☞ Cromo mate ☐ Metal
- ☞ Cromo opaco ☐ Metallo

⌀165 ⌀16 mm  
 EAN 4000870 178065  
**178.06** 📦

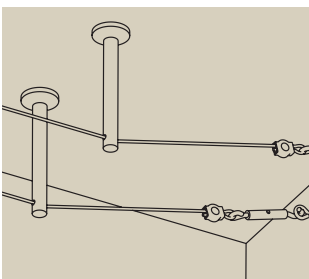

**Diverter / Suspension screw-fitted mount, 1 pair**  
**Diversor / Suspensión, para atornillar, 2 unidades**  
**Deviatore / Sospensione, da avvitare, 1 coppia**

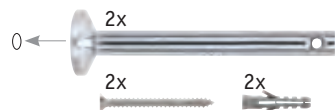

- ☞ Chrome ☐ Metal
- ☞ Cromo ☐ Metal
- ☞ Cromo ☐ Metallo

⌀165 ⌀16 mm  
 EAN 4000870 178249  
**178.24** 📦

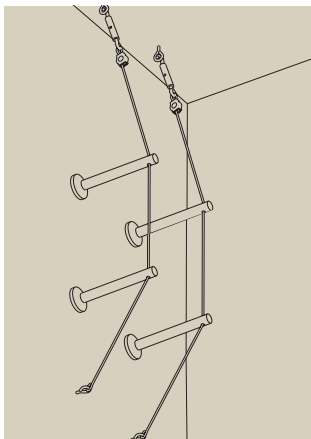

**Tension fitting kit**  
**Set de montaje de elementos de tensión**  
**Set di montaggio a trazione**

- ☞ Chrome ☐ Metal
- ☞ Cromo ☐ Metal
- ☞ Cromo ☐ Metallo

↑165 ø16 mm  
 EAN 4000870 178348  
**178.34** ➡

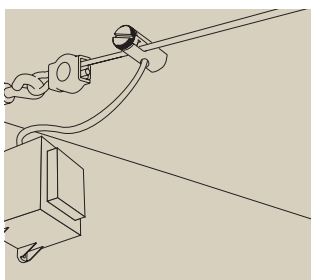
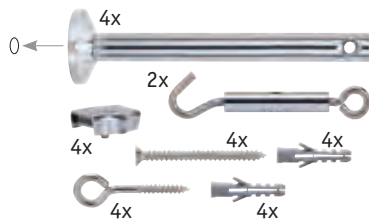

**Power Input, 1 pair**  
**Alimentación Eléctrica, 2 unidades**  
**Alimentazione, 1 coppia**

- ☞ Chrome matt ☐ Metal
- ☞ Cromo mate ☐ Metal
- ☞ Cromo opaco ☐ Metallo

max. 300W  
 12V  
 ↑30 mm ø12 mm 6 mm<sup>2</sup>  
 EAN 4000870 972830  
**972.83** ➡

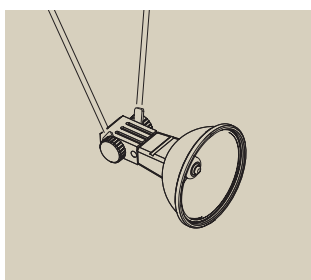

**Socket bulb fitting for wire systems**  
**Portalámparas Socket, para sistemas de cables**  
**Porta-lampada Socket per sistemi a cavi**

- ☞ Black ☐ Metal
- ☞ Negro ☐ Metal
- ☞ Nero ☐ Metallo

max. 35W, G4  
 12V  
 EAN 4000870 978412  
**978.41** ➡

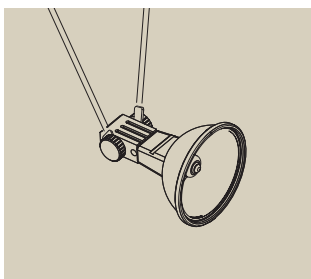

**Socket bulb fitting for wire systems**  
**Portalámparas Socket, para sistemas de cables**  
**Porta-lampada Socket per sistemi a cavi**

- ☞ Black ☐ Metal
- ☞ Negro ☐ Metal
- ☞ Nero ☐ Metallo

max. 50W, GX5,3  
 12V  
 EAN 4000870 978450  
**978.45** ➡



- ☞ White ☐ Metal
- ☞ Blanco ☐ Metal
- ☞ Bianco ☐ Metallo

max. 50W, GX5,3  
 12V  
 EAN 4000870 978443  
**978.44** ➡

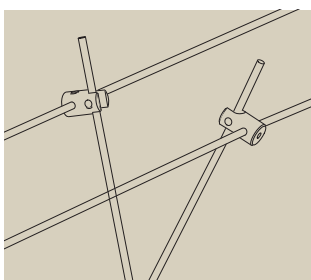

**Wire block for wire systems max. 150W / rod systems max. 300W, double pack**  
**Cilindro para sistemas de cables máx. 150W / Sistemas de barras máx. 300W pack de dos unidades**  
**Blocchetto del cavo per sistemi a cavi max. 150W / sistemi ad aste max. 300W in confezione doppia**

- ☞ Chrome ☐ Metal
- ☞ Cromo ☐ Metal
- ☞ Cromo ☐ Metallo

max. 150W  
 12V  
 EAN 4000870 978191  
**978.019** ➡



# Rail Systems

133 URail

172 Rail LED/12V



138 Spot Dipper



173 Spot IceLED





#### URail – the flexible 230V rail system from Paulmann

Maximal multifunctionality: URail is the universal 230 V-rail system for direct ceiling mounting or otherwise with ceiling clearance and that completely without transformer. Complete sets, spots (3 different types), pendants and the rails are available in the material colours chrome matt or white.

#### URail – El flexible sistema de raíles a 230V de Paulmann

Máxima versatilidad: URail es el sistema universal de raíles de 230 V para el montaje directo en el techo o con separación opcional del techo, sin necesidad de transformador. Tanto juegos completos como focos (en 3 diferentes tecnologías de iluminación), lámparas colgantes y raíles están disponibles en material de color cromo mate o blanco.

#### URail – Il sistema di illuminazione a binario flessibile da 230 V Paulmann

Massima versatilità: URail è il sistema di illuminazione universale a binario da 230 V per il montaggio diretto a soffitto o, a scelta, con distanza dal soffitto. Il tutto senza l'impiego di trasformatore. Set completi, spot (in tre soluzioni illuminotecniche), sospensioni e binari disponibili nei colori cromo opaco o bianco.





CM



**LED End Cap**

A++-A

incl. 1×5,8W  
501 lm, 2.700 K  
∠ 80°  
230 V  
∅27 ⇄141 ∅57 mm  
EAN 4000870 954799

**954.79** **new**

- Chrome matt Metal
- Cromo mate Metal
- Cromo opaco Metallo

LED



CM



**LED Line Connector**

A++-A

incl. 1×5,8W  
501 lm, 2.700 K  
∠ 80°  
230 V  
∅27 ⇄225 ∅57 mm  
EAN 4000870 954775

**954.77** **new**

- Chrome matt Metal
- Cromo mate Metal
- Cromo opaco Metallo

LED



CM



**LED L-Connector**

A++-A

incl. 1×5,8W  
501 lm, 2.700 K  
∠ 80°  
230 V  
∅27 ⇄141 ∅141 mm  
EAN 4000870 954850

**954.85** **new**

- Chrome matt Metal
- Cromo mate Metal
- Cromo opaco Metallo

LED



CM



**LED T-Connector**

A++-A

incl. 1×5,8W  
501 lm, 2.700 K  
∠ 80°  
230 V  
∅27 ⇄224 ∅141 mm  
EAN 4000870 954836

**954.83** **new**

- Chrome matt Metal
- Cromo mate Metal
- Cromo opaco Metallo

LED



CM



**LED Y-Connector**

A++-A

incl. 1×5,8W  
501 lm, 2.700 K  
∠ 80°  
230 V  
∅27 ⇄223 ∅195 mm  
EAN 4000870 954812

**954.81** **new**

- Chrome matt Metal
- Cromo mate Metal
- Cromo opaco Metallo

LED





Inline Twenty



Inline Fourty

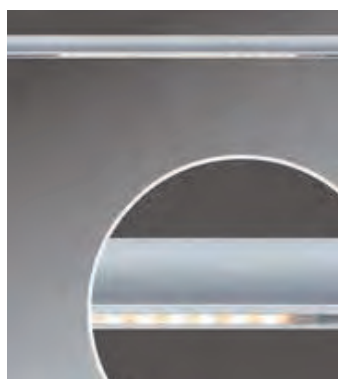

Inline Twenty

**Spot Inline Twenty**

incl. 1x2 W  
108 lm, 2.700 K  
230 V  
⌀16 ⇄200 ⌀8,5 mm  
EAN 4000870 952917

**952.91** **new**

- Transparent Plástico
- Transparente Plástico
- Trasparente Plastica

A++-A

LED

**Spot Inline Fourty**

incl. 1x3,3 W  
222 lm, 2.700 K  
230 V  
⌀16 ⇄400 ⌀8,5 mm  
EAN 4000870 952924

**952.92** **new**

- Transparent Plástico
- Transparente Plástico
- Trasparente Plastica

A++-A

LED

**Spot Inline Ninety**

incl. 1x5,2 W  
501 lm, 2.700 K  
230 V  
⌀16 ⇄900 ⌀8,5 mm  
EAN 4000870 952931

**952.93** **new**

- Transparent Plástico
- Transparente Plástico
- Trasparente Plastica

A++-A

LED





CM



CM



CM

**Panel Double**

A++-A

incl. 1x8 W  
695 lm, 2.700 K  
230 V  
⌀30 ⇄288 ↗127 mm  
EAN 4000870 953099

A++-A

**Panel Ring**

incl. 1x7 W  
812 lm, 2.700 K  
230 V  
∅220 ↗30 mm  
EAN 4000870 953150

**953.15**

- ☞ Chrome matt/Chrome
- ☞ Die cast aluminium/Plastic
- ☞ Cromo mate/Cromo
- ☞ Aluminio inyectado a presión/Plástico
- ☞ Cromo opaco/Cromo
- ☞ Alluminio pressofuso/Plastica

**Panel Loop**

incl. 1x7 W  
812 lm, 2.700 K  
230 V  
⌀35 ⇄380 ↗110 mm  
EAN 4000870 953198

**953.19**

- ☞ Chrome matt/Chrome
- ☞ Die cast aluminium/Plastic
- ☞ Cromo mate/Cromo
- ☞ Aluminio inyectado a presión/Plástico
- ☞ Cromo opaco/Cromo
- ☞ Alluminio pressofuso/Plastica



CM

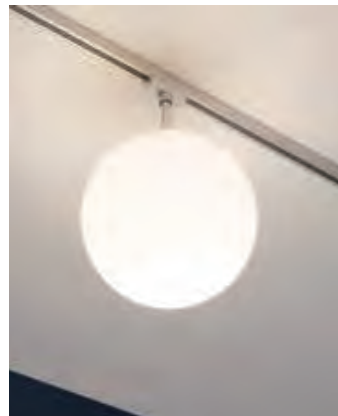

CM



CM

**Ceiling Globe Big**

A++-E

max. 20 W, E27  
230 V  
⌀420 ∅300 mm  
EAN 4000870 976043

**976.04 new**

- ☞ Chrome matt/Opal ☞ Metal/Glass
- ☞ Cromo mate/Opal ☞ Metal/Cristal
- ☞ Cromo opaco/Opale ☞ Metallo/Vetro

⚡ 282.26  
282.98  
283.49  
500.11  
500.12  
500.13

**Ceiling Globe Small**

max. 10 W, E14  
230 V  
⌀320 ∅200 mm  
EAN 4000870 976029

**976.02 new**

- ☞ Chrome matt/Opal ☞ Metal/Glass
- ☞ Cromo mate/Opal ☞ Metal/Cristal
- ☞ Cromo opaco/Opale ☞ Metallo/Vetro

⚡ 283.52

**Spot Blade**

incl. 1x14,4 W  
1.240 lm, 2.700 K  
230 V  
⌀256 ⇄400 ↗55 mm  
EAN 4000870 954348

**954.34 new**

- ☞ Chrome matt/Chrome ☞ Metal
- ☞ Cromo mate/Cromo ☞ Metal
- ☞ Cromo opaco/Cromo ☞ Metallo

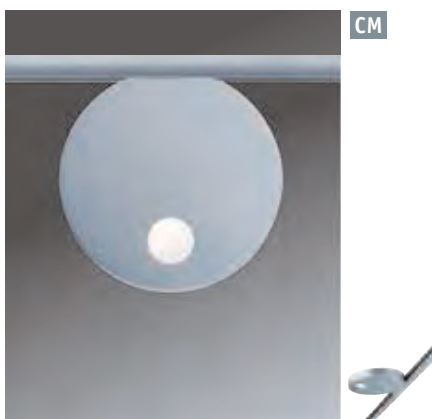

### Spot Uplight Salto

incl. 1×16W  
1.316 lm, 2.700 K  
230V  
⌀19 ⇄135 ↗130 mm  
EAN 4000870 953211

**953.21**

- 🌀 Chrome matt  Metal
- 🌀 Cromo mate  Metal
- 🌀 Cromo opaco  Metallo

A++-A

LED

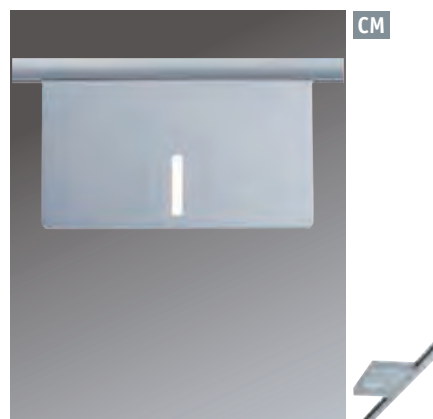

### Spot Uplight Case

incl. 1×16W  
1.408 lm, 2.700 K  
230V  
⌀19 ⇄165 ↗90 mm  
EAN 4000870 953235

**953.23**

- 🌀 Chrome matt  Metal
- 🌀 Cromo mate  Metal
- 🌀 Cromo opaco  Metallo

A++-A

LED





CM

**Wall Spot Discus**

incl. 1x5,5 W  
440 lm, 2.700 K  
∠ 45°  
230 V  
∅95 ∅410 mm  
EAN 4000870 954546

**954.54 new**

- ☞ Chrome matt Metal
- ☞ Cromo mate Metal
- ☞ Cromo opaco Metallo

A++-A



R, C



On/Off



CM

**Wall Spot Torch**

incl. 1x5,5 W  
440 lm, 2.700 K  
230 V  
∅37 ∅43 ∅486 mm  
EAN 4000870 954522

**954.52 new**

- ☞ Chrome matt Metal
- ☞ Cromo mate Metal
- ☞ Cromo opaco Metallo

A++-A



R, C



On/Off



CM

**Wall Spot Knob**

incl. 1x5,5 W  
440 lm, 2.700 K  
∠ 45°  
230 V  
∅75 ∅51 ∅380 mm  
EAN 4000870 954539

**954.53 new**

- ☞ Chrome matt Metal
- ☞ Cromo mate Metal
- ☞ Cromo opaco Metallo

A++-A



R, C



On/Off



CM

**Spot Dipper**

incl. 2x8 W  
2x652 lm, 2.700 K  
∠ 83°  
230 V  
∅170 ∅375 ∅26 mm  
EAN 4000870 954690

**954.69 new**

- ☞ Chrome matt/White Metal
- ☞ Cromo mate/Blanco Metal
- ☞ Cromo opaco/Bianco Metallo

A++-A

LED



R, L, C



CM

**Spot Double Pellet**

incl. 2x4 W  
2x294 lm, 2.700 K  
∠ 40°  
230 V  
∅180 ∅190 ∅40 mm  
EAN 4000870 954713

**954.71 new**

- ☞ Chrome matt/White Metal
- ☞ Cromo mate/Blanco Metal
- ☞ Cromo opaco/Bianco Metallo

A++-A

LED



R, L, C



CM

**Spot Pellet**

incl. 1x4 W  
294 lm, 2.700 K  
∠ 40°  
230 V  
∅180 ∅80 ∅40 mm  
EAN 4000870 954737

**954.73 new**

- ☞ Chrome matt/White Metal
- ☞ Cromo mate/Blanco Metal
- ☞ Cromo opaco/Bianco Metallo

A++-A

LED



R, L, C



		
<p><b>Spot Capsule II</b> <span style="float: right;">A++-A</span></p> <p>incl. 1x6 W 420 lm, 2.700 K ∠ 30° 230 V ∅210 ∅80 ∅80 mm EAN 4000870 954553 <b>954.55 new</b></p> <p>☞ Chrome matt/Chrome ☒ Metal ☞ Cromo mate/Cromo ☒ Metal ☞ Cromo opaco/Cromo ☒ Metallo</p>	<p><b>Spot Capsule</b> <span style="float: right;">A++-A</span></p> <p>incl. 1x4,5 W 241 lm, 2.700 K ∠ 30° 230 V ∅210 ∅80 ∅80 mm EAN 4000870 952788 <b>952.78</b></p> <p>☞ Chrome matt/Chrome ☒ Metal ☞ Cromo mate/Cromo ☒ Metal ☞ Cromo opaco/Cromo ☒ Metallo</p>	<p><b>Spot Wankel</b> <span style="float: right;">A++-A</span></p> <p>incl. 1x5,4 W 450 lm, 2.700 K ∠ 35° 230 V ∅173 ∅55 ∅78 mm EAN 4000870 952047 <b>952.04</b></p> <p>☞ Chrome matt/Chrome ☒ Metal ☞ Cromo mate/Cromo ☒ Metal ☞ Cromo opaco/Cromo ☒ Metallo</p>

		
<p><b>Spot Pedal</b> <span style="float: right;">A++-A</span></p> <p>incl. 1x5 W 395 lm, 2.700 K ∠ 100° 230 V ∅175 ∅50 ∅48 mm EAN 4000870 952696 <b>952.69</b></p> <p>☞ Chrome matt ☒ Metal ☞ Cromo mate ☒ Metal ☞ Cromo opaco ☒ Metallo</p>	<p><b>Spot Circle</b> <span style="float: right;">A++-A</span></p> <p>incl. 1x5 W 308 lm, 2.700 K ∠ 90° 230 V ∅147 ∅98 ∅50 mm EAN 4000870 952719 <b>952.71</b></p> <p>☞ Chrome matt ☒ Metal ☞ Cromo mate ☒ Metal ☞ Cromo opaco ☒ Metallo</p>	<p><b>Spot Shine</b> <span style="float: right;">A++-A</span></p> <p>incl. 1x5 W 225 lm, 2.700 K ∠ 75° 230 V ∅180 ∅59 ∅90 mm EAN 4000870 952733 <b>952.73</b></p> <p>☞ Chrome matt ☒ Metal ☞ Cromo mate ☒ Metal ☞ Cromo opaco ☒ Metallo</p>



CM



CM



CM

**Spot Roncalli II**

A++-E

incl. 1x11W, GU10, <math>\langle A^+ \rangle</math>  
590 lm, 2.700 K  
230 V  
↑200 ø111 ↗110 mm  
EAN 4000870 952801

**952.80**

- ↳ Chrome matt Metal
- ↳ Cromo mate Metal
- ↳ Cromo opaco Metallo

💡 282.84  
500.14  
500.15  
500.21

**Spot Cone**

A++-E

incl. 1x6,5 W, GU10, <math>\langle A^{++} \rangle</math>  
425 lm, 2.700 K  
230 V  
↑180 ø85 ↗90 mm  
EAN 4000870 952283

**952.28**

- ↳ Chrome matt/Chrome Metal
- ↳ Cromo mate/Cromo Metal
- ↳ Cromo opaco/Cromo Metallo

💡 283.00  
500.14  
500.15  
500.21

**Spot Barelli**

A++-E

incl. 1x6,5 W, GU10, <math>\langle A^{++} \rangle</math>  
425 lm, 2.700 K  
230 V  
↑165 ø51 ↔100 ↗51 mm  
EAN 4000870 951545

**951.54**

- ↳ Chrome matt/Chrome Metal
- ↳ Cromo mate/Cromo Metal
- ↳ Cromo opaco/Cromo Metallo

💡 283.00  
500.14  
500.15  
500.21



CM



CM



CM

**Spot Tube**

A++-E

incl. 1x6,5 W, GU10, <math>\langle A^{++} \rangle</math>  
425 lm, 2.700 K  
230 V  
↑112 ø65 mm  
EAN 4000870 952856

**952.85**

- ↳ Chrome matt/Chrome Metal
- ↳ Cromo mate/Cromo Metal
- ↳ Cromo opaco/Cromo Metallo

💡 283.00  
500.14  
500.15  
500.21

**Spot Pipe**

A++-E

incl. 1x3,5 W, GU10, <math>\langle A^{++} \rangle</math>  
230 lm, 2.700 K  
230 V  
↑150 ø65 ↗100 mm  
EAN 4000870 952276

**952.27**

- ↳ Chrome matt/Chrome Metal
- ↳ Cromo mate/Cromo Metal
- ↳ Cromo opaco/Cromo Metallo

💡 282.99  
500.14  
500.15  
500.21

**Spot Kundry**

A++-E

incl. 1x3 W, GU10, <math>\langle A^{++} \rangle</math>  
250 lm, 2.700 K  
230 V  
↑175 ø60 ↗140 mm  
EAN 4000870 951170

**951.17**

- ↳ Chrome matt/Opal Metal/Glass
- ↳ Cromo mate/Opal Metal/Cristal
- ↳ Cromo opaco/Opale Metallo/Vetro

💡 282.24

**Spot Titurel II**

incl. 1x2,2 W, G9, A++

200 lm, 2.700 K

230 V

⌀225 ⌀60 ↗150 mm

EAN 4000870 953075

**953.07**

☞ Chrome matt/Chrome ☒ Metal/Glass

☞ Cromo mate/Cromo ☒ Metal/Cristal

☞ Cromo opaco/Cromo ☒ Metallo/Vetro

💡 283.38

A++-E

LED

**Spot Pipe**

max. 10 W, GU10

230 V

⌀150 ⌀65 ↗100 mm

EAN 4000870 976128

**976.12 new**

☞ Chrome matt/Chrome ☒ Metal

☞ Cromo mate/Cromo ☒ Metal

☞ Cromo opaco/Cromo ☒ Metallo

💡 283.45

283.00

A++-E

LED

**Spot Cone**

max. 10 W, GU10

230 V

⌀180 ⌀85 ↗90 mm

EAN 4000870 976135

**976.13 new**

☞ Chrome matt/Chrome ☒ Metal

☞ Cromo mate/Cromo ☒ Metal

☞ Cromo opaco/Cromo ☒ Metallo

💡 283.45

283.00

A++-E

LED

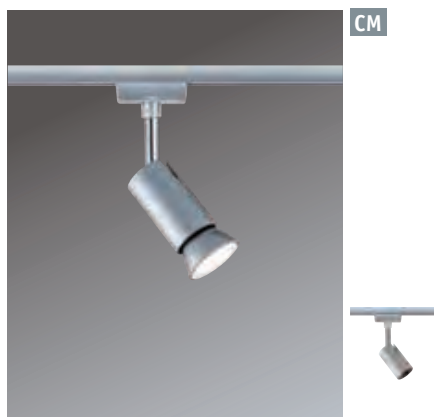
**Spot Pure I**

max. 10 W, GU10

230 V

⌀110 ↔58 ↗66 mm

EAN 4000870 953297

**953.29 new**

☞ Chrome matt/Chrome ☒ Metal

☞ Cromo mate/Cromo ☒ Metal

☞ Cromo opaco/Cromo ☒ Metallo

💡 283.00

283.45

500.14

500.15

500.21

A++-E

LED





CM



**Spot Pure II**

A++-E

max. 10 W, GU10  
230 V  
↑110 ↔58 ↗66 mm  
EAN 4000870 953310

**953.31 new**

- ☞ Chrome matt/Chrome ☒ Metal
- ☞ Cromo mate/Cromo ☒ Metal
- ☞ Cromo opaco/Cromo ☒ Metallo

💡 283.00  
284.34  
500.14  
500.15  
500.21

A++-E



**Starter Set Pure II**

A++-E

max. 3×10 W, GU10  
230 V  
↔1,2 m  
EAN 4000870 954638

**954.63 new**

- ☞ Chrome matt/Chrome ☒ Metal
- ☞ Cromo mate/Cromo ☒ Metal
- ☞ Cromo opaco/Cromo ☒ Metallo

💡 283.00  
284.34  
500.14  
500.15  
500.21

A++-E



CM



**Spot Barelli**

A++-E

max. 10 W, GU10  
230 V  
↑138 ↔68 ↗35 mm  
EAN 4000870 954614

**954.61 new**

- ☞ Chrome matt/Chrome ☒ Metal
- ☞ Cromo mate/Cromo ☒ Metal
- ☞ Cromo opaco/Cromo ☒ Metallo

💡 283.00  
284.34  
500.14  
500.15  
500.21

A++-E



**Starter Set Barelli**

A++-E

max. 3×10 W, GU10  
230 V  
↔1,2 m  
EAN 4000870 954591

**954.59 new**

- ☞ Chrome matt/Chrome ☒ Metal
- ☞ Cromo mate/Cromo ☒ Metal
- ☞ Cromo opaco/Cromo ☒ Metallo

💡 283.00  
284.34  
500.14  
500.15  
500.21

A++-E

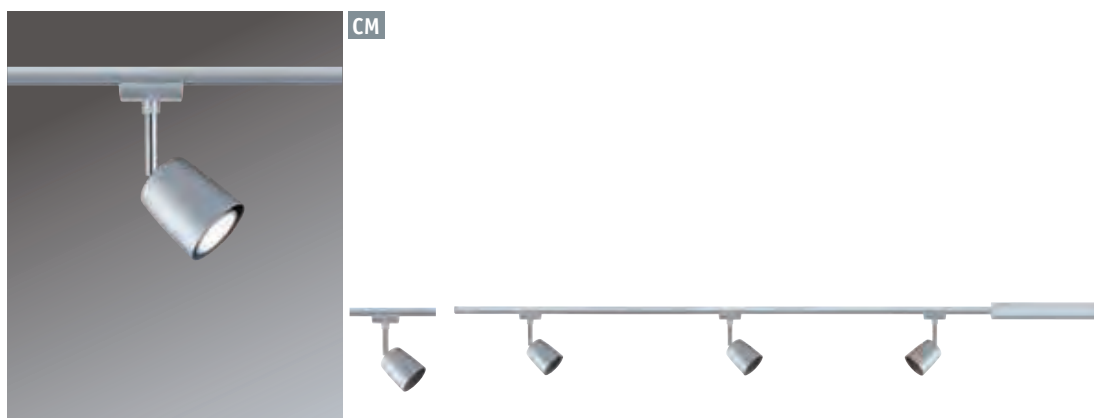

**Spot Cover**

max. 10 W, GU10

230 V

⌀140 ⇄58 ↗90 mm

EAN 4000870 953358

**953.35 new**

🌀 Chrome matt/Chrome 🗄 Metal

🌀 Cromo mate/Cromo 🗄 Metal

🌀 Cromo opaco/Cromo 🗄 Metallo

💡 283.00

500.14

500.15

500.21

A++-E

LED

**Starter Set Cover**

max. 3×10 W, GU10

230 V

⇄1,2 m

EAN 4000870 954621

**954.62 new**

🌀 Chrome matt/Chrome 🗄 Metal

🌀 Cromo mate/Cromo 🗄 Metal

🌀 Cromo opaco/Cromo 🗄 Metallo

💡 283.00

284.34

500.14

500.15

500.21

A++-E

LED







CM

**Spot Blossom**

A++-E

max. 10 W, G9  
230 V  
⌀128 ↔74 ↗115 mm  
EAN 4000870 953372

**953.37 new**

- ☞ Chrome matt/Satin ☒ Metal/Glass
- ☞ Cromo mate/Satinado ☒ Metal/Cristal
- ☞ Cromo opaco/Satinato ☒ Metallo/Vetro

💡 283.38  
284.46



CM

**Spot Blossom**

A++-E

max. 10 W, G9  
230 V  
⌀128 ↔74 ↗115 mm  
EAN 4000870 953389

**953.38 new**

- ☞ Chrome matt/Clear/Satin ☒ Metal/Glass
- ☞ Cromo mate/Transparente/Satinado ☒ Metal/Cristal
- ☞ Cromo opaco/Trasparente/Satinato ☒ Metallo/Vetro

💡 283.38  
284.46



CM

**Spot Blossom**

A++-E

max. 10 W, G9  
230 V  
⌀128 ↔74 ↗115 mm  
EAN 4000870 953396

**953.39 new**

- ☞ Chrome matt/Smoke glass ☒ Metal/Glass
- ☞ Cromo mate/Vidrio ahumado ☒ Metal/Cristal
- ☞ Cromo opaco/Vetro opaco ☒ Metallo/Vetro

💡 283.38  
284.46



CM

**Spot Blossom**

A++-E

max. 10 W, G9  
230 V  
⌀128 ↔74 ↗115 mm  
EAN 4000870 953402

**953.40 new**

- ☞ Chrome matt/Purple/Transparent ☒ Metal/Glass
- ☞ Cromo mate/Lila/Transparente ☒ Metal/Cristal
- ☞ Cromo opaco/Lilla/Trasparente ☒ Metallo/Vetro

💡 283.38  
284.46

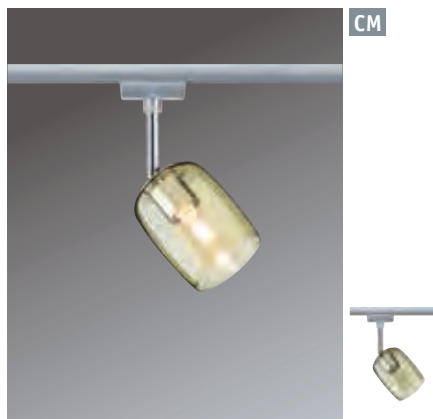

CM

**Spot Blossom**

A++-E

max. 10 W, G9  
230 V  
⌀128 ↔74 ↗115 mm  
EAN 4000870 953419

**953.41 new**

- ☞ Chrome matt/Transparent yellow ☒ Metal/Glass
- ☞ Cromo mate/Amarillo transparente ☒ Metal/Cristal
- ☞ Cromo opaco/Giallo trasparente ☒ Metallo/Vetro

💡 283.38  
284.46





CM



CM



CM

**Pendulum Capsule II**

incl. 1x6 W  
420 lm, 2.700 K  
230 V  
∅ 130 cm ∅ 87 mm  
EAN 4000870 954577

**954.57 new**

- ☞ Chrome matt/Chrome ☐ Metal
- ☞ Cromo mate/Cromo ☐ Metal
- ☞ Cromo opaco/Cromo ☐ Metallo

A++-A

LED



R, L, C

**Pendulum Capsule**

incl. 1x4,5 W  
238 lm, 2.700 K  
230 V  
∅ 130 cm ∅ 87 mm  
EAN 4000870 952740

**952.74**

- ☞ Chrome matt/Chrome ☐ Metal
- ☞ Cromo mate/Cromo ☐ Metal
- ☞ Cromo opaco/Cromo ☐ Metallo

A++-A

LED

**LED Pendulum Barrel**

incl. 1x6 W  
370 lm, 2.700 K  
∠ 106°, 139 cd  
230 V  
∅ 135 cm ∅ 85 mm  
EAN 4000870 951774

**951.77**

- ☞ Chrome matt/Aluminium ☐ Metal
- ☞ Cromo mate/Aluminio ☐ Metal
- ☞ Cromo opaco/Alluminio ☐ Metallo

A++-A

LED



R, L, C



CM



CM

**Arido**

A++-AA+-E

incl. 1x3 W, GZ10,

250 lm, 2.700 K

230 V

↑200 mm ↑158 cm ø110 mm

EAN 4000870 953600

**953.60**

- Chrome matt/Clear/Satin Glass
- Cromo mate/Transparente/Satinado
- Cristal
- Cromo opaco/Trasparente/Satinato
- Vetro

282.24  
284.18



**Remo**

A++-AA+-E

incl. 1x3 W, GZ10,

250 lm, 2.700 K

230 V

↑200 mm ↑158 cm ø125 mm

EAN 4000870 953617

**953.61**

- Chrome matt/Satin Glass
- Cromo mate/Satinado Cristal
- Cromo opaco/Satinato Vetro

282.24  
284.18



CM



CM

**Pendulum Sarrasani**

A+-E

max. 10 W, GU10

230 V

↑135 cm ø140 mm

EAN 4000870 954515

**954.51 new**

- Chrome matt/Dichroic Metal/Glass
- Cromo mate/Dicroico Metal/Cristal
- Cromo opaco/Dicroico Metallo/Vetro

282.86  
500.14  
500.15  
500.21



**Pendulum Sarrasani**

A+-E

max. 10 W, GU10

230 V

↑135 cm ø140 mm

EAN 4000870 954508

**954.50 new**

- Chrome matt/Opal Metal/Glass
- Cromo mate/Opal Metal/Cristal
- Cromo opaco/Opale Metallo/Vetro

282.86  
500.14  
500.15  
500.21





*Combine your own personal lighting system*

*Combine usted mismo su sistema de luz personal*

*Scegliete voi stessi le combinazioni per il vostro sistema d'illuminazione personalizzato*

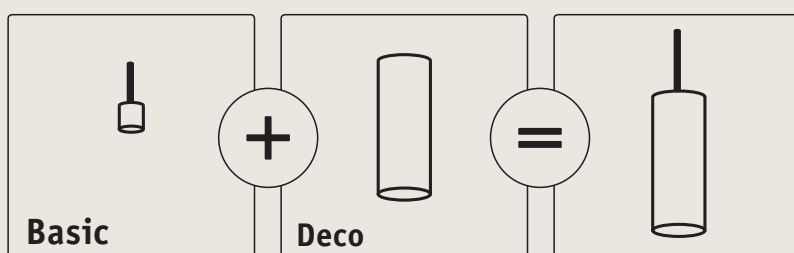



CM

**2Easy Basic Pendulum**

max. 20 W, E27  
230 V

∅150 cm ↔1,5 m

EAN 4000870 954362

**954.36 new**

- ☞ Chrome matt/Chrome ☐ Metal
- ☞ Cromo mate/Cromo ☐ Metal
- ☞ Cromo opaco/Cromo ☐ Metallo

💡 283.28  
500.11  
500.12  
500.13

A++-E



**Livo**

∅280 ∅75 mm  
EAN 4000870 998427

**998.42**

- ☞ Opal ☐ Glass
- ☞ Opal ☐ Cristal
- ☞ Opale ☐ Vetro



**Shade Pien**

max. 50 W

∅230 ∅250 mm  
EAN 4000870 954430

**954.43 new**

- ☞ Pink matt ☐ Metal
- ☞ Rosa mate ☐ Metal
- ☞ Rosa opaco ☐ Metallo



**Shade Pirm**

max. 50 W

∅230 ∅280 mm  
EAN 4000870 954409

**954.40 new**

- ☞ Grey matt ☐ Metal
- ☞ Gris mate ☐ Metal
- ☞ Grigio opaco ☐ Metallo



**Shade Pien**

max. 50 W

∅230 ∅250 mm  
EAN 4000870 954423

**954.42 new**

- ☞ Beige matt ☐ Metal
- ☞ Beige mate ☐ Metal
- ☞ Beige opaco ☐ Metallo



**Shade Pom**

max. 50 W

∅240 ∅350 mm  
EAN 4000870 954386

**954.38 new**

- ☞ Matt white ☐ Metal
- ☞ Blanco mate ☐ Metal
- ☞ Bianco opaco ☐ Metallo



**Vento**

∅280 ∅170 mm  
EAN 4000870 953518

**953.51 new**

- ☞ Clear ☐ Glass
- ☞ Transparente ☐ Cristal
- ☞ Trasparente ☐ Vetro



**Drio**

∅280 ∅152 mm  
EAN 4000870 953525

**953.52 new**

- ☞ Smoke glass ☐ Glass
- ☞ Vidrio ahumado ☐ Cristal
- ☞ Vetro opaco ☐ Vetro



**Vico**

∅280 ∅150 mm  
EAN 4000870 953532

**953.53 new**

- ☞ Satin ☐ Glass
- ☞ Satinado ☐ Cristal
- ☞ Satinato ☐ Vetro

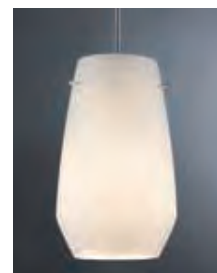

**Vento**

∅280 ∅170 mm  
EAN 4000870 953549

**953.54 new**

- ☞ Opal ☐ Glass
- ☞ Opal ☐ Cristal
- ☞ Opale ☐ Vetro





**2Easy Diffusor**

max. 20 W  
 ⚙️ 260 ø454 mm  
 EAN 4000870 954928

**954.92** 🆕 **new**

- 🌀 Satin 🏠 Plástico
- 🌀 Satinado 🏠 Plástico
- 🌀 Satinato 🏠 Plastica

**Tessa**

max. 50 W  
 ⚙️ 260 ø454 mm  
 EAN 4000870 954652

**954.65** **new**

- 🌀 Light grey 🏠 Fabric
- 🌀 Gris claro 🏠 Tela
- 🌀 Grigio chiaro 🏠 Tessuto

**Tessa**

max. 50 W  
 ⚙️ 260 ø454 mm  
 EAN 4000870 954669

**954.66** **new**

- 🌀 Cream 🏠 Fabric
- 🌀 Crema 🏠 Tela
- 🌀 Crema 🏠 Tessuto

**Tessa**

max. 50 W  
 ⚙️ 260 ø454 mm  
 EAN 4000870 954676

**954.67** **new**

- 🌀 Caramel 🏠 Fabric
- 🌀 Caramelo 🏠 Tela
- 🌀 Caramello 🏠 Tessuto

**Tessa**

max. 50 W  
 ⚙️ 260 ø454 mm  
 EAN 4000870 954683

**954.68** **new**

- 🌀 Dark brown 🏠 Fabric
- 🌀 Marrón oscuro 🏠 Tela
- 🌀 Marrone scuro 🏠 Tessuto

**Tessa**

max. 50 W  
 ⚙️ 260 ø454 mm  
 EAN 4000870 953648

**953.64**

- 🌀 Blue 🏠 Fabric
- 🌀 Azul 🏠 Tela
- 🌀 Blu 🏠 Tessuto

**Tessa**

max. 50 W  
 ⚙️ 260 ø454 mm  
 EAN 4000870 953655

**953.65**

- 🌀 Yellow 🏠 Fabric
- 🌀 Amarillo 🏠 Tela
- 🌀 Giallo 🏠 Tessuto

**Tessa**

max. 50 W  
 ⚙️ 260 ø454 mm  
 EAN 4000870 953662

**953.66**

- 🌀 White 🏠 Fabric
- 🌀 Blanco 🏠 Tela
- 🌀 Bianco 🏠 Tessuto

**Tessa**

max. 50 W  
 ⚙️ 260 ø454 mm  
 EAN 4000870 953679

**953.67**

- 🌀 Apricot 🏠 Fabric
- 🌀 Albaricoque 🏠 Tela
- 🌀 Apricot 🏠 Tessuto

Combine your own personal lighting system  
 Combine usted mismo su sistema de luz personal  
 Scegliete voi stessi le combinazioni per il vostro sistema d'illuminazione personalizzato

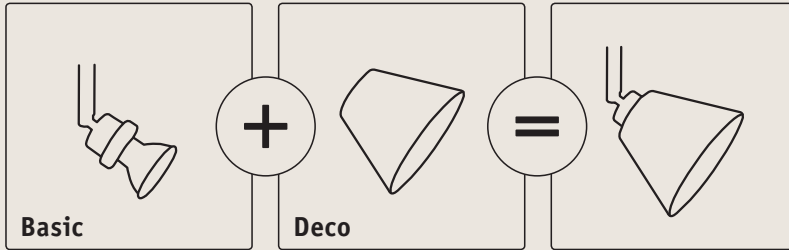

**Basic-Spot**

incl. 1x3,5 W, GZ10,  $\triangleleft$  A+  
 250 lm, 2.700 K  
 230 V  
 $\updownarrow$  125  $\varnothing$  51  $\varnothing$  50 mm  
 EAN 4000870 951828  
**951.82**

- $\hookrightarrow$  Chrome matt  $\square$  Metal
- $\hookrightarrow$  Cromo mate  $\square$  Metal
- $\hookrightarrow$  Cromo opaco  $\square$  Metallo

$\hookrightarrow$  281.87  
 500.14  
 500.15  
 500.21

A++-E

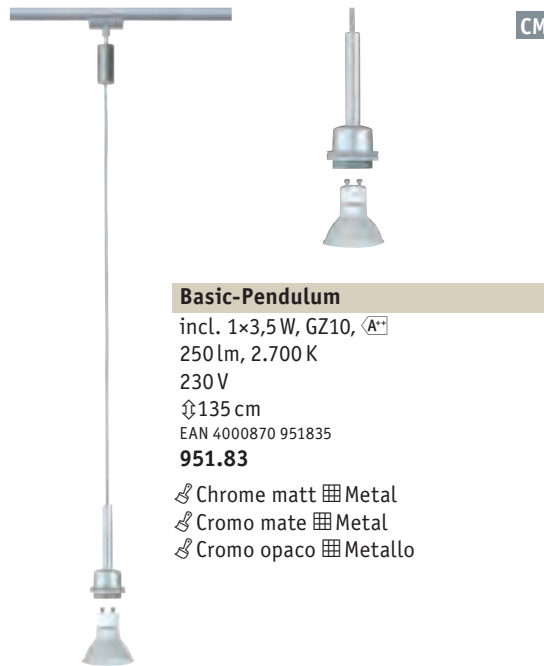

**Basic-Pendulum**

incl. 1x3,5 W, GZ10,  $\triangleleft$  A+  
 250 lm, 2.700 K  
 230 V  
 $\updownarrow$  135 cm  
 EAN 4000870 951835  
**951.83**

- $\hookrightarrow$  Chrome matt  $\square$  Metal
- $\hookrightarrow$  Cromo mate  $\square$  Metal
- $\hookrightarrow$  Cromo opaco  $\square$  Metallo

A++-E

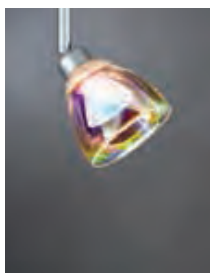

**Wolbi**

max. 50 W  
 $\updownarrow$  80  $\varnothing$  90 mm  
 EAN 4000870 600115  
**600.11**

- $\hookrightarrow$  Dichroic  $\square$  Glass
- $\hookrightarrow$  Dicroico  $\square$  Cristal
- $\hookrightarrow$  Dicroico  $\square$  Vetro

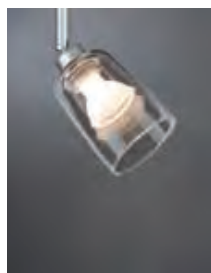

**Rado**

max. 50 W  
 $\updownarrow$  95  $\varnothing$  70 mm  
 EAN 4000870 953556  
**953.55**

- $\hookrightarrow$  Clear  $\square$  Glass
- $\hookrightarrow$  Transparente  $\square$  Cristal
- $\hookrightarrow$  Trasparente  $\square$  Vetro



**Vico**

max. 50 W  
 $\updownarrow$  95  $\varnothing$  80 mm  
 EAN 4000870 953570  
**953.57**

- $\hookrightarrow$  Clear  $\square$  Glass
- $\hookrightarrow$  Transparente  $\square$  Cristal
- $\hookrightarrow$  Trasparente  $\square$  Vetro



**Twice**

max. 50 W  
 $\updownarrow$  70  $\varnothing$  100 mm  
 EAN 4000870 701744  
**701.74 new**

- $\hookrightarrow$  Clear/Opaque  $\square$  Glass
- $\hookrightarrow$  Transparente/Opaco  $\square$  Cristal
- $\hookrightarrow$  Trasparente/Opaco  $\square$  Vetro

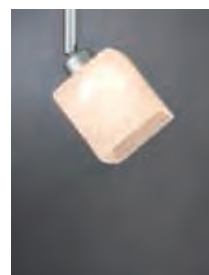

**Vento**

max. 50 W  
 ⚙ 95 ø80 mm  
 EAN 4000870 953594  
**953.59**

- 🌀 Smoke glass 🗪 Glass
- 🌀 Vidrio ahumado 🗪 Cristal
- 🌀 Vetro opaco 🗪 Vetro

**Vento**

max. 50 W  
 ⚙ 95 ø80 mm  
 EAN 4000870 953587  
**953.58**

- 🌀 Satin 🗪 Glass
- 🌀 Satinado 🗪 Cristal
- 🌀 Satinato 🗪 Vetro

**Wolbi**

max. 50 W  
 ⚙ 70 ø90 mm  
 EAN 4000870 600559  
**600.55**

- 🌀 Opal 🗪 Glass
- 🌀 Opal 🗪 Cristal
- 🌀 Opale 🗪 Vetro

**Quad**

max. 50 W  
 ⚙ 80 ø75 mm  
 EAN 4000870 600153  
**600.15**

- 🌀 White 🗪 Glass
- 🌀 Blanco 🗪 Cristal
- 🌀 Bianco 🗪 Vetro

**Kegi**

max. 50 W  
 ⚙ 80 ø110 mm  
 EAN 4000870 600122  
**600.12**

- 🌀 White 🗪 Glass
- 🌀 Blanco 🗪 Cristal
- 🌀 Bianco 🗪 Vetro

**Wolbi**

max. 50 W  
 ⚙ 80 ø90 mm  
 EAN 4000870 600078  
**600.07**

- 🌀 White 🗪 Glass
- 🌀 Blanco 🗪 Cristal
- 🌀 Bianco 🗪 Vetro

**Turno**

max. 50 W  
 ⚙ 90 ø80 mm  
 EAN 4000870 953563  
**953.56**

- 🌀 Satin 🗪 Glass
- 🌀 Satinado 🗪 Cristal
- 🌀 Satinato 🗪 Vetro

**Zyli**

max. 50 W  
 ⚙ 80 ø70 mm  
 EAN 4000870 600047  
**600.04**

- 🌀 White 🗪 Glass
- 🌀 Blanco 🗪 Cristal
- 🌀 Bianco 🗪 Vetro

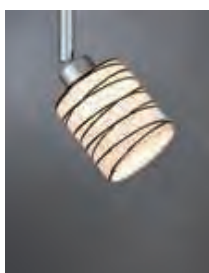
**Zyli**

max. 50 W  
 ⚙ 80 ø70 mm  
 EAN 4000870 600535  
**600.53**

- 🌀 Opal/Black 🗪 Glass
- 🌀 Opal/Negro 🗪 Cristal
- 🌀 Opale/Nero 🗪 Vetro

**Zyli**

max. 50 W  
 ⚙ 80 ø70 mm  
 EAN 4000870 600061  
**600.06**

- 🌀 Brown 🗪 Glass
- 🌀 Marrón 🗪 Cristal
- 🌀 Marrone 🗪 Vetro

**Wolbi**

max. 50 W  
 ⚙ 80 ø90 mm  
 EAN 4000870 600085  
**600.08**

- 🌀 White 🗪 Metal
- 🌀 Blanco 🗪 Metal
- 🌀 Bianco 🗪 Metallo

**Wolbi**

max. 50 W  
 ⚙ 80 ø90 mm  
 EAN 4000870 600092  
**600.09**

- 🌀 White/Aluminium 🗪 Metal
- 🌀 Blanco/Aluminio 🗪 Metal
- 🌀 Bianco/Alluminio 🗪 Metallo



**DecoSystems Diffusor**

max. 20 W  
 ⌀152 ø255 mm  
 EAN 4000870 954935

**954.93** **new**

- Satin Plastic
- Satinado Plástico
- Satinato Plastica



**Tessa**  
 max. 50 W  
 ⌀152 ø255 mm  
 EAN 4000870 603499  
**603.49** **new**  
 Dark brown Fabric  
 Marrón oscuro Tela  
 Marrone scuro Tessuto



**Tessa**  
 max. 50 W  
 ⌀152 ø255 mm  
 EAN 4000870 603529  
**603.52** **new**  
 Light grey Fabric  
 Gris claro Tela  
 Grigio chiaro Tessuto



**Tessa**  
 max. 50 W  
 ⌀152 ø255 mm  
 EAN 4000870 603512  
**603.51** **new**  
 Cream Fabric  
 Crema Tela  
 Crema Tessuto



**Tessa**  
 max. 50 W  
 ⌀152 ø255 mm  
 EAN 4000870 603505  
**603.50** **new**  
 Caramel Fabric  
 Caramelo Tela  
 Caramello Tessuto



**Tessa**  
 max. 50 W  
 ⌀152 ø255 mm  
 EAN 4000870 603246  
**603.24**  
 Blue Fabric  
 Azul Tela  
 Blu Tessuto



**Tessa**  
 max. 50 W  
 ⌀152 ø255 mm  
 EAN 4000870 603253  
**603.25**  
 Yellow Fabric  
 Amarillo Tela  
 Giallo Tessuto



**Tessa**  
 max. 50 W  
 ⌀152 ø255 mm  
 EAN 4000870 603260  
**603.26**  
 White Fabric  
 Blanco Tela  
 Bianco Tessuto



**Tessa**  
 max. 50 W  
 ⌀152 ø255 mm  
 EAN 4000870 603277  
**603.27**  
 Apricot Fabric  
 Albaricoque Tela  
 Apricot Tessuto

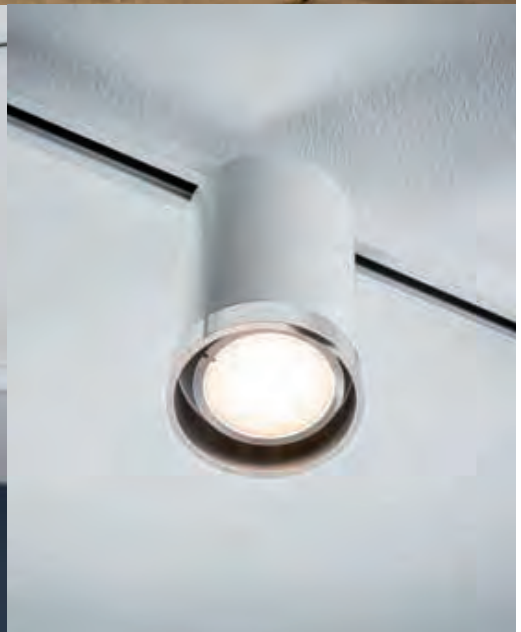





W



W



W

### LED End Cap

incl. 1x5,8W  
501 lm, 2.700 K  
∠ 80°  
230V  
⌀27 ⇄141 ⌀57 mm  
EAN 4000870 954805  
**954.80** **new**  
🌀 White Metal  
🌀 Blanco Metal  
🌀 Bianco Metallo

A++-A



### LED Line Connector

incl. 1x5,8W  
501 lm, 2.700 K  
∠ 80°  
230V  
⌀27 ⇄225 ⌀57 mm  
EAN 4000870 954782  
**954.78** **new**  
🌀 White Metal  
🌀 Blanco Metal  
🌀 Bianco Metallo

A++-A



### LED L-Connector

incl. 1x5,8W  
501 lm, 2.700 K  
∠ 80°  
230V  
⌀27 ⇄141 ⌀141 mm  
EAN 4000870 954867  
**954.86** **new**  
🌀 White Metal  
🌀 Blanco Metal  
🌀 Bianco Metallo

A++-A





W



W

**LED T-Connector**

A++-A

incl. 1×5,8W  
501 lm, 2.700 K  
∠ 80°  
230 V  
⌀27 ⇄224 ⌀141 mm  
EAN 4000870 954843

**954.84** **new**

🌀 White 🗍 Metal  
🌀 Blanco 🗍 Metal  
🌀 Bianco 🗍 Metallo

LED



R, L, C

**LED Y-Connector**

A++-A

incl. 1×5,8W  
501 lm, 2.700 K  
∠ 80°  
230 V  
⌀27 ⇄223 ⌀195 mm  
EAN 4000870 954829

**954.82** **new**

🌀 White 🗍 Metal  
🌀 Blanco 🗍 Metal  
🌀 Bianco 🗍 Metallo

LED

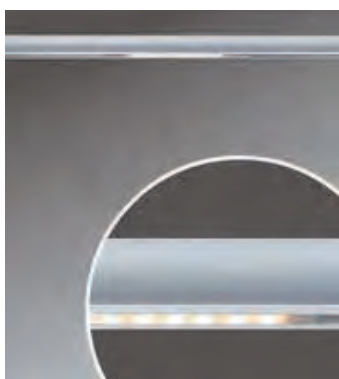

R, L, C

**Spot Inline Twenty**

A++-A

incl. 1×2 W  
108 lm, 2.700 K  
230 V  
⌀16 ⇄200 ⌀8,5 mm  
EAN 4000870 952917

**952.91** **new**

🌀 Transparent 🗍 Plástico  
🌀 Transparente 🗍 Plástico  
🌀 Trasparente 🗍 Plastica

LED

**Spot Inline Fourty**

A++-A

incl. 1×3,3 W  
222 lm, 2.700 K  
230 V  
⌀16 ⇄400 ⌀8,5 mm  
EAN 4000870 952924

**952.92** **new**

🌀 Transparent 🗍 Plástico  
🌀 Transparente 🗍 Plástico  
🌀 Trasparente 🗍 Plastica

LED

**Spot Inline Ninety**

A++-A

incl. 1×5,2 W  
501 lm, 2.700 K  
230 V  
⌀16 ⇄900 ⌀8,5 mm  
EAN 4000870 952931

**952.93** **new**

🌀 Transparent 🗍 Plástico  
🌀 Transparente 🗍 Plástico  
🌀 Trasparente 🗍 Plastica

LED



Inline Twenty



Inline Fourty



Inline Twenty

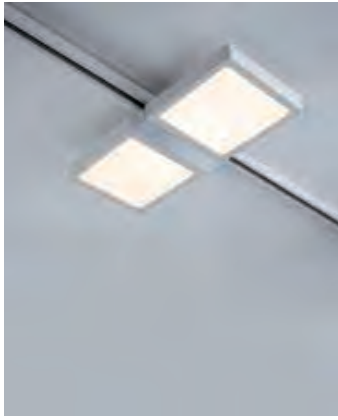

W



W



W

**Panel Double**

A++-A



incl. 1x8 W  
695 lm, 2.700 K  
230 V  
↑30 ↔288 ↗127 mm  
EAN 4000870 953105

**953.10**

- 🌀 White/Chrome 🗪 Die cast aluminium/Plastic
- 🌀 Blanco/Cromo
- 🗪 Aluminio inyectado a presión/Plástico
- 🌀 Bianco/Cromo 🗪 Alluminio pressofuso/Plastica

**Panel Ring**

A++-A



incl. 1x7 W  
812 lm, 2.700 K  
230 V  
ø220 ↗30 mm  
EAN 4000870 953167

**953.16**

- 🌀 White/Chrome 🗪 Die cast aluminium/Plastic
- 🌀 Blanco/Cromo
- 🗪 Aluminio inyectado a presión/Plástico
- 🌀 Bianco/Cromo 🗪 Alluminio pressofuso/Plastica

**Panel Loop**

A++-A



incl. 1x7 W  
812 lm, 2.700 K  
230 V  
↑35 ↔380 ↗110 mm  
EAN 4000870 953204

**953.20**

- 🌀 White/Chrome 🗪 Die cast aluminium/Plastic
- 🌀 Blanco/Cromo
- 🗪 Aluminio inyectado a presión/Plástico
- 🌀 Bianco/Cromo 🗪 Alluminio pressofuso/Plastica

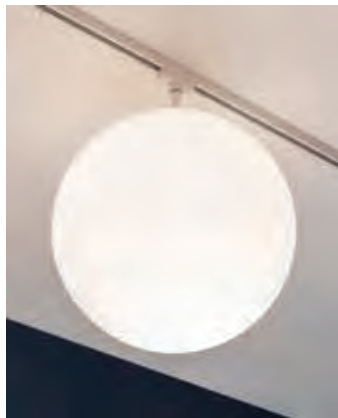

W

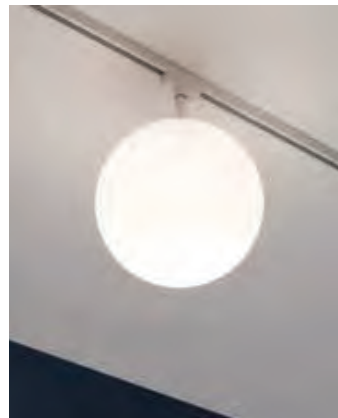

W

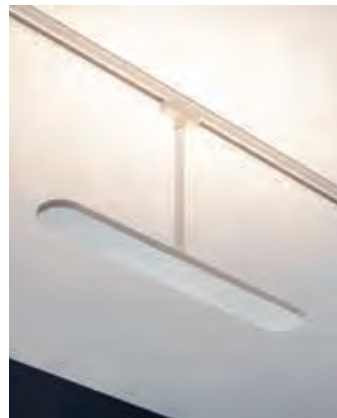

W

**Ceiling Globe Big**

A++-E



max. 20 W, E27  
230 V  
↑420 ø300 mm  
EAN 4000870 976050

**976.05 new**

- 🌀 White/Opal 🗪 Metal/Glass
- 🌀 Blanco/Opal 🗪 Metal/Cristal
- 🌀 Bianco/Opale 🗪 Metallo/Vetro

- 💡 282.26
- 282.98
- 283.49
- 500.11
- 500.12
- 500.13

**Ceiling Globe Small**

A++-E



max. 10 W, E14  
230 V  
↑320 ø200 mm  
EAN 4000870 976036

**976.03 new**

- 🌀 White/Opal 🗪 Metal/Glass
- 🌀 Blanco/Opal 🗪 Metal/Cristal
- 🌀 Bianco/Opale 🗪 Metallo/Vetro

- 💡 283.52

**Spot Blade**

A++-A



incl. 1x14,4 W  
1.240 lm, 2.700 K  
230 V  
↑256 ↔400 ↗55 mm  
EAN 4000870 954355

**954.35 new**

- 🌀 White/Chrome 🗪 Metal
- 🌀 Blanco/Cromo 🗪 Metal
- 🌀 Bianco/Cromo 🗪 Metallo

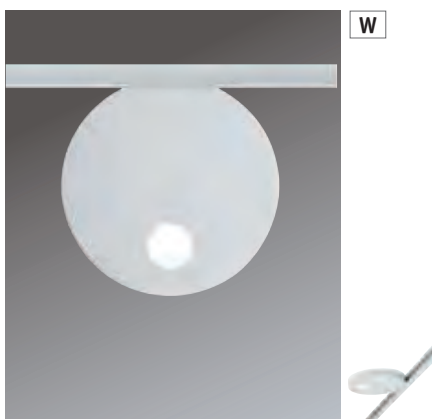
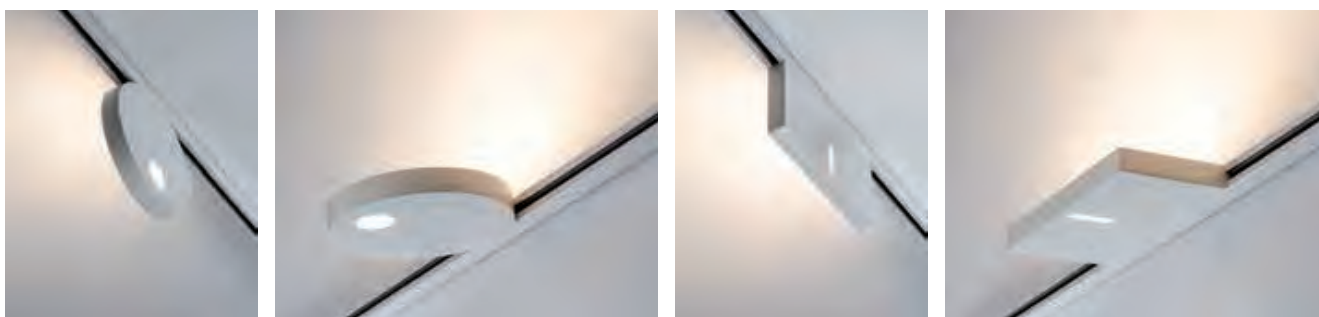

### Spot Uplight Salto

incl. 1×16W, GU10  
1.316 lm, 2.700 K  
230V  
↑19 ⇄135 ↗130 mm  
EAN 4000870 953228

**953.22**

🌀 White 🗪 Metal  
🌀 Blanco 🗪 Metal  
🌀 Bianco 🗪 Metallo

💡 283.00

A++-A

LED



### Spot Uplight Case

incl. 1×16W, GU10  
1.408 lm, 2.700 K  
230V  
↑19 ⇄165 ↗90 mm  
EAN 4000870 953242

**953.24**

🌀 White 🗪 Metal  
🌀 Blanco 🗪 Metal  
🌀 Bianco 🗪 Metallo

💡 283.00

A++-A

LED



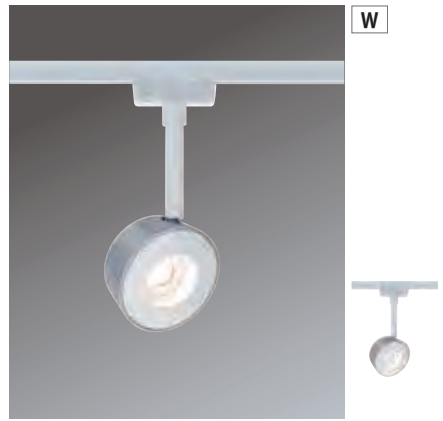

**Spot Dipper**

incl. 2x8 W  
2x652 lm, 2.700 K  
∠ 83°  
230 V  
∅170 ∅375 ∅26 mm  
EAN 4000870 954706

**954.70 new**

- ∞ White/Chrome M Metal
- ∞ Blanco/Cromo M Metal
- ∞ Bianco/Cromo M Metallo

A++-A

LED



**Spot Double Pellet**

incl. 2x4 W  
2x294 lm, 2.700 K  
∠ 40°  
230 V  
∅180 ∅190 ∅40 mm  
EAN 4000870 954720

**954.72 new**

- ∞ White/Chrome M Metal
- ∞ Blanco/Cromo M Metal
- ∞ Bianco/Cromo M Metallo

A++-A

LED



**Spot Pellet**

incl. 1x4 W  
294 lm, 2.700 K  
∠ 40°  
230 V  
∅180 ∅80 ∅40 mm  
EAN 4000870 954744

**954.74 new**

- ∞ White/Chrome M Metal
- ∞ Blanco/Cromo M Metal
- ∞ Bianco/Cromo M Metallo

A++-A

LED



**Spot Capsule II**

incl. 1x6 W  
420 lm, 2.700 K  
∠ 30°  
230 V  
∅210 ∅80 ∅80 mm  
EAN 4000870 954560

**954.56 new**

- ∞ White/Chrome M Metal
- ∞ Blanco/Cromo M Metal
- ∞ Bianco/Cromo M Metallo

A++-A

LED



**Spot Capsule**

incl. 1x4,5 W  
241 lm, 2.700 K  
∠ 30°  
230 V  
∅210 ∅80 ∅80 mm  
EAN 4000870 952795

**952.79**

- ∞ White/Chrome M Metal
- ∞ Blanco/Cromo M Metal
- ∞ Bianco/Cromo M Metallo

A++-A

LED



**Spot Wankel**

incl. 1x5,4 W  
450 lm, 2.700 K  
∠ 35°  
230 V  
∅173 ∅55 ∅78 mm  
EAN 4000870 952054

**952.05**

- ∞ White/Chrome M Metal
- ∞ Blanco/Cromo M Metal
- ∞ Bianco/Cromo M Metallo

A++-A

LED





**Spot Pedal**

incl. 1×5 W  
395 lm, 2.700 K  
∠ 100°  
230 V  
∅175 ∅50 ∅48 mm  
EAN 4000870 952702

**952.70**

🌀 White 🗄 Metal  
🌀 Blanco 🗄 Metal  
🌀 Bianco 🗄 Metallo

A++-A

**Spot Circle**

incl. 1×5 W  
308 lm, 2.700 K  
∠ 90°  
230 V  
∅147 ∅98 ∅50 mm  
EAN 4000870 952726

**952.72**

🌀 White 🗄 Metal  
🌀 Blanco 🗄 Metal  
🌀 Bianco 🗄 Metallo

A++-A

**Spot Shine**

incl. 1×5 W  
225 lm, 2.700 K  
∠ 75°  
230 V  
∅180 ∅59 ∅90 mm  
EAN 4000870 952832

**952.83**

🌀 White 🗄 Metal  
🌀 Blanco 🗄 Metal  
🌀 Bianco 🗄 Metallo

A++-A

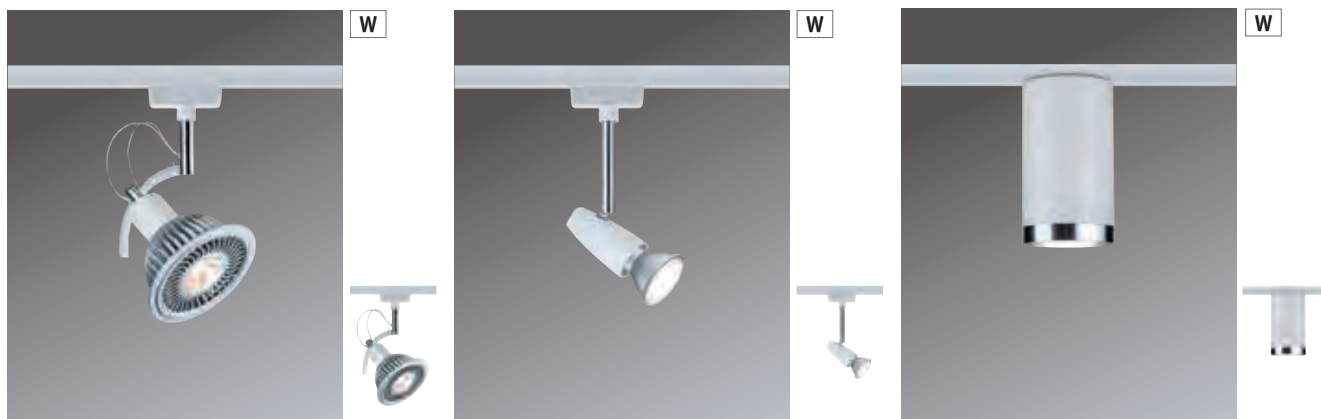
**Spot Roncalli II**

incl. 1×11 W, GU10, <math>\langle A^+ \rangle</math>  
590 lm, 2.700 K  
230 V  
∅200 ∅111 ∅110 mm  
EAN 4000870 952818

**952.81**

🌀 White 🗄 Metal  
🌀 Blanco 🗄 Metal  
🌀 Bianco 🗄 Metallo

💡 282.84  
500.21  
500.14  
500.15

A+-E

**Spot Barelli**

incl. 1×6,5 W, GU10, <math>\langle A^+ \rangle</math>  
425 lm, 2.700 K  
230 V  
∅165 ∅51 ∅100 ∅51 mm  
EAN 4000870 951552

**951.55**

🌀 White/Chrome 🗄 Metal  
🌀 Blanco/Cromo 🗄 Metal  
🌀 Bianco/Cromo 🗄 Metallo

💡 283.00  
500.14  
500.15  
500.21

A++-E

**Spot Tube**

incl. 1×6,5 W, GU10, <math>\langle A^+ \rangle</math>  
425 lm, 2.700 K  
230 V  
∅112 ∅65 mm  
EAN 4000870 952863

**952.86**

🌀 White/Chrome 🗄 Metal  
🌀 Blanco/Cromo 🗄 Metal  
🌀 Bianco/Cromo 🗄 Metallo

💡 283.00  
500.14  
500.15  
500.21

A++-E





**Spot Titurel II**

incl. 1x2,2W, G9, **A++**  
 200lm, 2.700K  
 230V  
 ⌀225 ⌀60 ↗150mm  
 EAN 4000870 953082

**953.08**

- 🌀 White/Chrome 🧱 Metal/Glass
- 🌀 Blanco/Cromo 🧱 Metal/Cristal
- 🌀 Bianco/Cromo 🧱 Metallo/Vetro

💡 283.38

A++-E



**Spot Cone**

max. 10W, GU10  
 230V  
 ⌀180 ⌀85 ↗90mm  
 EAN 4000870 953624

**953.62 new**

- 🌀 White/Chrome 🧱 Metal
- 🌀 Blanco/Cromo 🧱 Metal
- 🌀 Bianco/Cromo 🧱 Metallo

💡 283.00  
 283.45  
 500.14  
 500.15  
 500.21

A++-E



**Spot Pipe**

max. 10W, GU10  
 230V  
 ⌀150 ⌀65 ↗100mm  
 EAN 4000870 953631

**953.63 new**

- 🌀 White/Chrome 🧱 Metal
- 🌀 Blanco/Cromo 🧱 Metal
- 🌀 Bianco/Cromo 🧱 Metallo

💡 283.00  
 283.45  
 500.14  
 500.15  
 500.21

A++-E

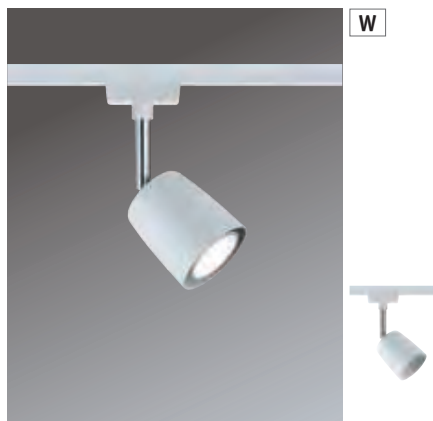

**Spot Pure I**

max. 10W, GU10  
 230V  
 ⌀110 ↔58 ↗66mm  
 EAN 4000870 953303

**953.30 new**

- 🌀 White/Chrome 🧱 Metal
- 🌀 Blanco/Cromo 🧱 Metal
- 🌀 Bianco/Cromo 🧱 Metallo

💡 283.00  
 283.45  
 500.14  
 500.15  
 500.21

A++-E



**Spot Pure II**

max. 10W, GU10  
 230V  
 ⌀110 ↔58 ↗66mm  
 EAN 4000870 953334

**953.33 new**

- 🌀 White/Chrome 🧱 Metal
- 🌀 Blanco/Cromo 🧱 Metal
- 🌀 Bianco/Cromo 🧱 Metallo

💡 283.00  
 283.45  
 500.14  
 500.15  
 500.21

A++-E



**Spot Cover**

max. 10W, GU10  
 230V  
 ⌀140 ↔58 ↗90mm  
 EAN 4000870 953365

**953.36 new**

- 🌀 White/Chrome 🧱 Metal
- 🌀 Blanco/Cromo 🧱 Metal
- 🌀 Bianco/Cromo 🧱 Metallo

💡 283.00  
 283.45  
 500.14  
 500.15  
 500.21

A++-E



**Spot Blossom**

max. 10 W, G9  
230 V  
⌀128 ⇄74 ↗115 mm  
EAN 4000870 953426

**953.42 new**

- 🌀 White/Satin 🗪 Metal/Glass
- 🌀 Blanco/Satinado 🗪 Metal/Cristal
- 🌀 Bianco/Satinato 🗪 Metallo/Vetro

💡 283.38  
284.46

A++-E

LED

**Spot Blossom**

max. 10 W, G9  
230 V  
⌀128 ⇄74 ↗115 mm  
EAN 4000870 953433

**953.43 new**

- 🌀 White/Clear/Satin 🗪 Metal/Glass
- 🌀 Blanco/Transparente/Satinado 🗪 Metal/Cristal
- 🌀 Bianco/Trasparente/Satinato 🗪 Metallo/Vetro

💡 283.38  
284.46

A++-E

LED

**Spot Blossom**

max. 10 W, G9  
230 V  
⌀128 ⇄74 ↗115 mm  
EAN 4000870 953440

**953.44 new**

- 🌀 White/Transparent grey 🗪 Metal/Glass
- 🌀 Blanco/Gris transparente 🗪 Metal/Cristal
- 🌀 Bianco/Grigio trasparente 🗪 Metallo/Vetro

💡 283.38  
284.46

A++-E

LED

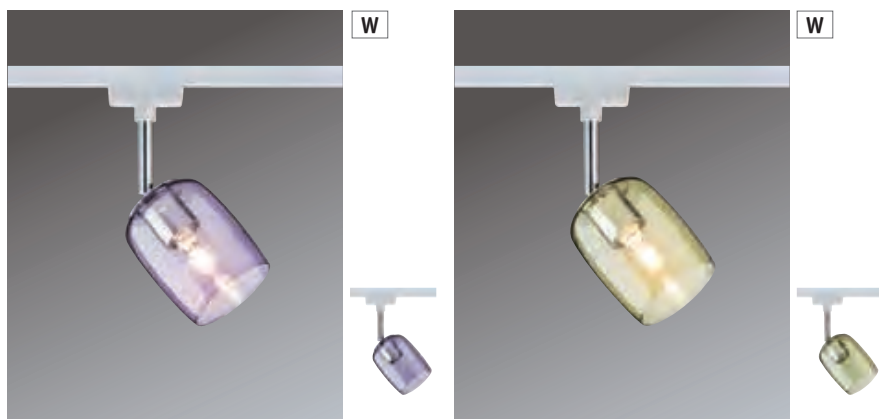
**Spot Blossom**

max. 10 W, G9  
230 V  
⌀128 ⇄74 ↗115 mm  
EAN 4000870 953457

**953.45 new**

- 🌀 White/Purple/Transparent 🗪 Metal/Glass
- 🌀 Blanco/Lila/Transparente 🗪 Metal/Cristal
- 🌀 Bianco/Lilla/Trasparente 🗪 Metallo/Vetro

💡 283.38  
284.46

A++-E

LED

**Spot Blossom**

max. 10 W, G9  
230 V  
⌀128 ⇄74 ↗115 mm  
EAN 4000870 953464

**953.46 new**

- 🌀 White/Transparent yellow 🗪 Metal/Glass
- 🌀 Blanco/Amarillo transparente 🗪 Metal/Cristal
- 🌀 Bianco/Giallo trasparente 🗪 Metallo/Vetro

💡 283.38  
284.46

A++-E

LED





W



W



W

**Pendulum Capsule II**

incl. 1x6 W  
420 lm, 2.700 K  
230 V  
⌀130 cm ø87 mm  
EAN 4000870 954584

**954.58 new**

- 🌀 White/Chrome 🗄 Metal
- 🌀 Blanco/Cromo 🗄 Metal
- 🌀 Bianco/Cromo 🗄 Metallo



**Pendulum Capsule**

incl. 1x4,5 W  
238 lm, 2.700 K  
230 V  
⌀130 cm ø87 mm  
EAN 4000870 952757

**952.75**

- 🌀 White/Chrome 🗄 Metal
- 🌀 Blanco/Cromo 🗄 Metal
- 🌀 Bianco/Cromo 🗄 Metallo



**Pendulum Sarrasani**

max. 40 W, GZ10 / GU10  
230 V  
⌀135 cm ø140 mm  
EAN 4000870 954904

**954.90 new**

- 🌀 White/Opal 🗄 Metal/Glass
- 🌀 Blanco/Opal 🗄 Metal/Cristal
- 🌀 Bianco/Opale 🗄 Metallo/Vetro

💡 282.86  
500.14  
500.15  
500.21



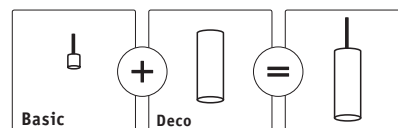

Deco □ = 148-149

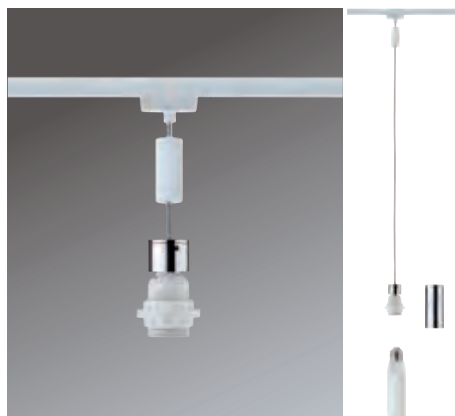

W

### 2Easy Basic Pendulum

max. 20 W, E27

230 V

±150 cm

EAN 4000870 954379

**954.37 new**

- 🌀 White/Chrome ☒ Metal
- 🌀 Blanco/Cromo ☒ Metal
- 🌀 Bianco/Cromo ☒ Metallo

💡 283.28  
500.11  
500.12  
500.13





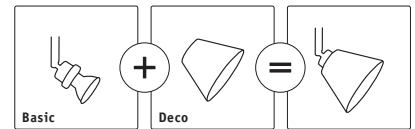
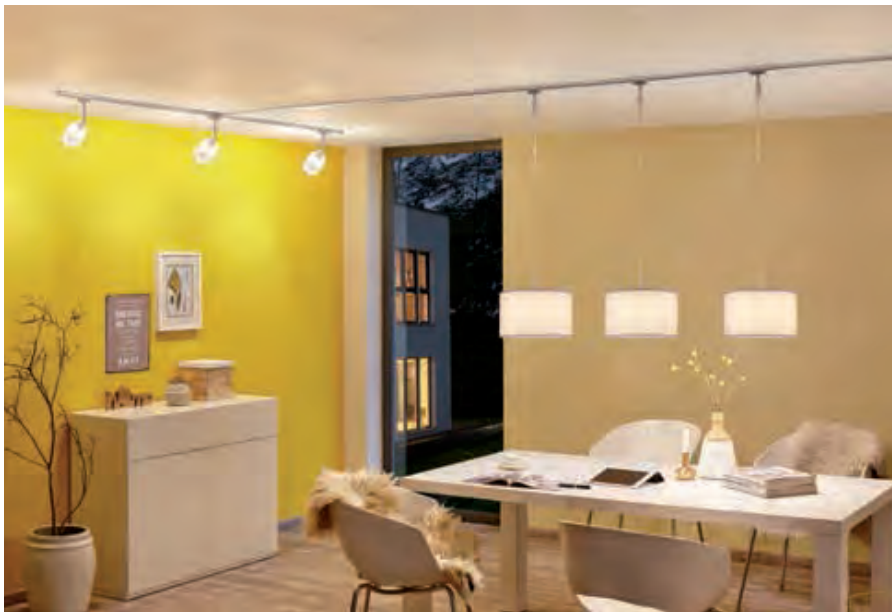

Deco □ = 150-152

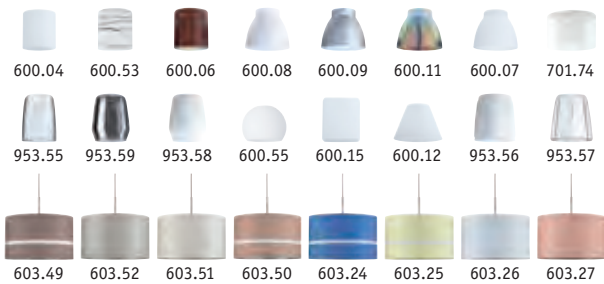

### Basic-Spot

incl. 1x3,5W, GZ10,  $A^{++}$   
 250 lm, 2.700 K  
 230 V  
 ⌀125 ⌀51 ⌀50 mm  
 EAN 4000870 951866  
**951.86**

🌀 White □ Metal  
 🌀 Blanco □ Metal  
 🌀 Bianco □ Metallo

💡 281.87  
 500.14  
 500.15  
 500.21

A<sup>++</sup>-E



### Basic-Pendulum

incl. 1x3,5W, GZ10,  $A^{++}$   
 250 lm, 2.700 K  
 230 V  
 ⌀135 cm  
 EAN 4000870 951859  
**951.85**

🌀 White □ Metal  
 🌀 Blanco □ Metal  
 🌀 Bianco □ Metallo

💡 281.87  
 500.14  
 500.15  
 500.21

A<sup>++</sup>-E





**CM**

- ☞ Chrome matt
- ☞ Cromo mate
- ☞ Cromo opaco



**W**

- ☞ White
- ☞ Blanco
- ☞ Bianco

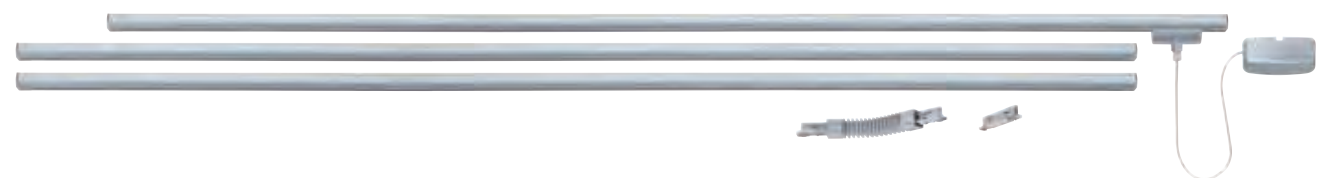
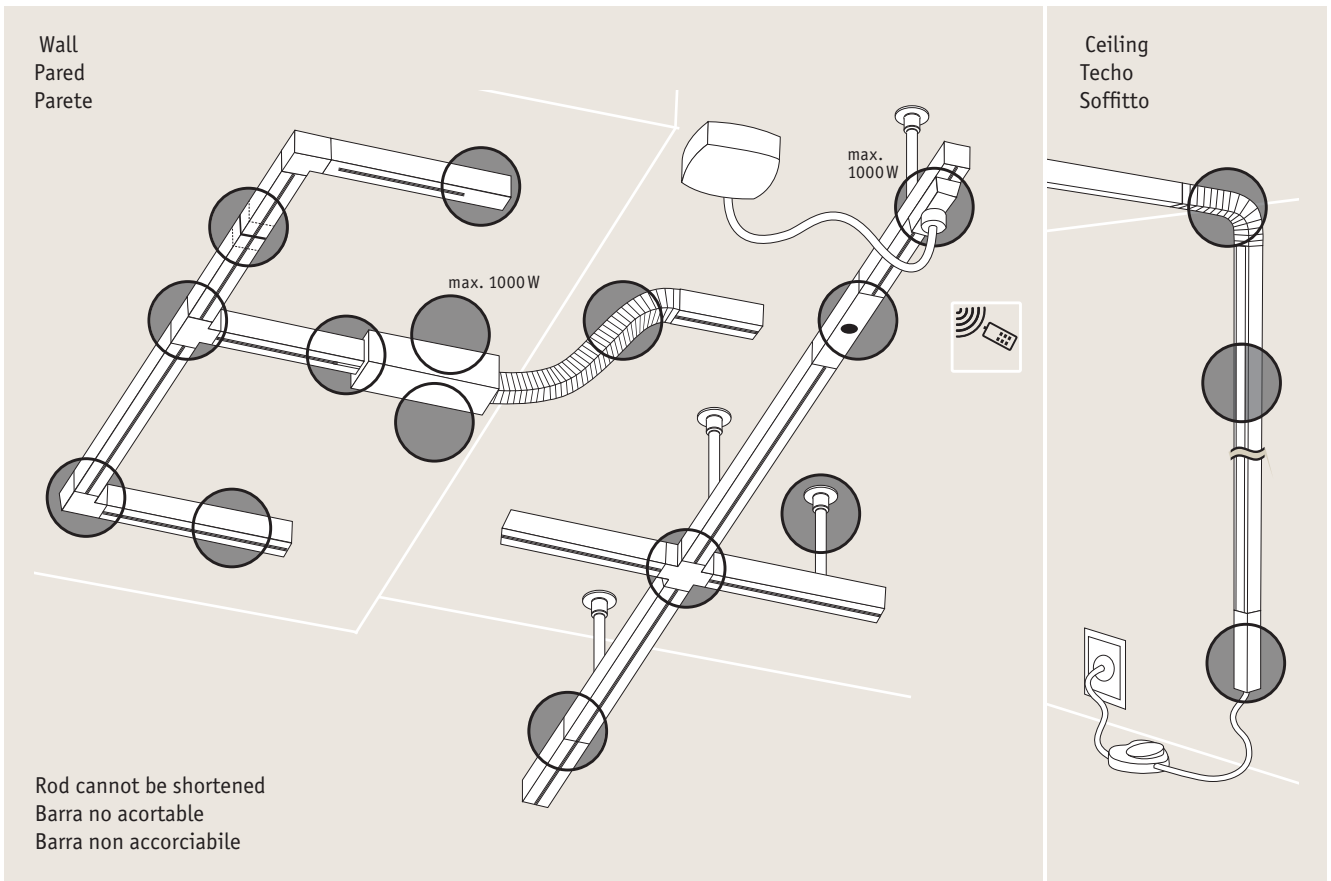

**URail Basicsystem**  
**Sistema de base URail**  
**Sistema base URail**

max. 1.000 W  
⇔3,1 m

**CM**

EAN 4000870 950166  
**950.16**

**W**

EAN 4000870 950173  
**950.17**



**Starter Set Allround Pendant Basic**

max. 20 W  
 ⇄ 1,2 m

**CM**

EAN 4000870 954645

**954.64 new**

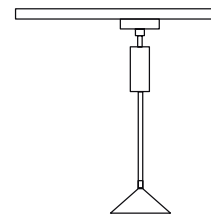

max. 1,5 kg

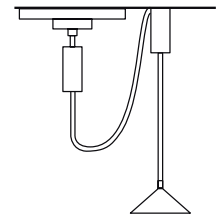

max. 3 kg



**Universal Pendant Adapter**

⇄ 106 ø62 mm

**CM**

EAN 4000870 954942

**954.94 new**

**W**

EAN 4000870 954959

**954.95 new**

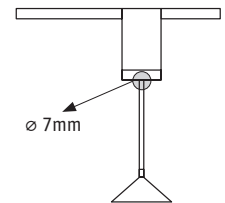

max. 3 kg



**Flex Pendant Adapter**  
 Adaptador para colgante Flex  
 Adattatore flessibile per sospensione

⇄ 154 ø22 mm

**CM**

EAN 4000870 951989

**951.98 new**

**W**

EAN 4000870 951996

**951.99 new**

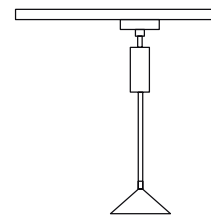

max. 1,5 kg

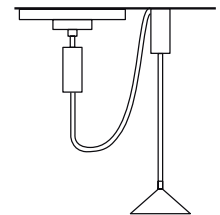

max. 3 kg



**Pendant adapter, can be shortened**  
 Adaptadores para péndulos, recortables  
 Adattatore accorciabile per lampadario

⇄ 135 ø26 mm

**CM**

EAN 4000870 974742

**974.74**

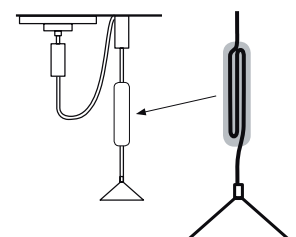



**Suspension**  
**Suspensión**  
**Sospensione**

CM

EAN 4000870 975992  
**975.99**

W

EAN 4000870 976883  
**976.88**

∅105 ∅23 mm

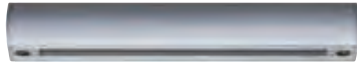

**Track**  
**Riel**  
**Binari**

max. 1.000 W  
∅18 mm ∅18 m

CM

∅0,1 m  
EAN 4000870 950869  
**950.86**

W

∅0,1 m  
EAN 4000870 954980  
**954.98** **new**



CM

∅0,5 m  
EAN 4000870 968543  
**968.54**

W

∅0,5 m  
EAN 4000870 976821  
**976.82**



CM

∅1 m  
EAN 4000870 968338  
**968.33**

W

∅1 m  
EAN 4000870 976838  
**976.83**



CM

∅2 m  
EAN 4000870 968345  
**968.34**

W

∅2 m  
EAN 4000870 976845  
**976.84**



**Safety Cover strip**

∅10 mm ∅0,7 m

CM

EAN 4000870 951262  
**951.26**

W

EAN 4000870 951262  
**951.26**



**Line Connector**  
**Conector lineal**  
**Connettore lineare**

max. 1.000 W  
∅15 ∅70 ∅11 mm

CM

EAN 4000870 951361  
**951.36**

W

EAN 4000870 951361  
**951.36**



36 mm

**X-Connector**  
**X-Conector**  
**X-Connettore**

max. 1.000 W  
∅18 ∅104 ∅104 mm

CM

EAN 4000870 976579  
**976.57**

W

EAN 4000870 976876  
**976.87**



36 mm

**T-Connector**  
**T-Conector**  
**T-Connettore**

max. 1.000 W  
∅18 ∅104 ∅62 mm

CM

EAN 4000870 976562  
**976.56**

W

EAN 4000870 976869  
**976.86**



29 mm

**L-Connector**  
**L-Conector**  
**L-Connettore**

max. 1.000 W  
∅18 ∅62 ∅62 mm

CM

EAN 4000870 976487  
**976.48**

W

EAN 4000870 976494  
**976.49**

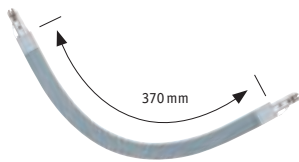

**Maxiflex Connector**  
**Conector Maxiflex**  
**Connettore Maxiflex**  
 max. 1.000 W  
 ⌀18 ⇄440 ↗18 mm

CM

EAN 4000870 953273  
**953.27** new

W

EAN 4000870 953280  
**953.28** new

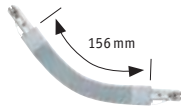

**Flex Connector II**  
**Conector flexible II**  
**Connettore flessibile II**  
 max. 1.000 W  
 ⌀18 ⇄227 ↗18 mm

CM

EAN 4000870 953259  
**953.25** new

W

EAN 4000870 953266  
**953.26** new

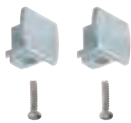

**Universal Endcap 2-Pack**  
 ⌀18 ⇄13 ↗21 mm

CM

EAN 4000870 954966  
**954.96** new

W

EAN 4000870 954973  
**954.97** new

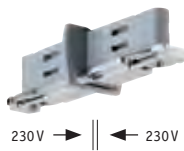

**Power isolating link**  
**Divisor de corriente**  
**Sezionatore**  
 ⌀18 ⇄70 ↗18 mm

CM

EAN 4000870 951408  
**951.40**

W



**Terminal feed**  
**Alimentación por un extremo**  
**Allimentazione finale**  
 max. 1.000 W  
 ⌀18 ⇄161 ↗18 mm

CM

EAN 4000870 976555  
**976.55**

W

EAN 4000870 976852  
**976.85**



**Middle/terminal feed**  
**Alimentación central / por un extremo**  
**Allimentazione centrale / finale**  
 max. 1.000 W  
 ⌀27 ⇄205 ↗45 mm

CM

EAN 4000870 968857  
**968.85**

W

EAN 4000870 968864  
**968.86**



**Middle/terminal feed**  
**Alimentación central / por un extremo**  
**Allimentazione centrale / finale**  
 max. 1.000 W  
 ⌀30 mm ⌀75 mm ⇄165 mm ⇄1 m

CM

EAN 4000870 968314  
**968.31**

W

EAN 4000870 976791  
**976.79**





### IR Rail switch remote control Mando a distancia IR Rail-Switch Telecomando IR Rail-Switch

CM

EAN 4000870 950739

950.73

⇅7 ⇄40 ↻85 mm

- ▶ Remote control for ease and convenience when switching or dimming URail systems.
- ▶ The receiver integrated in an adapter controls all of the subsequent sections of the system.
- ▶ The four function buttons on the remote control can be used to control two separate switches and two dimming processes.
- ▶ Mando a distancia para encender/apagar o regular cómodamente sistemas URail.
- ▶ El receptor integrado en un conector gobierna todas las subsiguientes secciones del sistema.
- ▶ Con las cuatro teclas de función del mando a distancia pueden controlarse 2 procesos de regulación o 2 circuitos separados.
- ▶ Telecomando per accendere, spegnere o variare comodamente l'intensità degli URail System.
- ▶ L'apparecchio ricevente, integrato in un elemento di connessione, comanda tutti i successivi segmenti del sistema.
- ▶ Tramite i quattro pulsanti del telecomando è possibile comandare due interruttori di accensione/spegnimento separati oppure due processi di variazione dell'intensità.



### IR Rail-Switch

CM

EAN 4000870 976531

976.53

W

EAN 4000870 976548

976.54

max. 500 W  
⇅18 ⇄240 ↻18 mm

- ▶ Minimum load 3 W, suitable for LEDs
- ▶ Easy plug-in installation
- ▶ Switches and dims downstream sections
- ▶ Carga mínima 3W apta para LED
- ▶ Fácil montaje mediante conectores enchufables
- ▶ Conmuta y regula las secciones posteriores
- ▶ Carico minimo 3W idoneo per LED
- ▶ Semplice montaggio a inserimento
- ▶ Commutazione e dimming delle seguenti sezioni



### Wireless Adapter

CM

EAN 4000870 952948

952.94

W

EAN 4000870 952955

952.95

max. 50 W  
⇅50 ⇄166 ↻19 mm



### Remote for Wireless Adapter

CM

EAN 4000870 952962

952.96

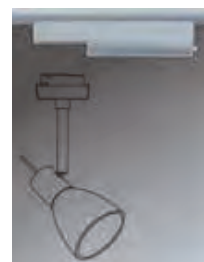

- ▶ Allows single heads and group switching functions to be controlled to switch between different lighting scenarios (as with a 2-phase rail system)
- ▶ All groups can be switched by remote control.
- ▶ Filigree look of the wireless electronics casing
- ▶ Max. 50 W per adapter, also suitable for halogen lamps
- ▶ Permite controlar cabezales individuales y grupos interconectados, de manera que se pueden controlar diferentes escenarios de iluminación (como en un sistema de railes de dos fases)
- ▶ Posibilidad de controlar todos los grupos con mando a distancia.
- ▶ Carcasa estilizada para el sistema electrónico del control inalámbrico
- ▶ Máx. 50W por adaptador, también apropiado para luminarias halógenas
- ▶ Consente il comando di singoli apparecchi e di gruppi, pertanto è possibile creare diversi scenari luminosi (come per il sistema a binario bi-fase)
- ▶ Tutti i gruppi sono controllabili tramite telecomando
- ▶ Alloggiamento filigranato per l'elettronica radio
- ▶ Max. 50W per adattatore, idoneo anche per apparecchi alogeni



**Motion Sensor**

max. 500 W  
 ⚡34 ⚡235 ⚡56 mm

**CM**

EAN 4000870 953174  
**953.17**

**W**

EAN 4000870 953181  
**953.18**

- |  |  |  |
|--|--|--|
| <ul style="list-style-type: none"> <li>▶ On-time can be set between 1 and 30 mins.</li> <li>▶ Dusk sensor is infinitely adjustable</li> <li>▶ Premium-quality, detects even the smallest of movements and keeps the light on permanently</li> <li>▶ Power supply for URail for installation on ceiling or wall outlet</li> </ul> | <ul style="list-style-type: none"> <li>▶ Posibilidad de ajustar un tiempo de conexión de 1-30 minutos</li> <li>▶ Sensor crepuscular regulable sin escalonados</li> <li>▶ Detecta incluso pequeños movimientos, dejando encendida la luz en permanencia</li> <li>▶ Alimentación para raíl URail para el montaje en la salida del techo o de la pared</li> </ul> | <ul style="list-style-type: none"> <li>▶ Durata di accensione di 1-30 min. regolabile</li> <li>▶ Sensore crepuscolare a regolazione continua</li> <li>▶ Pregiato, rileva anche piccoli movimenti e mantiene la luce accesa</li> <li>▶ Alimentazione per binari URail per montaggio su scarico soffitto o parete</li> </ul> |
|--|--|--|

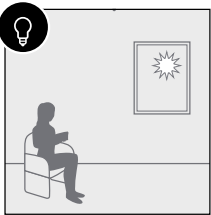

Dusk sensor – the light comes on as soon it gets dark outside

Sensor crepuscular: la luz no se enciende hasta que no anochece

Sensore crepuscolare: la luce viene accesa non appena fuori fa buio

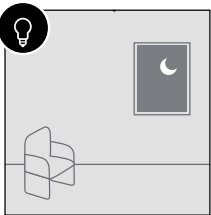

Saves energy – if no one is in the room, the light stays off

Ahorro de energía: si no hay nadie en la estancia, la luz permanece apagada

Risparmio energetico: se nell'ambiente interessato non vi è nessuno, la luce resta spenta

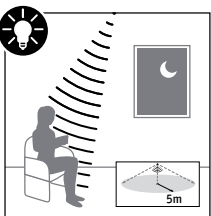

Even small movements are detected and keep the light on

La luz permanece encendida incluso con un movimiento mínimo

La luce rimane accesa anche in caso di movimenti minimi



**Smart Home** 📖 = 386-403

Comfortably control your lighting with your smart phone or remote control, using the additional products from the Smart Home chapter (P. 386-403).

Controle su luz cómodamente mediante el smartphone o el mando a distancia con los productos complementarios del capítulo Smart Home (p. 386-403)

Comandate le vostre luci comodamente utilizzando lo smartphone o il telecomando con i prodotti supplementari del capitolo Smart Home (pag. 386-403).

**Rail Switch**

max. 500 W  
 ⚡18 ⇄135 ⚡18 mm

**CM**

EAN 4000870 952825  
**952.82** 📦

**W**

EAN 4000870 953112  
**953.11** 📦



- ▶ The rail switch allows you to switch downstream wall sections on or off directly
- ▶ Easy plug-in installation

- ▶ El interruptor en el raíl ofrece la posibilidad de conectar o desconectar directamente las secciones de pared posteriores
- ▶ Fácil montaje mediante conectores enchufables

- ▶ Il commutatore binario offre la possibilità di accendere o spegnere direttamente le successive sezioni di parete
- ▶ Semplice montaggio a inserimento

**Terminal feed**  
**Alimentación por un extremo**  
**Allimentazione finale**

max. 1.000 W  
 ⚡18 mm ⇄18 mm ⇄2,4 m

**CM**

EAN 4000870 951255  
**951.25** 📦



**Terminal power connection can be shortened**  
**Alimentación por un extremo acortable**  
**Allimentazione finale accorciabile**

max. 1.000 W  
 ⇄50 mm ⇄0,6 m

**CM**

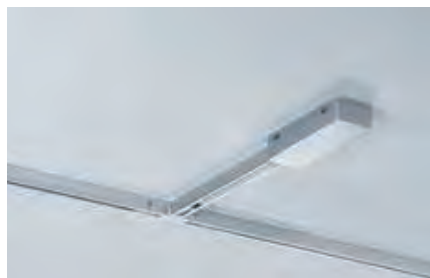
EAN 4000870 951248  
**951.24** 📦

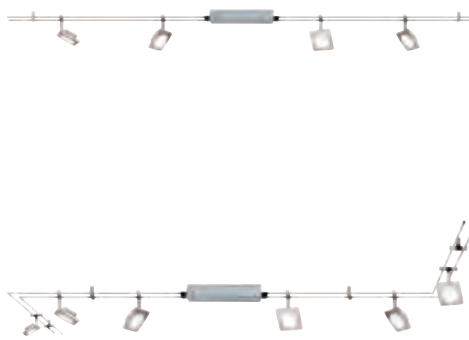



**QuadLED** A++-A  
 incl. 4x4 W LED  
 4x200 lm, 2.700 K □  
 230/12 V, incl. ⚡ 30 VA  
 ⚙ 30 mm ↔ 1,6 m  
 EAN 4000870 951927  
**951.92**

**QuadLED** A++-A  
 incl. 6x4 W LED  
 6x200 lm, 2.700 K □  
 230/12 V, incl. ⚡ 30 VA  
 ⚙ 30 mm ↔ 2,9 m  
 EAN 4000870 951934  
**951.93**

- 🌀 Chrome matt   Metal
- 🌀 Cromo mate   Metal
- 🌀 Cromo opaco   Metallo



- ☞ Chrome matt ☐ Metal
- ☞ Cromo mate ☐ Metal
- ☞ Cromo opaco ☐ Metallo

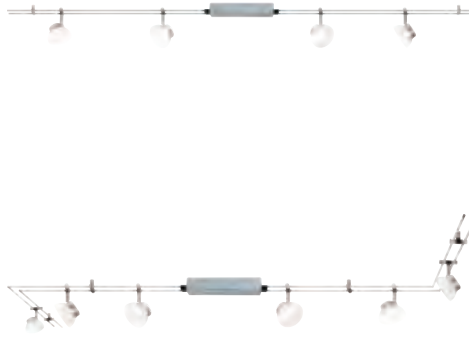

**IceLED I** A++-A

incl. 4×4 W LED

4×200 lm, 2.700 K

230/12 V, incl. ⚡ 30 VA ☐

⚡ 30 mm ↔ 1,6 m

EAN 4000870 951941

**951.94**

**IceLED I** A++-A

incl. 6×4 W LED

6×200 lm, 2.700 K

230/12 V, incl. ⚡ 30 VA ☐

⚡ 30 mm ↔ 3 m

EAN 4000870 951958

**951.95**



- ☞ Chrome matt ☐ Metal
- ☞ Cromo mate ☐ Metal
- ☞ Cromo opaco ☐ Metallo



**IceLED II** A++-A

incl. 4×4 W LED

4×200 lm, 2.700 K

230/12 V, incl. ⚡ 30 VA ☐

⚡ 30 mm ↔ 1,6 m

EAN 4000870 951965

**951.96**

**IceLED II** A++-A

incl. 6×4 W LED

6×200 lm, 2.700 K

230/12 V, incl. ⚡ 30 VA ☐

⚡ 30 mm ↔ 3 m

EAN 4000870 951972

**951.97**



- ☞ White/Chrome ☐ Metal/Glass
- ☞ Blanco/Cromo ☐ Metal/Cristal
- ☞ Bianco/Cromo ☐ Metallo/Vetro



**Stage** A++-A

incl. 4×5 W LED

4×300 lm, 2.700 K

230 V, incl. ⚡ 30 VA ☐

⚡ 30 mm ↔ 2,1 m ☒

EAN 4000870 950777

**950.77**



# Function

- 175 MaxLED
- 189 YourLED
- 202 WaterLED
- 205 Specialstrips
- 210 SimpLED
- 212 Duo Profil
- 214 Delta Profil
- 216 Floor Profil
- 217 Corner Profil
- 218 Square, BackLight Profil
- 219 Step Profil
- 220 Cup Profil
- 221 Socle Profil
- 222 Deep Profil
- 223 Flying Strip
- 224 Cabinetlight



220 Cup Profil



219 Step Profil



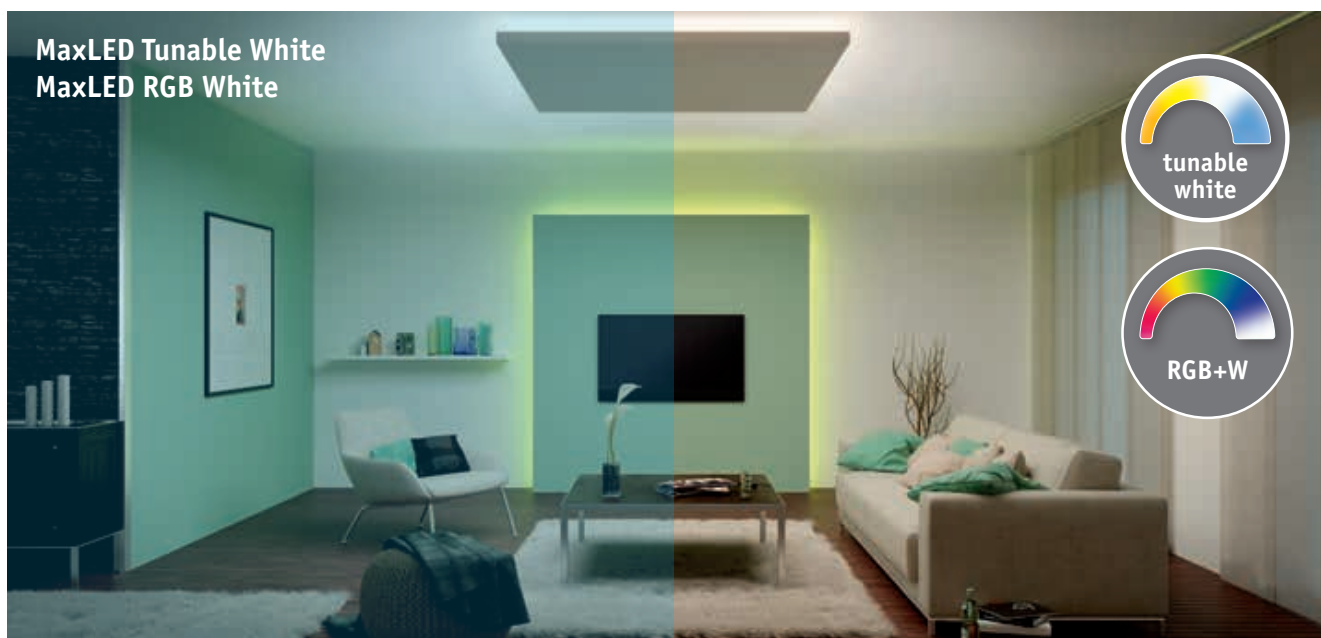
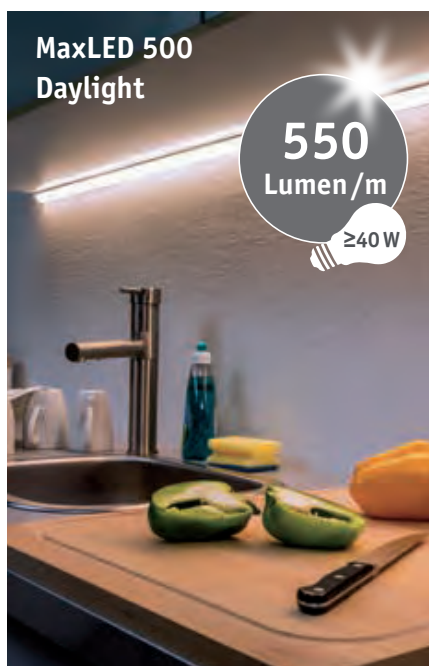

- ▶ With their powerful brightness, MaxLED LED strips open up completely new ideas for general room and work lighting
- ▶ Dense LED placement provides a continuous light pattern - ideal for use in profiles
- ▶ 1m MaxLED 1000 strip corresponds approximately to a 75 W incandescent bulb in terms of the lighting quality
- ▶ MaxLED is available in an expandable basic set of comfortable warm white - 2700 K, daylight white - 6500 K or as an RGB colour change system with remote control
- ▶ Light you can stick on: thanks to the adhesive strips on the reverse, it can be positioned quickly without tools
- ▶ Con su luminosidad, las regletas de LEDs MaxLED abren posibilidades novedosas para la luz del hogar y del trabajo
- ▶ Su alta densidad de LEDs crea un hilo continuo de luz: ideal para instalar en perfiles y molduras
- ▶ La regleta MaxLED 1000 de 1 m equivale al efecto lumínico de una bombilla incandescente de 75 W
- ▶ Los sets básicos ampliables de MaxLED se ofrecen en blanco cálido acogedor - 2700 K, luz blanca diurna - 6500 K o como luz de color cambiante RGB con mando a distancia
- ▶ Luces autoadherentes: gracias a la tira adhesiva de su reverso se tienden rápidamente sin necesidad de herramientas
- ▶ Grazie a un'elevata potenza luminosa, le strisce di LED MaxLED aprono scenari completamente nuovi per l'illuminazione generale di spazi abitativi e ambienti di lavoro
- ▶ L'alta concentrazione di LED garantisce una luce continua, ideale per l'integrazione in profilati
- ▶ Una striscia MaxLED 1000 da 1 m assicura un effetto luminoso comparabile a quello di una lampada a incandescenza da 75 W
- ▶ MaxLED è disponibile nei set di base ampliables in confortevole bianco caldo (2700 K), bianco naturale (6500 K) o con cambio di colore RGB tramite telecomando
- ▶ Luce incollabile: installazione rapida senza bisogno di attrezzi grazie alla striscia adesiva sul retro



- 🔗 Silver 🏠 Metal
- 🔗 Plateado 🏠 Metal
- 🔗 Argento 🏠 Metallo

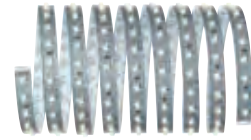

**Strip Warm white 50cm**

A++-A

incl. 1x3,5W  
280 lm, 2.700 K  
DC 24 V  
⌀3 ⇔500 ⌀12,5 mm  
EAN 4000870 705834  
**705.83** 📦



**Strip Warm white 1m**

A++-A

incl. 1x7 W  
550 lm, 2.700 K  
DC 24 V  
⌀3 mm ⌀12,5 mm ⇔1 m  
EAN 4000870 705810  
**705.81** 📦



**Strip Warm white 2,5m**

A++-A

incl. 1x16 W  
1.375 lm, 2.700 K  
24 V  
⌀3 mm ⌀12,5 mm ⇔2,5 m  
EAN 4000870 708279  
**708.27** 📦 **new**

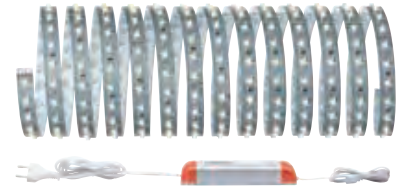
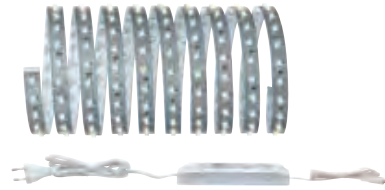

**Basic Set Warm white 1,5m expanded max. 3m**

A++-A

incl. 1x10 W  
825 lm, 2.700 K  
230/24 V, incl. ⚡ 20 VA  
⌀3 mm ⌀12,5 mm ⇔1,5 m  
EAN 4000870 705773  
**705.77** 📦



**Basic Set Warm white 3m expanded 5,4 m**

A++-A

incl. 1x20 W  
1.650 lm, 2.700 K  
230/24 V, incl. ⚡ 36 VA  
⌀3 mm ⌀12,5 mm ⇔3 m  
EAN 4000870 705797  
**705.79** 📦



**Basic Set Warm white 5m expanded max. 10m**

A++-A

incl. 1x33 W  
2.750 lm, 2.700 K  
230/24 V, incl. ⚡ 75 VA  
⌀3 mm ⌀12,5 mm ⇔5 m  
EAN 4000870 706046  
**706.04** 📦

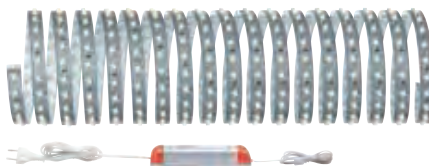

**MaxLED Basic Sets**

A++-A

incl. 1x53,5 W  
5.500 lm, 2.700 K  
230/24 V, incl. ⚡ 80 VA  
⌀3 mm ⌀12,5 mm ⇔10 m  
EAN 4000870 708293  
**708.29** 📦 **new**







MaxLED 500

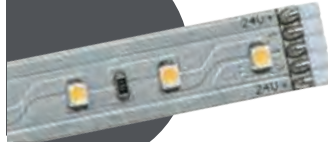

- 🔗 Silver Metal
- 🔗 Plateado Metal
- 🔗 Argento Metallo

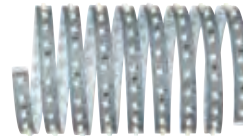

**Strip Daylight 50cm**

incl. 1x3 W  
280 lm, 6.500 K  
DC 24 V  
⌀3 ⇄500 ↗12,5 mm  
EAN 4000870 705841  
**705.84**



**Strip Daylight 1m**

incl. 1x6 W  
550 lm, 6.500 K  
DC 24 V  
⌀3 mm ↗12,5 mm ⇄1 m  
EAN 4000870 705827  
**705.82**



**Strip Daylight 2,5m**

incl. 1x14 W  
1.375 lm, 6.500 K  
24 V  
⌀3 mm ↗12,5 mm ⇄2,5 m  
EAN 4000870 708286  
**708.28** **new**

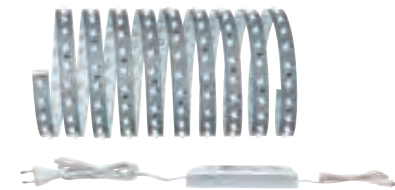
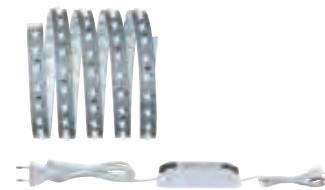

**Basic Set Daylight 1,5m expanded 3,4 m**

incl. 1x8,5 W  
825 lm, 6.500 K  
230/24 V, incl. 20 VA  
⌀3 mm ↗12,5 mm ⇄1,5 m  
EAN 4000870 705780  
**705.78**



**Basic Set Daylight 3m expanded 6,2 m**

incl. 1x17 W  
1.650 lm, 6.500 K  
230/24 V, incl. 36 VA  
⌀3 mm ↗12,5 mm ⇄3 m  
EAN 4000870 705803  
**705.80**



**Basic Set Daylight 5m expanded max. 10m**

incl. 1x28 W  
2.750 lm, 6.500 K  
230/24 V, incl. 60 VA  
⌀3 mm ↗12,5 mm ⇄5 m  
EAN 4000870 706053  
**706.05**

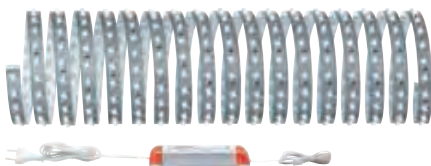

**MaxLED Basic Sets**

incl. 1x48,5 W  
5.500 lm, 6.500 K  
230/24 V, incl. 75 VA  
⌀3 mm ↗12,5 mm ⇄10 m  
EAN 4000870 708309  
**708.30** **new**



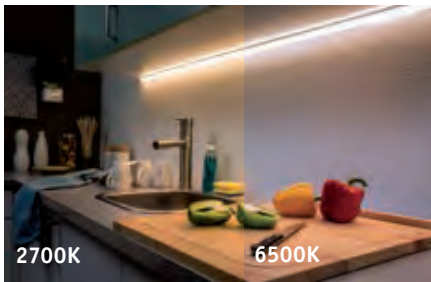

MaxLED 500



- 🔗 Silver 🏠 Plástico
- 🔗 Plateado 🏠 Plástico
- 🔗 Argento 🏠 Plastica



**Strip Warm white 50cm**

A++-A

incl. 1x3,5 W  
280 lm, 2.700 K  
DC 24 V  
⌀4 ⇄500 ⇄12,5 mm  
EAN 4000870 706619  
**706.61**

LED



**Strip Warm white 1m**

A++-A

incl. 1x7 W  
550 lm, 2.700 K  
DC 24 V  
⌀4 mm ⇄12,5 mm ⇄1 m  
EAN 4000870 706633  
**706.63**

LED



**Basic Set Warm white 1,5m expanded max. 3m**

A++-A

incl. 1x10 W  
825 lm, 2.700 K  
230/24 V, incl. ⚡ 20 VA  
⌀4 mm ⇄12,5 mm ⇄1,5 m  
EAN 4000870 706688  
**706.68**

LED



**Basic Set Warm white 3m expanded 5,4 m**

A++-A

incl. 1x20 W  
1.650 lm, 2.700 K  
230/24 V, incl. ⚡ 36 VA  
⌀4 mm ⇄12,5 mm ⇄3 m  
EAN 4000870 706664  
**706.66**

LED



**Strip Daylight 50cm**

A++-A

incl. 1x3 W  
280 lm, 6.500 K  
DC 24 V  
⌀4 ⇄500 ⇄12,5 mm  
EAN 4000870 706626  
**706.62**

LED



**Strip Daylight 1m**

A++-A

incl. 1x6 W  
550 lm, 6.500 K  
DC 24 V  
⌀4 mm ⇄12,5 mm ⇄1 m  
EAN 4000870 706640  
**706.64**

LED



**Basic Set Daylight 1,5m expanded 3,4 m**

A++-A

incl. 1x8,5 W  
825 lm, 6.500 K  
230/24 V, incl. ⚡ 20 VA  
⌀4 mm ⇄12,5 mm ⇄1,5 m  
EAN 4000870 706671  
**706.67**

LED



**Basic Set Daylight 3m expanded 6,2 m**

A++-A

incl. 1x17 W  
1.650 lm, 6.500 K  
230/24 V, incl. ⚡ 36 VA  
⌀4 mm ⇄12,5 mm ⇄3 m  
EAN 4000870 706657  
**706.65**

LED





MaxLED 500



- 🔗 Silver 🏠 Plástico
- 🔗 Plateado 🏠 Plástico
- 🔗 Argento 🏠 Plastica



**Basic Set Warm white 1,5m**  
**expanded max. 3m Dimm/**  
**Switch Controller IR**

A++-A

incl. 1x10 W  
 825 lm, 2.700 K  
 230/24 V, incl. -⚡ 20 VA  
 ⌀4 mm ⚡12,5 mm ↔1,5 m  
 EAN 4000870 708026  
**708.02** 📦 **new**



**Basic Set Warm white**  
**3m expanded max. 5,4m**  
**Dimm/Switch Controller IR**

A++-A

incl. 1x20 W  
 1.650 lm, 2.700 K  
 230/24 V, incl. -⚡ 36 VA  
 ⌀4 mm ⚡12,5 mm ↔3 m  
 EAN 4000870 708033  
**708.03** 📦 **new**





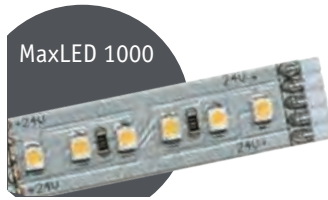
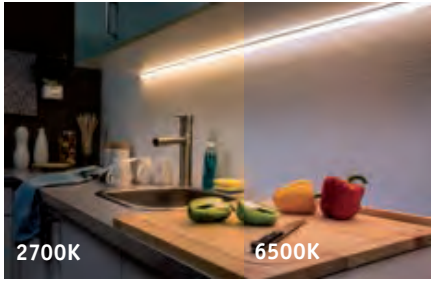

- 🔗 Silver Metal
- 🔗 Plateado Metal
- 🔗 Argento Metallo



**Strip Warm white 50cm**

incl. 1x7W  
550 lm, 2.700 K  
DC 24 V  
⌀3 mm ⌀12,5 mm ↔0,5 m  
EAN 4000870 705711  
**705.71**



**Strip Warm white 1m**

incl. 1x13,5W  
1.100 lm, 2.700 K  
DC 24 V  
⌀3 mm ⌀12,5 mm ↔1 m  
EAN 4000870 705681  
**705.68**



**Basic Set Warm white 1,5m expanded max. 4,2m**

incl. 1x20W  
1.650 lm, 2.700 K  
230/24V, incl. 60 VA  
⌀3 mm ⌀12,5 mm ↔1,5 m  
EAN 4000870 705858  
**705.85**



**Basic Set Warm white 3m expanded max. 5,3m**

incl. 1x40W  
3.300 lm, 2.700 K  
230/24V, incl. 75 VA  
⌀3 mm ⌀12,5 mm ↔3 m  
EAN 4000870 705889  
**705.88**



**Strip Daylight 50cm**

incl. 1x6W  
550 lm, 6.500 K  
DC 24 V  
⌀3 mm ⌀12,5 mm ↔0,5 m  
EAN 4000870 705728  
**705.72**



**Strip Daylight 1m**

incl. 1x11,5W  
1.100 lm, 6.500 K  
DC 24 V  
⌀3 mm ⌀12,5 mm ↔1 m  
EAN 4000870 705698  
**705.69**



**Basic Set Daylight 1,5m expanded max. 3,1m**

incl. 1x17 W  
1.650 lm, 6.500 K  
230/24V, incl. 36 VA  
⌀3 mm ⌀12,5 mm ↔1,5 m  
EAN 4000870 705865  
**705.86**



**Basic Set Daylight 3m expanded max. 5,2m**

incl. 1x34W  
3.300 lm, 6.500 K  
230/24V, incl. 60 VA  
⌀3 mm ⌀12,5 mm ↔3 m  
EAN 4000870 705896  
**705.89**



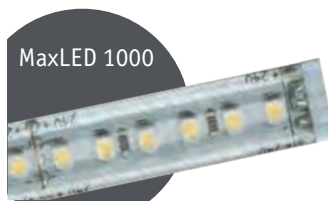





- 🔗 Silver 📦 Plastic
- 🔗 Plateado 📦 Plástico
- 🔗 Argentó 📦 Plástica



**Strip Warm white 50cm** A++-A

incl. 1x7W  
550lm, 2.700K  
DC 24V  
⌀4 ⇄500 ⇄12,5 mm  
EAN 4000870 706596  
**706.59** 📦





  
  
  





  
  
  



**Strip Warm white 1m** A++-A

incl. 1x13,5W  
1.100lm, 2.700K  
DC 24V  
⌀4 mm ⇄12,5 mm ⇄1 m  
EAN 4000870 706763  
**706.76** 📦





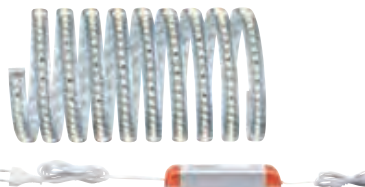







  
  
  



**Basic Set Warm white 1,5m expanded max. 4,2m** A++-A





incl. 1x20W  
1.650lm, 2.700K  
230/24V, incl. ⚡ 60VA  
⌀4 mm ⇄12,5 mm ⇄1,5 m  
EAN 4000870 706725  
**706.72** 📦





  
  
  
  

**Basic Set Warm white 3m expanded max. 5,3m** A++-A

incl. 1x40W  
3.300lm, 2.700K  
230/24V, incl. ⚡ 75VA  
⌀4 mm ⇄12,5 mm ⇄3 m  
EAN 4000870 706701  
**706.70** 📦



**Strip Daylight 50cm** A++-A

incl. 1x6W  
550lm, 6.500K  
DC 24V  
⌀4 ⇄500 ⇄12,5 mm  
EAN 4000870 706602  
**706.60** 📦





  
  
  





  
  
  



**Strip Daylight 1m** A++-A

incl. 1x11,5W  
1.100lm, 6.500K  
DC 24V  
⌀4 mm ⇄12,5 mm ⇄1 m  
EAN 4000870 706756  
**706.75** 📦





  
  
  







  
  
  



**Basic Set Daylight 1,5m expanded max. 3,1m** A++-A





incl. 1x17W  
1.650lm, 6.500K  
230/24V, incl. ⚡ 36VA  
⌀4 mm ⇄12,5 mm ⇄1,5 m  
EAN 4000870 706718  
**706.71** 📦





  
  
  
  

**Basic Set Daylight 3m expanded max. 5,2m** A++-A

incl. 1x34W  
3.300lm, 6.500K  
230/24V, incl. ⚡ 60VA  
⌀4 mm ⇄12,5 mm ⇄3 m  
EAN 4000870 706695  
**706.69** 📦

  
  
  
  



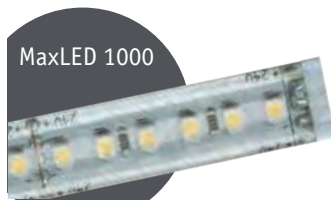

- 🔗 Silver 📦 Plastic
- 🔗 Plateado 📦 Plástico
- 🔗 Argento 📦 Plastica

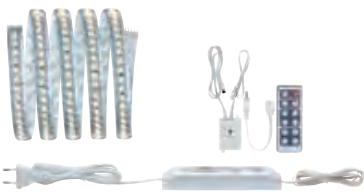

**Basic Set Warm white**  
**1,5m expanded max. 4,2m**  
**Dimm/Switch Controller IR**

A++-A

incl. 1x20W  
 1.650lm, 2.700K  
 230/24V, incl. ⚡ 60VA  
 ⌀4 mm ⌀12,5mm ⇄1,5 m  
 EAN 4000870 708002  
**708.00** 📦 **new**



**Basic Set Warm white**  
**3m expanded max. 5,3m**  
**Dimm/Switch Controller IR**

A++-A

incl. 1x40W  
 3.300lm, 2.700K  
 230/24V, incl. ⚡ 75VA  
 ⌀4 mm ⌀12,5mm ⇄3 m  
 EAN 4000870 708019  
**708.01** 📦 **new**



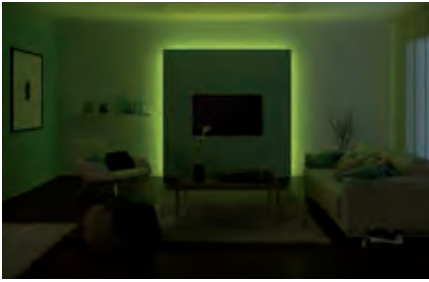

MaxLED RGB



- 🌀 Silver 📊 Metal
- 🌀 Plateado 📊 Metal
- 🌀 Argento 📊 Metallo



**Strip RGB 50cm**

A++-A

incl. 1x7W  
Deco  
DC 24V  
⌀3 mm ⌀12,5 mm ⇔0,5 m  
EAN 4000870 705735  
**705.73** 📦

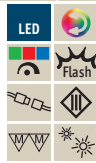

**Strip RGB 1m**

A++-A

incl. 1x13,5W  
Deco  
DC 24V  
⌀3 mm ⌀12,5 mm ⇔1 m  
EAN 4000870 705704  
**705.70** 📦

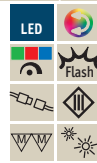

**Basic Set RGB 1,5m expanded max. 3m**

A++-A

incl. 1x20W  
Deco  
230/24V, incl. 📦 36VA  
⌀3 mm ⌀12,5 mm ⇔1,5 m  
EAN 4000870 705872  
**705.87** 📦



**Basic Set RGB 3m expanded max. 5m**

A++-A

incl. 1x40W  
Deco  
230/24V, incl. 📦 60VA  
⌀3 mm ⌀12,5 mm ⇔3 m  
EAN 4000870 705674  
**705.67** 📦

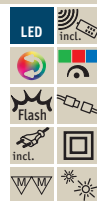

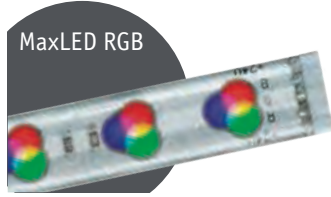
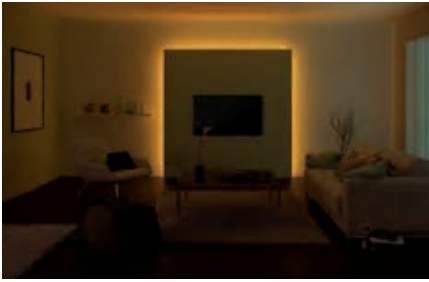

- 🔗 Silver 📦 Plástico
- 🔗 Plateado 📦 Plástico
- 🔗 Argento 📦 Plastica



**Strip RGB 50cm**

A++-A

incl. 1x7W  
Deco  
DC 24V  
⌀4 mm ⌀12,5 mm ↔0,5 m  
EAN 4000870 706589  
**706.58** 📦

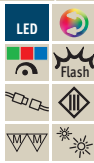

**Strip RGB 1m**

A++-A

incl. 1x13,5W  
Deco  
DC 24V  
⌀4 mm ⌀12,5 mm ↔1 m  
EAN 4000870 706572  
**706.57** 📦

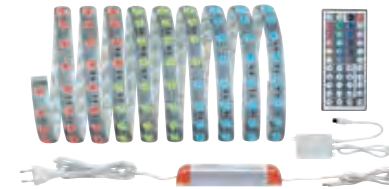
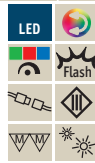

**Basic Set RGB 1,5m expanded max. 3m**

A++-A

incl. 1x20W  
Deco  
230/24V, incl. ⚡ 36VA  
⌀4 mm ⌀12,5 mm ↔1,5 m  
EAN 4000870 706749  
**706.74** 📦



**Basic Set RGB 3m expanded max. 5m**

A++-A

incl. 1x40W  
Deco  
230/24V, incl. ⚡ 60VA  
⌀4 mm ⌀12,5 mm ↔3 m  
EAN 4000870 706732  
**706.73** 📦

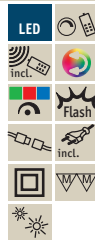



MaxLED 500  
Tunable White



- 🔗 Silver 📦 Plastic
- 🔗 Plateado 📦 Plástico
- 🔗 Argento 📦 Plastica



**Strip 50cm Tunable White**

A++-A

incl. 1x3,5 W  
275-290 lm, 2.700 - 6.500 K  
✗ 120°  
DC 24 V  
⌀3 mm ⌀12,5 mm ⇄0,5 m  
EAN 4000870 706299  
**706.29** 📦



**Strip 1m Tunable White**

A++-A

incl. 1x7 W  
550-580 lm, 2.700 - 6.500 K  
✗ 120°  
DC 24 V  
⌀3 mm ⌀12,5 mm ⇄1 m  
EAN 4000870 706305  
**706.30** 📦



**Basic Set 1,5m Tunable White - max. exp. 3m**

A++-A

incl. 1x10 W  
2.700 - 6.500 K  
✗ 120°  
230/24 V, incl. - 20 VA  
⌀3 mm ⌀12,5 mm ⇄1,5 m  
EAN 4000870 706237  
**706.23** 📦



**Basic Set 3m Tunable White - max. exp. 5m**

A++-A

incl. 1x20 W  
1.650-1.740 lm, 2.700 - 6.500 K  
✗ 120°  
230/24 V, incl. - 36 VA  
⌀3 mm ⌀12,5 mm ⇄3 m  
EAN 4000870 706244  
**706.24** 📦





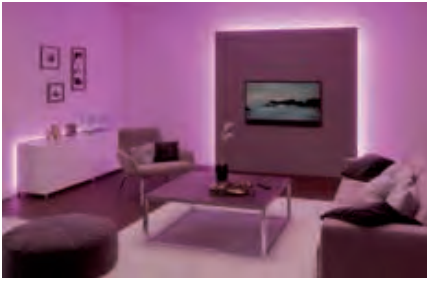

- 🔗 Silver 📦 Plástico
- 🔗 Plateado 📦 Plástico
- 🔗 Argentó 📦 Plástica

MaxLED  
RGB White



**Strip 50cm RGBW**

A++-A

incl. 1x6 W  
193+210 lm, 2.700 K  
✗ 120°  
DC 24 V  
⌀3 mm ⌀12,5 mm ⇔0,5 m  
EAN 4000870 706336



**706.33** 📦

**Strip 1m RGBW**

A++-A

incl. 1x12 W  
2.700 K  
✗ 120°  
DC 24 V  
⌀3 mm ⌀12,5 mm ⇔1 m  
EAN 4000870 706343

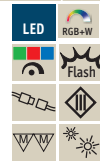

**706.34** 📦

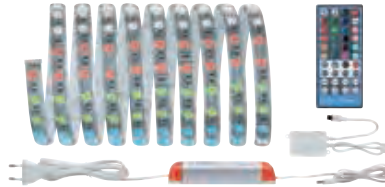

**Basic Set 1,5m RGBW - max. exp. 3m**

A++-A

incl. 1x18 W  
580+630 lm, 2.700 K  
✗ 120°  
230/24 V, incl. ⚡ 36 VA  
⌀3 mm ⌀12,5 mm ⇔1,5 m  
EAN 4000870 706275



**706.27** 📦

**Basic Set 3m RGBW - max. exp. 5m**

A++-A

incl. 1x36 W  
1.160+1.260 lm, 2.700 K  
✗ 120°  
230/24 V, incl. ⚡ 60 VA  
⌀3 mm ⌀12,5 mm ⇔3 m  
EAN 4000870 706282



**706.28** 📦

- 🌀 White 📦 Plastic
- 🌀 Blanco 📦 Plástico
- 🌀 Bianco 📦 Plastica



$\updownarrow$ 6  $\leftrightarrow$ 100  $\nearrow$ 15 mm  
 EAN 4000870 705766  
**705.76** 📦



$\updownarrow$ 6 mm  $\nearrow$ 15 mm  $\leftrightarrow$ 1 m  
 EAN 4000870 705759  
**705.75** 📦

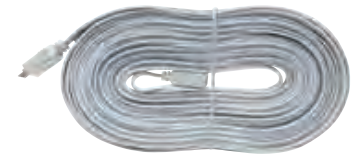

**Flex-Connector 5m**  
 $\updownarrow$ 6 mm  $\nearrow$ 15 mm  $\leftrightarrow$ 5 m  
 EAN 4000870 705742  
**705.74** 📦

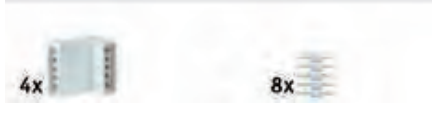

**MaxLED Edge-Connector**  
 max. 144 W  
 $\updownarrow$ 12  $\leftrightarrow$ 17  $\nearrow$ 16 mm  
 EAN 4000870 706152  
**706.15** 📦

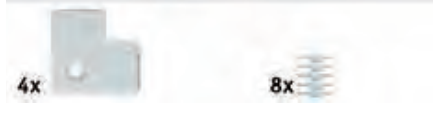

**MaxLED Edge-Connector 90°**  
 max. 144 W  
 $\updownarrow$ 4,5  $\leftrightarrow$ 25  $\nearrow$ 25 mm  
 EAN 4000870 706169  
**706.16** 📦



**MaxLED X-Connector**  
 max. 144 W  
 $\updownarrow$ 6  $\leftrightarrow$ 32  $\nearrow$ 28 mm  
 EAN 4000870 706176  
**706.17** 📦



**MaxLED Clip-to-Clip Connector**  
 max. 144 W  
 $\updownarrow$ 4,5  $\leftrightarrow$ 20  $\nearrow$ 13,5 mm  
 EAN 4000870 706183  
**706.18** 📦



**Power Supply 230/24V DC**  
 max. 36 W  
 230/24 V, incl.  $\boxminus$  36 VA  
 $\updownarrow$ 24  $\leftrightarrow$ 166  $\nearrow$ 52 mm  
 EAN 4000870 708231  
**708.23** 📦 **new**



**Power Supply 230/24V DC**  
 max. 60 W  
 230/24 V, incl.  $\boxminus$  60 VA  
 $\updownarrow$ 35  $\leftrightarrow$ 175  $\nearrow$ 54 mm  
 EAN 4000870 708248  
**708.24** 📦 **new**

- ▶ For switching or dimming individual MaxLED strips
- ▶ Remote control also in practical 2.4 GHz wireless design

- ▶ Para la conmutación o regulación de MaxLED Strips individuales
- ▶ Mando a distancia también como práctica versión inalámbrica 2,4 GHz

- ▶ Per commutare o dimmerare singole strisce MaxLED
- ▶ Telecomando anche in pratica versione radio 2,4 GHz

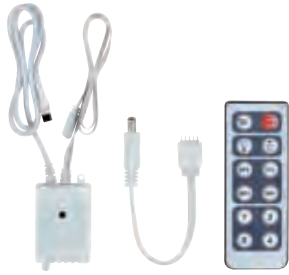

**Dimm/Switch Controller IR**

max. 144 W  
 CR 2025 x 1  
 DC 24 V  
 ⌀22 ⇄50 ⌀35 mm  
 EAN 4000870 706831  
**706.83**



**Dimm/Switch-Controller 2.4GHz**

max. 144 W  
 AAA/1,5V (Micro) x 2  
 DC 24 V  
 ⌀22,5 ⇄85 ⌀45 mm  
 EAN 4000870 706190  
**706.19**



**RGB-Controller 2,4GHz**

max. 144 W  
 AAA/1,5V (Micro) x 2  
 DC 24 V  
 ⌀22,5 ⇄85 ⌀45 mm  
 EAN 4000870 706213  
**706.21**



- ▶ Amplifying the control signal from the MaxLED Controller

- ▶ Para amplificar la señal de control de la controladora MaxLED

- ▶ Per potenziare il segnale di comando del regolatore MaxLED



**Mono Color Amplifier**

max. 144 W  
 DC 24 V  
 ⌀24 ⇄105 ⌀65 mm  
 EAN 4000870 706848  
**706.84**



**RGB Amplifier**

max. 144 W  
 DC 24 V  
 ⌀24 ⇄105 ⌀65 mm  
 EAN 4000870 706855  
**706.85**



- ↳ Matt aluminium Metal
- ↳ Aluminio mate Metal
- ↳ Alluminio opaco Metallo

- ↳ Matt aluminium Metal
- ↳ Aluminio mate Metal
- ↳ Alluminio opaco Metallo



**Smart Home** ☰ = 386-403

Comfortably control your lighting with your smart phone or remote control, using the additional products from the Smart Home chapter (P. 386-403).

Controle su luz cómodamente mediante el smartphone o el mando a distancia con los productos complementarios del capítulo Smart Home (p. 386-403)

Comandate le vostre luci comodamente utilizzando lo smartphone o il telecomando con i prodotti supplementari del capitolo Smart Home (pag. 386-403).

## YourLED Stripe

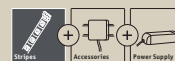

## Accessories

📖 = 194 »



## Power Supply

📖 = 196

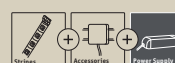

Power Supply 15 W 230/12V DC



Power Supply 48 W 230/12V DC



Power Supply 60 W 230/12V DC

## YourLED ECO Stripe

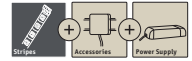

YourLED ECO RGB



- Black Metal
- Negro Metal
- Nero Metallo



Accessories  
= 194-199

### ECO Strip RGB 50cm

incl. 1x3 W  
Deco  
∠ 120°  
DC 12 V  
∅ 2,5 mm ∅ 10,5 mm ⇄ 0,5 m  
EAN 4000870 701980  
**701.98**



### ECO Strip RGB 1m

incl. 1x6 W  
Deco  
∠ 120°  
DC 12 V  
∅ 2,5 mm ∅ 10,5 mm ⇄ 1 m  
EAN 4000870 704608  
**704.60**



### ECO Strip RGB 3m

incl. 1x14,5 W  
Deco  
∠ 120°  
DC 12 V  
∅ 2,5 mm ∅ 10,5 mm ⇄ 3 m  
EAN 4000870 702529  
**702.52**



### ECO Strip RGB 5m

incl. 1x18 W  
Deco  
∠ 120°  
DC 12 V  
∅ 2,5 mm ∅ 10,5 mm ⇄ 5 m  
EAN 4000870 702536  
**702.53**



### ECO Basic Set RGB 3m expanded max. 8m

incl. 1x14,5 W  
Deco  
∠ 120°  
230/12 V, incl. 24 VA  
∅ 2,5 mm ∅ 10,5 mm ⇄ 3 m  
EAN 4000870 704301  
**704.30**





YourLED ECO



- 🔌 White 📦 Metal
- 🔌 Blanco 📦 Metal
- 🔌 Bianco 📦 Metallo



Accessories  
📦 = 194-199



**ECO Strip Warm white 50cm**

A++-A

incl. 1x1,2W  
80 lm, 3.000K  
∠ 120°  
DC 12V  
⌀2,5 mm ⌀10,5 mm ⇄0,5 m  
EAN 4000870 701966  
**701.96** 📦



**ECO Strip Warm white 1m**

A++-A

incl. 1x2,4W  
160 lm, 3.000K  
∠ 120°  
DC 12V  
⌀2,5 mm ⌀10,5 mm ⇄1 m  
EAN 4000870 704592  
**704.59** 📦

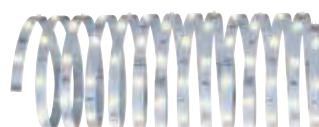
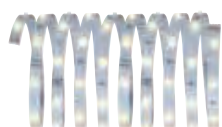

**ECO Strip Warm white 3m**

A++-A

incl. 1x6,8W  
480 lm, 3.000K  
∠ 120°  
DC 12V  
⌀2,5 mm ⌀10,5 mm ⇄3 m  
EAN 4000870 702543  
**702.54** 📦



**ECO Strip Warm white 5m**

A++-A

incl. 1x10,5W  
780 lm, 3.000K  
∠ 120°  
DC 12V  
⌀2,5 mm ⌀10,5 mm ⇄5 m  
EAN 4000870 702550  
**702.55** 📦



**ECO Basic Set Warm white 3m expanded max. 6m**

A++-A

incl. 1x6,8W  
480 lm, 3.000K  
∠ 120°  
230/12V, incl. -📦 12 VA  
⌀2,5 mm ⌀10,5 mm ⇄3 m  
EAN 4000870 704288  
**704.28** 📦



**ECO Strip Neutral white 50cm**

A++-A

incl. 1x1,2W  
90 lm, 4.000K  
∠ 120°  
DC 12V  
⌀2,5 ⇄500 ⌀10,5 mm  
EAN 4000870 701973  
**701.97** 📦



**ECO Strip Neutral white 1m**

A++-A

incl. 1x2,4W  
180 lm, 4.000K  
∠ 120°  
DC 12V  
⌀2,5 mm ⌀10,5 mm ⇄1 m  
EAN 4000870 704585  
**704.58** 📦

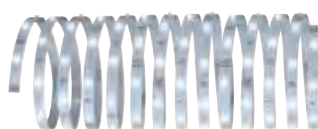
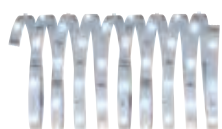

**ECO Strip Neutral white 3m**

A++-A

incl. 1x6,8W  
540 lm, 4.000K  
∠ 120°  
DC 12V  
⌀2,5 mm ⌀10,5 mm ⇄3 m  
EAN 4000870 702567  
**702.56** 📦



**ECO Strip Neutral white 5m**

A++-A

incl. 1x10,5W  
900 lm, 4.000K  
∠ 120°  
DC 12V  
⌀2,5 mm ⌀10,5 mm ⇄5 m  
EAN 4000870 702574  
**702.57** 📦



**ECO Basic Set Neutral white 3m expanded max. 6m**

A++-A

incl. 1x6,8W  
540 lm, 4.000K  
∠ 120°  
230/12V, incl. -📦 12 VA  
⌀2,5 mm ⌀10,5 mm ⇄3 m  
EAN 4000870 704295  
**704.29** 📦



## YourLED Stripe

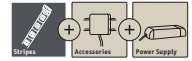

- White Plastic
- Blanco Plástico
- Bianco Plastica



Accessories  
= 194-199



**Strip RGB 98cm** A++-A

incl. 1x7W  
Deco  
∠ 120°  
DC 12V  
∅3 ⇄975 ∅10,5mm  
EAN 4000870 702109  
**702.10**

**Strip RGB 3m** A++-A

incl. 1x17,8W  
Deco  
∠ 120°  
DC 12V  
∅3mm ∅10,5mm ⇄3m  
EAN 4000870 705940  
**705.94**

**Distance Pack RGB** A++-A

incl. 2x0,24 / 2x0,72 W  
∠ 120°  
DC 12V  
∅3 ⇄30/75 ∅10,5mm  
EAN 4000870 703380  
**703.38**



**Basic Set RGB 1,5m expanded max. 3m** A++-A

incl. 1x10W  
Deco  
∠ 120°  
230/12V, incl. 18VA  
∅3mm ∅10,5mm ⇄1,5m  
EAN 4000870 703199  
**703.19**

**Basic Set RGB 3m expanded max. 5m** A++-A

incl. 1x17,8W  
Deco  
∠ 120°  
230/12V, incl. 24VA  
∅3mm ∅10,5mm ⇄3m  
EAN 4000870 703229  
**703.22**

**Distance Pack RGB**

Icon 1	Icon 2	Icon 3	Icon 4	L (mm)	Watt(W)
✓				30	0,24
✓	✓			60	0,48
		✓		75	0,72
✓		✓		105	0,96
✓	✓	✓		135	1,20
		✓	✓	150	1,44
✓		✓	✓	180	1,68
✓	✓	✓	✓	210	1,92

YourLED



- 🌀 White 🧱 Plastic
- 🌀 Blanco 🧱 Plástico
- 🌀 Bianco 🧱 Plastica



Accessories  
☐ = 194-199

### Strip Warm white 97cm

incl. 1x3 W  
265 lm, 3.000 K  
∠ 120°  
DC 12 V  
⌀3 ⇔975 ⌀10,5 mm  
EAN 4000870 702086  
**702.08**

A++-A



### Strip Warm white 3m

incl. 1x7,5 W  
800 lm, 3.000 K  
∠ 120°  
DC 12 V  
⌀3 mm ⌀10,5 mm ⇔3 m  
EAN 4000870 705926  
**705.92**

A++-A



### Distance Pack Warm white

incl. 2x0,08 / 2x0,24 W  
3.000 K  
∠ 120°  
DC 12 V  
⌀3 ⇔25/75 ⌀10,5 mm  
EAN 4000870 703366  
**703.36**

A++-A



Distance Pack Warm white				L (mm)	Watt(W)
☐	☐	☐	☐	25	0,08
✓	✓			50	0,16
		✓		75	0,24
✓		✓		100	0,32
✓	✓	✓		125	0,40
		✓	✓	150	0,48
✓		✓	✓	175	0,56
✓	✓	✓	✓	200	0,64



### Basic Set Warm white 1,5m expanded max. 4,8m

incl. 1x4,5 W  
400 lm, 3.000 K  
230/12 V, incl. - 12 VA  
⌀3 mm ⌀10,5 mm ⇔1,5 m  
EAN 4000870 703175  
**703.17**

A++-A

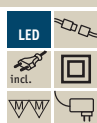

### Basic Set Warm white 3m expanded max. 7,6m

incl. 1x7,5 W  
800 lm, 3.000 K  
230/12 V, incl. - 18 VA  
⌀3 mm ⌀10,5 mm ⇔3 m  
EAN 4000870 703205  
**703.20**

A++-A

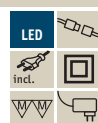

### Strip Daylight 97cm

incl. 1x3 W  
270 lm, 6.000 K  
∠ 120°  
DC 12 V  
⌀3 ⇔975 ⌀10,5 mm  
EAN 4000870 702093  
**702.09**

A++-A



### Strip Daylight 3m

incl. 1x7,5 W  
810 lm, 6.000 K  
∠ 120°  
DC 12 V  
⌀3 mm ⌀10,5 mm ⇔3 m  
EAN 4000870 705933  
**705.93**

A++-A



### Distance Pack Daylight

incl. 2x0,08 / 2x0,24 W  
6.000 K  
∠ 120°  
DC 12 V  
⌀3 ⇔25/75 ⌀10,5 mm  
EAN 4000870 703373  
**703.37**

A++-A



Distance Pack Daylight				L (mm)	Watt(W)
☐	☐	☐	☐	25	0,08
✓	✓			50	0,16
		✓		75	0,24
✓		✓		100	0,32
✓	✓	✓		125	0,40
		✓	✓	150	0,48
✓		✓	✓	175	0,56
✓	✓	✓	✓	200	0,64



### Basic Set Daylight 1,5m expanded max. 4,8m

incl. 1x4,5 W  
405 lm, 6.000 K  
230/12 V, incl. - 12 VA  
⌀3 mm ⌀10,5 mm ⇔1,5 m  
EAN 4000870 703182  
**703.18**

A++-A



### Basic Set Daylight 3m expanded max. 7,6m

incl. 1x7,5 W  
810 lm, 6.000 K  
230/12 V, incl. - 18 VA  
⌀3 mm ⌀10,5 mm ⇔3 m  
EAN 4000870 703212  
**703.21**

A++-A



for  
RGB Color  
□ = 190, 194

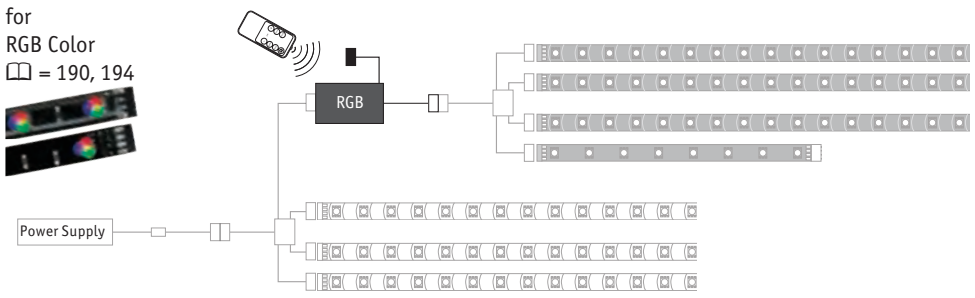

Plastic  
Plástico  
Plastica

- ▶ Necessary for controlling yourLED and yourLED ECO RGB stripes
- ▶ IR remote control with free selection of preset colours as well as for fine adjustment of the individual colour channels as needed. 4 programs (colour change, strobe, ...)
- ▶ Dimming in three steps.
- ▶ Dimming in three stages

- ▶ Necesario para el control de tiras RGB yourLED y yourLED ECO
- ▶ Mando a distancia IR con elección libre de colores preajustados así como el ajuste fino de los canales de color individuales según se necesite. 4 programas (cambio de color, estroboscopio, ...)
- ▶ Regulable en tres niveles.
- ▶ Luz regulable en tres niveles

- ▶ Necessario al pilotaggio delle strisce RGB yourLED e yourLED ECO
- ▶ Telecomando a infrarossi con selezione a piacere dei colori preimpostati e sintonia fine dei singoli canali cromatici in base alle necessità. 4 programmi (cambio di colore, stroboscopio, ecc.)
- ▶ Tre livelli di regolazione dell'intensità luminosa.
- ▶ Possibilità di regolazione su tre livelli



**RGB-Controller 12V DC**

max. 60W  
CR 2025 × 1  
DC 12V  
22 ↔ 60 35 mm  
EAN 4000870 702024  
**702.02**



for  
RGB Color  
□ = 190, 194

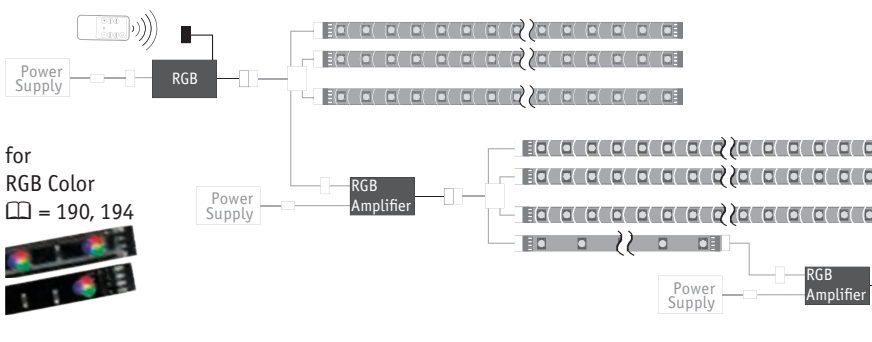

Aluminium/Matt Metal  
Aluminio/Mate Metal  
Alluminio/Opaco Metallo

- ▶ Amplifying the control signal from the type 702.02 YourLED controller.
- ▶ This is how to use a remote control to synchronously control larger YourLED or YourLED ECO RGB strip systems.
- ▶ An additional power supply unit is attached to each amplifier to increase the power of the system

- ▶ Para amplificar la señal de control de la controladora RGB YourLED (Art. N° 702.02).
- ▶ Así pueden controlarse con un mando a distancia mayores sistemas RGB-Stripe YourLED o YourLED ECO sincronizadamente.
- ▶ Mediante cada amplificador se conecta una fuente de alimentación adicional, para ampliar la potencia del sistema

- ▶ Per potenziare il segnale di comando del regolatore RGB YourLED Art. 702.02.
- ▶ Un telecomando permette di comandare sincronicamente grandi sistemi di strisce YourLED o YourLED ECO RGB.
- ▶ A ogni amplificatore viene collegata un'ulteriore fonte di alimentazione per implementare la potenza del sistema



**RGB Amplifier**

max. 60W  
DC 12V  
24 ↔ 105 65 mm  
EAN 4000870 703359  
**703.35**



for  
Stripe  
□ 191, 195

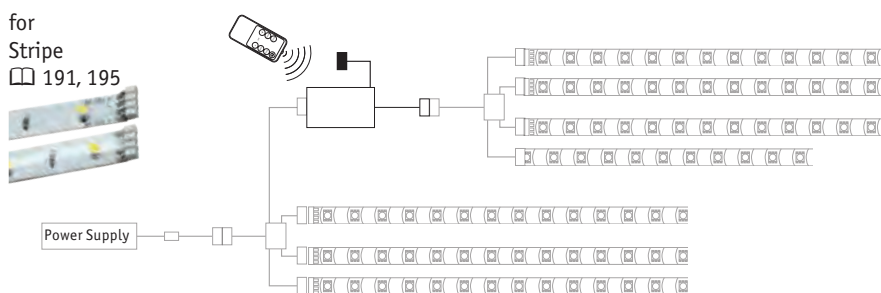

🌀 White 🧱 Plastic  
🌀 Blanco 🧱 Plástico  
🌀 Bianco 🧱 Plastica

- ▶ For switching on or off or dimming the monochrome YourLED, YourLED ECO or DECO Stripes
- ▶ The controller with remote control makes operation easy and provides a pleasant, dimmable mood light.
- ▶ Para conmutar o regular regletas monocolor de YourLED, YourLED ECO o DECO
- ▶ El mando a distancia ofrece confort y convence por su agradable luz regulable.
- ▶ Per commutare o regolare l'intensità delle strisce YourLED, YourLED ECO o DECO monocromatiche
- ▶ Il regolatore con comando remoto offre il comfort necessario e affascina con una piacevole luce d'atmosfera regolabile.



#### Dimm/Switch Controller IR

max. 60 W  
CR 2025 × 1  
DC 12 V  
⌀22 ⇄63 ↗35 mm  
EAN 4000870 704615  
**704.61** 📦



for  
Stripe  
□ 191, 195

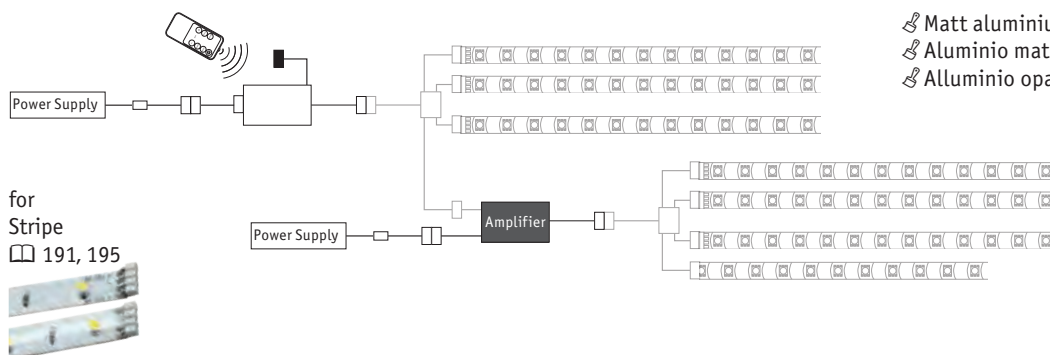

🌀 Matt aluminium 🧱 Metal  
🌀 Aluminio mate 🧱 Metal  
🌀 Alluminio opaco 🧱 Metallo

- ▶ Amplifying the control signal from the YourLED dimmer/controller type 70461
- ▶ This is how to use a remote control to synchronously control larger monochrome YourLED, YourLED ECO or DECO Stripe systems
- ▶ An additional power supply unit is attached to each amplifier to increase the power of the system
- ▶ Para amplificar la señal de control de la controladora/regulador de YourLED (Art. N° 70461)
- ▶ Así pueden controlarse o regular con un mando a distancia mayores sistemas de regletas YourLED, YourLED ECO o DECO sincronizadamente
- ▶ Mediante cada amplificador se conecta una fuente de alimentación adicional, para ampliar la potencia del sistema
- ▶ Per potenziare il segnale di comando del regolatore/commutatore YourLED 70461
- ▶ Un telecomando permette di comandare o regolare in maniera sincronizzata grandi sistemi di strisce YourLED, YourLED ECO o DECO monocromatiche
- ▶ A ogni amplificatore viene collegata un'ulteriore fonte di alimentazione per implementare la potenza del sistema



#### Amplifier

max. 60 W  
DC 12 V  
⌀24 ⇄105 ↗65 mm  
EAN 4000870 704523  
**704.52** 📦







	15 W Power Supply / Tranfo	48 W Power Supply / Tranfo	60 W Power Supply / Tranfo
	<b>max.</b>		
YourLED	<b>4m</b>	<b>15m</b> (9m + 6m)*	<b>19m</b> (9m + 9m + 1m)*
YourLED RGB	<b>1m</b>	<b>5m</b> (4m + 1m)*	<b>6m</b> (4m + 2m)*
YourLED ECO	<b>6m</b>	<b>20m</b> (12m + 8m)*	<b>25m</b> (12m + 12m + 1m)*
YourLED ECO RGB	<b>2m</b>	<b>6,5m</b> (6m + 0,5m)*	<b>8m</b> (6m + 2m)*

\* To reach full efficiency of the system, use the junktionbox 702.03  
 \* Para aprovechar al máximo la potencia del sistema utilice la caja de conexión 702.03  
 \* Per godere a pieno della potenza del sistema utilizzare il Junctionbox 702.03



Grey/Black Plastic  
 Gris/Negro Plástico  
 Grigio/Nero Plastica

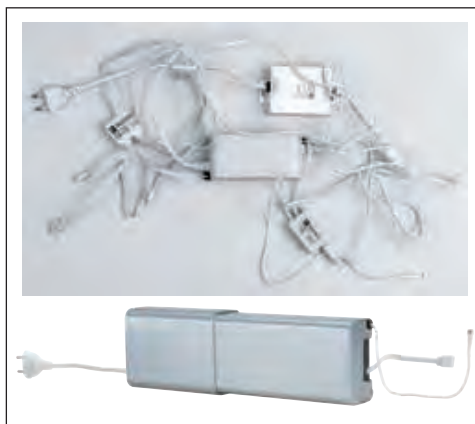
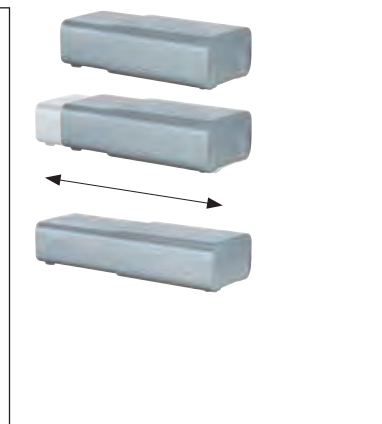

 <p><b>Power Supply 230/12V DC</b>                  max. 15 W                  230/12 V, incl. 15 VA                  18 ⇄ 125 40 mm                  EAN 4000870 701997  <b>701.99</b></p>	 <p><b>Power Supply 230/12V DC</b>                  max. 48 W                  230/12 V, incl. 48 VA                  40 ⇄ 135 55 mm                  EAN 4000870 702000  <b>702.00</b></p>	 <p><b>Power Supply 60W 230/12V DC IP65</b>                  max. 60 W                  230/12 V, incl. 60 VA                  40 ⇄ 225 60 mm                  EAN 4000870 702017  <b>702.01</b></p>
--	--	--

		<p><b>Trafobox</b></p> <p>58 ⇄ 96 208-308 mm                  EAN 4000870 705919  <b>705.91</b></p> <p>Chrome matt Plastic/Aluminium                  Cromo mate Plástico/Aluminio                  Cromo opaco Plastica/Alluminio</p>
---	---	--



**Smart Home** ☎ = 386-403



Comfortably control your lighting with your smart phone or remote control, using the additional products from the Smart Home chapter (P. 386-403).

Controle su luz cómodamente mediante el smartphone o el mando a distancia con los productos complementarios del capítulo Smart Home (p. 386-403)

Comandate le vostre luci comodamente utilizzando lo smartphone o il telecomando con i prodotti supplementari del capitolo Smart Home (pag. 386-403).



(mm)

PIR-Sensor  
on/off  
50-100  
10°

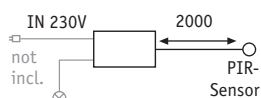
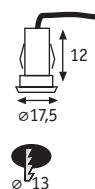

White Plastic  
Blanco Plástico  
Bianco Plastica

- ▶ Proximity switch for switching on and off the LED stripes and other products
- ▶ Max. 75 W (magnetic transformers)
- ▶ Max. 60 W (electronic load)
- ▶ Max. 250 W (light bulbs)
- ▶ Interruptor de proximidad para encender/apagar regletas LED-stripes y otros productos
- ▶ Máx. 75 W (transformadores magnéticos)
- ▶ Máx. 60 W (carga electrónica)
- ▶ Máx. 250 W (lámparas incandescentes)
- ▶ Interrupteur de proximité Marche/Arrêt des rubans LED et autres produits
- ▶ Max. 75 W (trasformatori magnetici)
- ▶ Max. 60 W (carico elettronico)
- ▶ Max. 250 W (lampadine a incandescenza)



#### PIR-Sensor 230V

max. 60 W  
230 V  
19  $\leftrightarrow$  17,5  $\leftrightarrow$  85  $\nearrow$  36 mm  
EAN 4000870 704516  
**704.51**



for  
Stripe  
191, 195



#### IR-Sensor

max. 60 W  
DC 12 V  
18  $\leftrightarrow$  50  $\nearrow$  36 mm  
EAN 4000870 707265  
**707.26** **new**

White Plastic  
Blanco Plástico  
Bianco Plastica



for  
Stripe  
191, 195



#### On/Off Switch

max. 60 W  
DC 12 V  
15  $\leftrightarrow$  60  $\nearrow$  26 mm  
EAN 4000870 707272  
**707.27** **new**

White Plastic  
Blanco Plástico  
Bianco Plastica

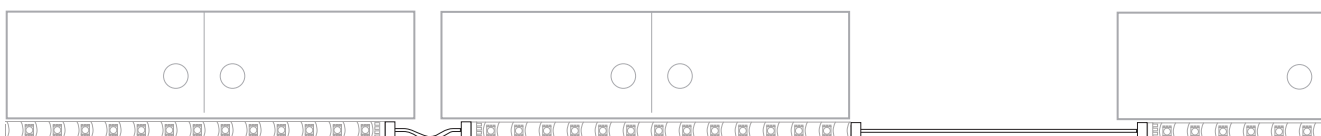

#### Flex-Connector 10cm

5 mm  $\leftrightarrow$  13 mm  $\leftrightarrow$  0,1 m  
EAN 4000870 702154  
**702.15**

White Plastic  
Blanco Plástico  
Bianco Plastica



#### Flex-Connector 1m

13 mm  $\nearrow$  5 mm  $\leftrightarrow$  1 m  
EAN 4000870 702048  
**702.04**

White Plastic  
Blanco Plástico  
Bianco Plastica



#### Flex-Connector 5m

13 mm  $\nearrow$  5 mm  $\leftrightarrow$  5 m  
EAN 4000870 702512  
**702.51**

White Plastic  
Blanco Plástico  
Bianco Plastica



**Junction-Box**

∅12 ↔30 ∇45 mm  
EAN 4000870 702031

**702.03**

- 🌀 White 📦 Plastic
- 🌀 Blanco 📦 Plástico
- 🌀 Bianco 📦 Plastica



**X-Connector**

∅7 ↔33 ∇33 mm  
EAN 4000870 702826

**702.82**

- 🌀 White 📦 Plastic
- 🌀 Blanco 📦 Plástico
- 🌀 Bianco 📦 Plastica



**Edge-Connector Pack**

max. 60 W  
∅12 ↔17 ∇13 mm  
EAN 4000870 703342

**703.34**

- 🌀 White/Black
- 🌀 Blanco/Negro
- 🌀 Bianco/Nero

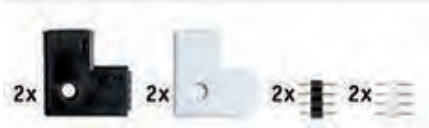

**Edge-Connector 90° Pack**

max. 60 W  
∅5 ↔23 ∇23 mm  
EAN 4000870 705995

**705.99**

- 🌀 White/Black
- 🌀 Blanco/Negro
- 🌀 Bianco/Nero

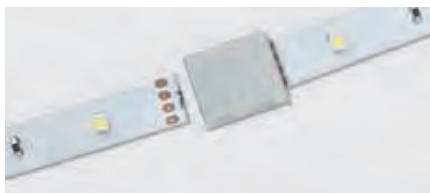

**ECO Clip-to-Clip Connector Pack**

∅6 ↔13,5 ∇14 mm  
EAN 4000870 704899

**704.89**

- 🌀 White 📦 Plastic
- 🌀 Blanco 📦 Plástico
- 🌀 Bianco 📦 Plastica

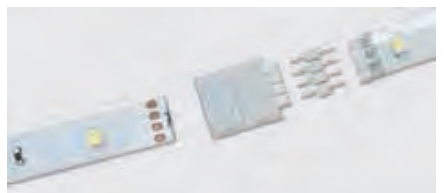

**ECO Clip-to-YourLED Connector Pack**

∅6 ↔13 ∇18 mm  
EAN 4000870 704905

**704.90**

- 🌀 White 📦 Plastic
- 🌀 Blanco 📦 Plástico
- 🌀 Bianco 📦 Plastica

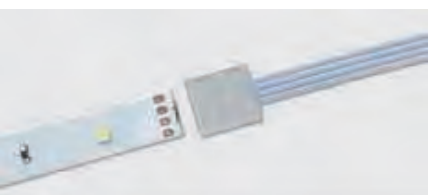

**ECO Clip Connector Pack**

∅6 mm ↔13,5 mm ↔0,5 m  
EAN 4000870 704882

**704.88**

- 🌀 White 📦 Plastic
- 🌀 Blanco 📦 Plástico
- 🌀 Bianco 📦 Plastica

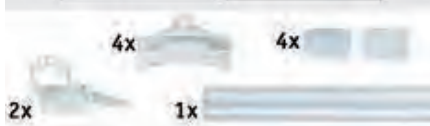

**Mounting Pack**

EAN 4000870 705902

**705.90**

- 📦 Plastic
- 📦 Plástico
- 📦 Plastica





- 🔗 White 📦 Plastic
- 🔗 Blanco 📦 Plástico
- 🔗 Bianco 📦 Plastica

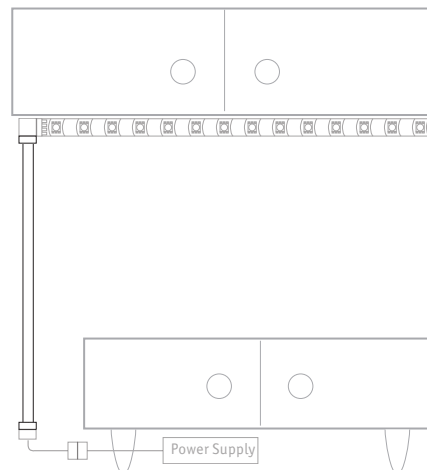

**Flat Connector**

⌀10 mm ⇔19 mm ↗16,5 mm ⇔3 m

EAN 4000870 704868

704.86 📦 new



**Flat Connector**

⌀10 mm ⇔19 mm ↗16,5 mm ⇔5 m

EAN 4000870 704875

704.87 📦 new



- 🔗 Transparent 📦 Plastic
- 🔗 Transparente 📦 Plástico
- 🔗 Trasparente 📦 Plastica



- ▶ For achieving an IP protection on coated YourLED stripes
- ▶ Protects the linkage points between stripes and system plugs
- ▶ 4:1 Shrink ratio

- ▶ Para la protección IP de tiras YourLED con revestimiento
- ▶ Protege los puntos de unión entre tiras y enchufes
- ▶ Tasa de contracción 4:1

- ▶ Per ottenere una protezione IP delle strisce YourLED rivestite
- ▶ Protegge i punti di collegamento tra le strisce e le spine del sistema
- ▶ Rapporto di restringimento 4:1



**Water Protection**

⌀14 ⇔150 mm

EAN 4000870 702475

702.47 📦

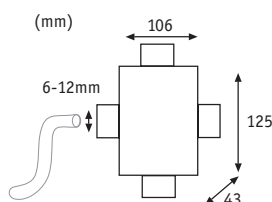

- 🔗 Black 📦 Plastic
- 🔗 Negro 📦 Plástico
- 🔗 Nero 📦 Plastica

- ▶ Connection box for up to 4 lines
- ▶ Unused outputs remain closed
- ▶ Dust- and waterproof (IP67)

- ▶ Caja de conexión para 4 cables
- ▶ Las tomas que no se usan permanecen cerradas
- ▶ Hermético al polvo y protegido frente a inmersión en agua (IP67)

- ▶ Scatola di collegamento fino a 4 linee
- ▶ Le uscite inutilizzate rimangono chiuse
- ▶ Protezione da penetrazione di polvere e breve immersione in acqua (IP67)



**Special Line Junction-Box**

max. 2.500 W

⌀140 ⇔110 ↗55 mm

EAN 4000870 002322

232 📦

🔗 IP67

## YourLED IP 44 Stripe



- ▶ YourLED LED strips for splash-protected installation in bathrooms and damp rooms (IP44). The coated strips are optimally sealed at the connection points by means of shrink tubing.
  - ▶ Reliable splash protection, thanks to large amount of shrinking and hot-melt adhesive seal
  - ▶ Optimal sealing results using a customary hot air gun
  - ▶ Can be combined with YourLED connectors and accessories
  - ▶ Easy mounting thanks to plug-in connections
  - ▶ Self-adhesive, flexible; can be shortened in the same way as the well-known YourLED LED strips
- ▶ Regletas de LEDs YourLED para montar protegidas frente a salpicaduras de agua en baños y ambientes húmedos (IP44). Las regletas recubiertas se impermeabilizan óptimamente mediante tubo contráctil en los puntos de conexión.
  - ▶ Fiable protección contra salpicaduras de agua gracias al alto grado de contractibilidad de la junta y al adhesivo de fusión
  - ▶ Óptima estanqueización sencillamente con la ayuda de un secador de pelo corriente
  - ▶ Combinable con accesorios y conectores YourLED
  - ▶ Montaje sencillo mediante conectores
  - ▶ Autoadhesivas, flexibles y recortables como las conocidas regletas YourLED
- ▶ Strisce di LED YourLED per il montaggio a prova di spruzzi d'acqua in bagno o in altri ambienti umidi (IP44). Le strisce rivestite vengono rese stagne mediante applicazione di un tubo termoretraibile nei punti di collegamento.
  - ▶ Protezione affidabile contro gli spruzzi d'acqua grazie all'elevata restringibilità e alla tenuta termoplastica
  - ▶ Per ottimi risultati di tenuta è sufficiente usare l'aria calda di un comune asciugacapelli
  - ▶ Combinabili con connettori e accessori YourLED
  - ▶ Montaggio semplice con connessioni a innesto
  - ▶ Autoadesive, flessibili e accorciabili come le note strisce LED YourLED





- 🔗 Black 📦 Plastic
- 🔗 Negro 📦 Plástico
- 🔗 Nero 📦 Plastica

Accessories  
📦 = 194-199



**Strip RGB IP44 97cm**

incl. 1x7 W  
Deco  
∠ 120°  
DC 12 V  
⌀3 ⇄975 ⌀10,5 mm  
EAN 4000870 703113  
**703.11**



**Strip Pack RGB IP44 3x97cm**

incl. 3x7 W  
Deco  
∠ 120°  
DC 12 V  
⌀3 ⇄2.925 ⌀10,5 mm  
EAN 4000870 703120  
**703.12**

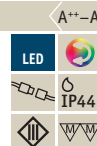

**Basic Set RGB 3m IP44**

incl. 1x17,8 W  
Deco  
∠ 120°  
230/12 V, incl. ⚡24 VA  
⌀3 mm ⌀10,5 mm ⇄3 m  
EAN 4000870 705124  
**705.12**

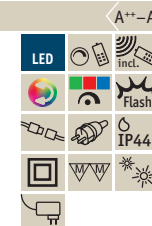

- 🔗 White 📦 Plastic
- 🔗 Blanco 📦 Plástico
- 🔗 Bianco 📦 Plastica

Accessories  
📦 = 194-199



**Strip Warm white IP44 97cm**

incl. 1x3 W  
265 lm, 3.000 K  
∠ 120°  
DC 12 V  
⌀3 ⇄975 ⌀10,5 mm  
EAN 4000870 703090  
**703.09**



**Strip Pack Warm white IP44 3x97cm**

incl. 3x3 W  
3x795 lm, 3.000 K  
∠ 120°  
DC 12 V  
⌀3 ⇄2.925 ⌀10,5 mm  
EAN 4000870 704073  
**704.07**



**Basic Set Warm white 3m IP44**

incl. 1x7,5 W  
800 lm, 3.000 K  
∠ 120°  
230/12 V, incl. ⚡18 VA  
⌀3 mm ⌀10,5 mm ⇄3 m  
EAN 4000870 705100  
**705.10**

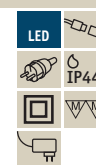

**Strip Daylight IP44 97cm**

incl. 1x3 W  
270 lm, 6.000 K  
∠ 120°  
DC 12 V  
⌀3 ⇄975 ⌀10,5 mm  
EAN 4000870 703106  
**703.10**



**Strip Pack Daylight IP44 3x97cm**

incl. 3x3 W  
3x810 lm, 6.000 K  
∠ 120°  
DC 12 V  
⌀3 ⇄2.925 ⌀10,5 mm  
EAN 4000870 704080  
**704.08**



**Basic Set Daylight 3m IP44 expanded max. 7,5m**

incl. 1x7,5 W  
810 lm, 6.000 K  
∠ 120°  
230/12 V, incl. ⚡18 VA  
⌀3 mm ⌀10,5 mm ⇄3 m  
EAN 4000870 705117  
**705.11**

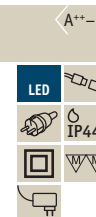

## WaterLED IP67



- ▶ Fully jacketed LED strips for decorative outdoor lighting in the garden, at the property entrance, below lintels, in damp rooms or for many other uses (IP67 - able to withstand immersion in water).
- ▶ Plug-and-play: Complete set with plug for easy installation
- ▶ Incl. transformer (IP 64: dust-proof and splash-protected).
- ▶ Incl. 1 m power cable - 5 m extension cable available as accessory (IP 65: waterjet-protected)
- ▶ LED strips can be shortened every 10 cm - end cap and silicone sealing agent incl.
- ▶ For loose placement or fixed installation using plastic brackets (incl.)
- ▶ Not suitable for use in the vicinity of aggressive chemicals (chlorine water and similar)
- ▶ Regletas de led completamente revestidas para iluminación exterior decorativa en el jardín, en la entrada a la casa, bajo el alero, en espacios húmedos y en muchos otros lugares (IP67 - protección contra inmersión en agua).
- ▶ Plug'n'play: juego completo listo para enchufar, simplificándose el tendido
- ▶ Transformador incl. (IP64 - hermético al polvo y a salpicaduras de agua).
- ▶ Cable de alim. de 1 m incl. (prolongador de 5 m disponible como accesorio; IP65 - resistente a chorro de agua proyectada)
- ▶ Las regletas de LEDs se pueden recortar cada 10 cm (moldura de cierre y sellado de silicona incluidos)
- ▶ Para tendido libre o para fijar con presillas de plástico (incluidas)
- ▶ No apto para ambientes con sustancias químicas agresivas (p.ej. agua clorada)
- ▶ Strisce di LED rivestite su tutti i lati per illuminazione decorativa di esterni: in giardino, sopra l'ingresso, sotto la traversa del tetto, in ambienti umidi e in molti altri punti (protezione contro l'immersione in acqua - IP67).
- ▶ Plug ,n' play: set completo pronto al collegamento per la massima facilità di posa
- ▶ Trasformatore incluso (con protezione contro penetrazione di polvere e spruzzi d'acqua - IP64).
- ▶ Cavo di alimentazione da 1 m incluso - Prolunga da 5 m disponibile come accessorio (con protezione dai getti diretti d'acqua - IP65)
- ▶ Le strisce di LED sono accorciabili ogni 10 cm - Calotta terminale e sigillante al silicone inclusi
- ▶ Per la posa mobile o il fissaggio con staffe in plastica (incluse)
- ▶ Non adatte all'impiego in presenza di sostanze chimiche aggressive (acqua clorurata o simili)



White/Multicolour Plastic  
 Blanco/Multicolor Plástico  
 Bianco/Multicolore Plastica



**WaterLED Multicolor 3m**

incl. 1x7 W  
 220 lm  
 230/12 V, incl. 7,2 VA  
 ⌀4,5 mm ⌀10 mm ⇄3 m  
 EAN 4000870 704165  
**704.16**

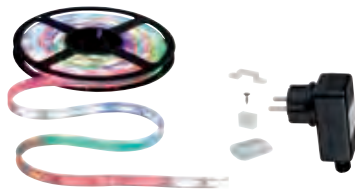

**WaterLED Multicolor 5m**

incl. 1x10,5 W  
 350 lm  
 230/12 V, incl. 12 VA  
 ⌀4,5 mm ⌀10 mm ⇄5 m  
 EAN 4000870 704158  
**704.15**

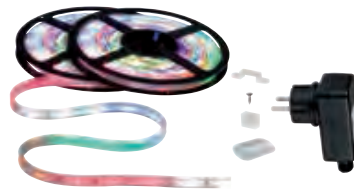

**WaterLED Multicolor 7,5m**

incl. 1x14 W  
 550 lm  
 230/12 V, incl. 18 VA  
 ⌀4,5 mm ⌀10 mm ⇄7,5 m  
 EAN 4000870 704141  
**704.14**



White/Multicolour Plastic  
 Blanco/Multicolor Plástico  
 Bianco/Multicolore Plastica



**WaterLED Neutral white 3m**

incl. 1x7 W  
 420 lm, 4.000 K  
 230/12 V, incl. 7,2 VA  
 ⌀4,5 mm ⌀10 mm ⇄3 m  
 EAN 4000870 704196  
**704.19**

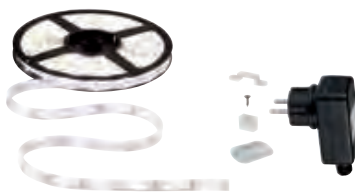

**WaterLED Neutral white 5m**

incl. 1x10,5 W  
 700 lm, 4.000 K  
 230/12 V, incl. 12 VA  
 ⌀4,5 mm ⌀10 mm ⇄5 m  
 EAN 4000870 704189  
**704.18**



**WaterLED Neutral white 7,5m**

incl. 1x14 W  
 1.000 lm, 4.000 K  
 230/12 V, incl. 18 VA  
 ⌀4,5 mm ⌀10 mm ⇄7,5 m  
 EAN 4000870 704172  
**704.17**

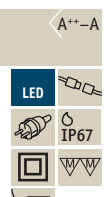

**WaterLED Flex-Connector 5m**

DC 12 V  
 ⇄5 m  
 EAN 4000870 704134  
**704.13**



Black Rubber  
 Negro Goma  
 Nero Gomma

## WaterLED Digital Motion IP 67



- ▶ LED Stripe set with 164 functions for a range of different light effects, can be shortened electronically
- ▶ The digital control allows colours to be mixed in dynamic rhythms
- ▶ Can be dimmed or switched on or off by remote control.
- ▶ 3 LEDs can be disconnected from the strip end in segments. This allows the strip to be installed in a range of locations at the appropriate length.
- ▶ Juego de regleta LED electrónica acortable con 164 funciones para diversos efectos lumínicos
- ▶ El control digital permite mezclar colores a ritmos dinámicos
- ▶ Conmutable y regulable por mando a distancia.
- ▶ Desde el extremo de la regleta se pueden desconectar 3 LED por segmento. Así se puede colocar la regleta en la longitud adecuada en distintos lugares.
- ▶ Set di strisce LED accorciabili con 164 funzioni per molteplici effetti di luce
- ▶ Il sistema di comando digitale consente di miscelare i colori con ritmi dinamici
- ▶ Commutabile e regolabile tramite telecomando.
- ▶ Dalle estremità delle strisce è possibile disinserire 3 LED per segmento. In questo modo la striscia può essere utilizzata in diversi punti con una lunghezza differente.



- 🔌 White/Multicolour 🧱 Plastic
- 🔌 Blanco/Multicolor 🧱 Plástico
- 🔌 Bianco/Multicolore 🧱 Plastica



### WaterLED Digital Motion Color Set 3m

A++-A

incl. 1x6,4 W  
160 lm  
230/12 V, incl. ⚡ 24 VA  
⤴5 ⤵↔3.050 ⤶12 mm  
EAN 4000870 706985  
**706.98** 📦



### WaterLED Digital Motion Color Set 4.88 m

A++-A

incl. 1x9,8 W  
256 lm  
230/12 V, incl. ⚡ 24 VA  
⤴5 ⤵↔4.880 ⤶12 mm  
EAN 4000870 706992  
**706.99** 📦





## BlackLight LED

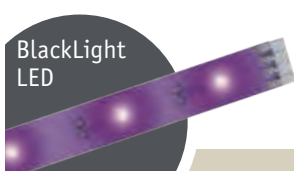
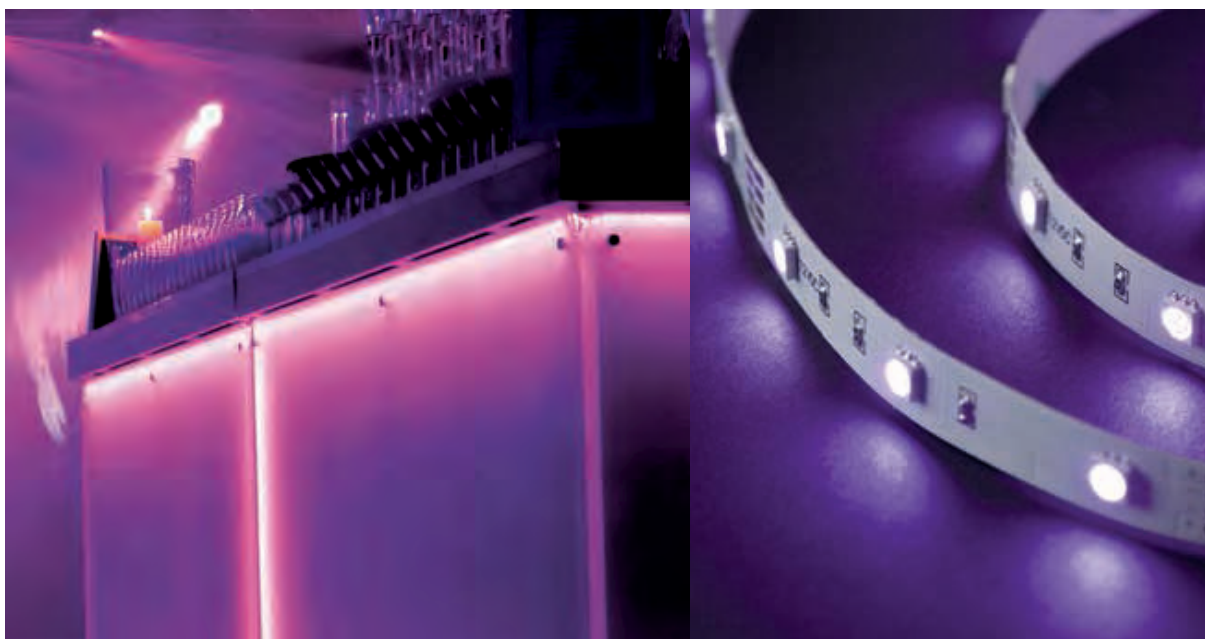

Blacklight  
Luz negra  
Luce nera

White Plastic  
Blanco Plástico  
Bianco Plastica

Accessories  
= 194-199



### BlackLight LED Strip Set 1m

incl. 1x6W  
230/12V, incl. 8,4VA  
2,5 mm 10,5 mm 1 m  
EAN 4000870 703281  
**703.28**

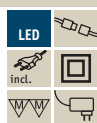

### BlackLight LED Strip Set 3m

incl. 1x18W  
230/12V, incl. 18VA  
2,5 mm 10,5 mm 3 m  
EAN 4000870 703298  
**703.29**





## Digital LED Strip Motion

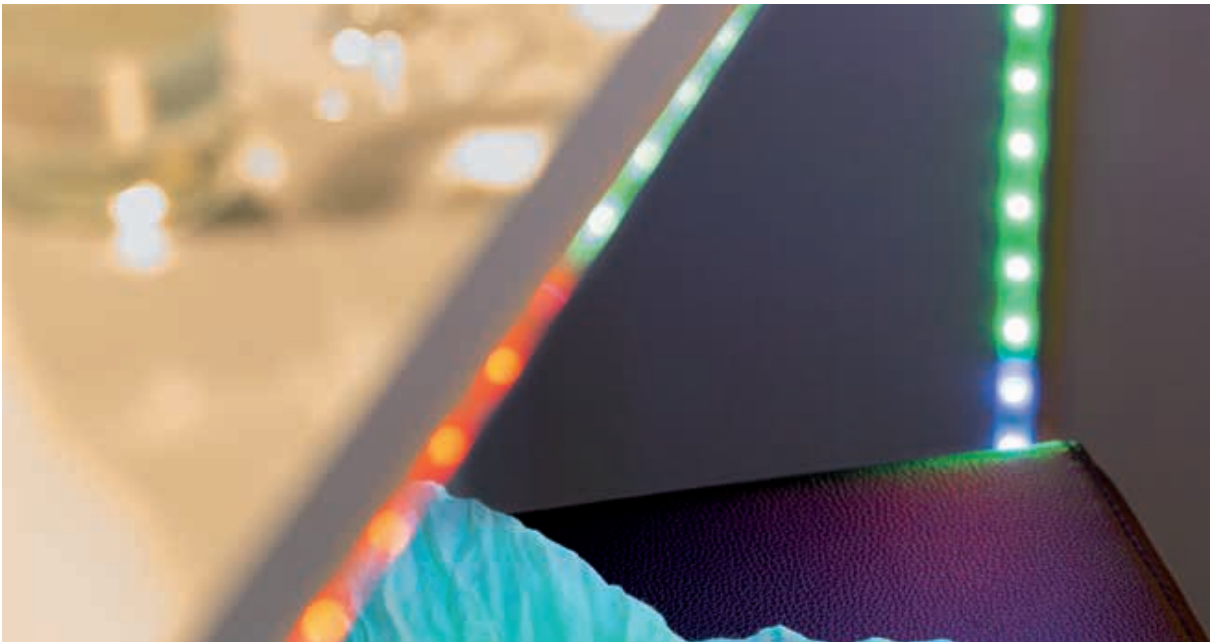

- ▶ LED Stripe set with 164 functions for a range of different light effects, can be shortened electronically
  - ▶ The digital control allows colours to be mixed in dynamic rhythms
  - ▶ Can be dimmed or switched on or off by remote control.
  - ▶ 3 LEDs can be disconnected from the strip end in segments. This allows the strip to be installed in a range of locations at the appropriate length.
- ▶ Juego de regleta LED electrónica acortable con 164 funciones para diversos efectos lumínicos
  - ▶ El control digital permite mezclar colores a ritmos dinámicos
  - ▶ Conmutable y regulable por mando a distancia.
  - ▶ Desde el extremo de la regleta se pueden desconectar 3 LED por segmento. Así se puede colocar la regleta en la longitud adecuada en distintos lugares.
- ▶ Set di strisce LED accorciabili con 164 funzioni per molteplici effetti di luce
  - ▶ Il sistema di comando digitale consente di miscelare i colori con ritmi dinamici
  - ▶ Commutabile e regolabile tramite telecomando.
  - ▶ Dalle estremità delle strisce è possibile disinserire 3 LED per segmento. In questo modo la striscia può essere utilizzata in diversi punti con una lunghezza differente.



- 🔊 White 📊 Plastic
- 🔊 Blanco 📊 Plástico
- 🔊 Bianco 📊 Plastica



**Digital LED Strip Motion Color Set 3m**

A++-A

incl. 1x9,6W  
165 lm  
230/12V, incl. ⚡ 18 VA  
⌀3 mm ↗10,5 mm ↔3 m  
EAN 4000870 704813  
**704.81** 📦



**Digital LED Strip Motion Color Set 5m**

A++-A

incl. 1x14 W  
275 lm  
230/12V, incl. ⚡ 24 VA  
⌀3 mm ↗10,5 mm ↔5 m  
EAN 4000870 704806  
**704.80** 📦

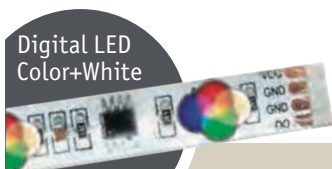

- 🔊 White 📊 Plastic
- 🔊 Blanco 📊 Plástico
- 🔊 Bianco 📊 Plastica

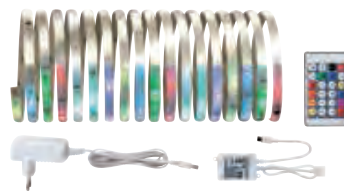

**Digital LED Strip Motion Color+White Set 3m**

A++-A

incl. 1x11,8W  
1.280 lm, 3.000K  
230/12V, incl. ⚡ 24 VA  
⌀3 ↔3.050 ↗10 mm  
EAN 4000870 706961  
**706.96** 📦



**Digital LED Strip Motion Color+White Set 5m**

A++-A

incl. 1x18,8W  
2.050 lm, 3.000K  
230/12V, incl. ⚡ 24 VA  
⌀3 ↔4.880 ↗10 mm  
EAN 4000870 706978  
**706.97** 📦





⌘ White 

--	--	--	--

 Metal/Plastic  
 ⌘ Blanco 

--	--	--	--

 Metal/Plástico  
 ⌘ Bianco 

--	--	--	--

 Metallo/Plastica

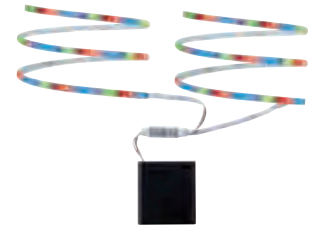
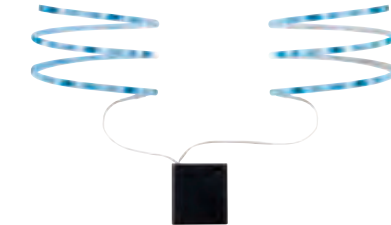
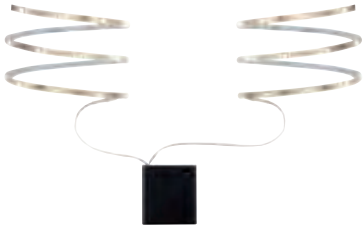
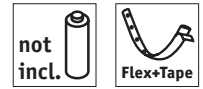

**Mobil Strip (4x1,5V AA excl.)**

incl. 2x0,9W  
 2x95 lm, 2.700 K  
 AA/1,5 V (Mignon) x 4  
 ⌀3 ⇄800 ⌀5 mm  
 EAN 4000870 707012  
**707.01**



**Mobil Strip Blue (4x1,5V AA excl.)**

incl. 2x0,6 W  
 2x8 lm  
 AA/1,5 V (Mignon) x 4  
 ⌀3 ⇄800 ⌀5 mm  
 EAN 4000870 707029  
**707.02**



**Mobil Strip RGB (4x1,5V AA excl.)**

incl. 2x1,2 W  
 2x28 lm  
 AA/1,5 V (Mignon) x 4  
 ⌀3 ⇄800 ⌀5 mm  
 EAN 4000870 707005  
**707.00**

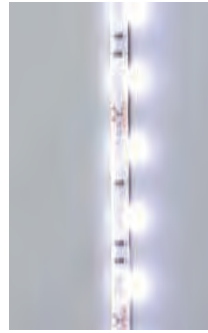

⌘ White 

--	--	--	--

 Metal/Plastic  
 ⌘ Blanco 

--	--	--	--

 Metal/Plástico  
 ⌘ Bianco 

--	--	--	--

 Metallo/Plastica



**USB-Strip Daylight 30cm**

incl. 1x1,5 W  
 60 lm, 6.000 K  
 ⌀2,5 ⇄300 ⌀5 mm  
 EAN 4000870 704554  
**704.55**



**USB-Strip Blue 30cm**

incl. 1x1,5 W  
 ⌀3 ⇄300 ⌀5 mm  
 EAN 4000870 704561  
**704.56**



**USB-Strip Green/White 30cm**

incl. 1x1,5 W  
 ⌀2,5 ⇄300 ⌀5 mm  
 EAN 4000870 707043  
**707.04**



**USB-Strip Red/White 30cm**

incl. 1x1,5 W  
 ⌀3 ⇄300 ⌀5 mm  
 EAN 4000870 704578  
**704.57**



**USB-Strip Blue/White 30cm**

incl. 1x1,5 W  
 ⌀2,5 ⇄300 ⌀5 mm  
 EAN 4000870 707036  
**707.03**



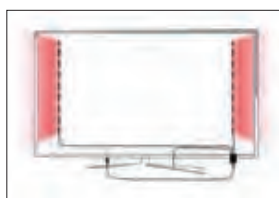

USB-Stripe

- 🌀 Black 🗪 Metal/Plastic
- 🌀 Negro 🗪 Metal/Plástico
- 🌀 Nero 🗪 Metallo/Plastica



**USB-Strip RGB 2x50cm**

incl. 2x1,25 W  
 2x40 lm  
 ✎ 120°  
 ⌀3 ⇄500 ⚡10 mm  
 EAN 4000870 707067  
**707.06**

A++-A

LED



USB-Stripe

- 🌀 Black 🗪 Metal/Plastic
- 🌀 Negro 🗪 Metal/Plástico
- 🌀 Nero 🗪 Metallo/Plastica



**USB-Strip Warm white 2x50cm**

incl. 2x1 W  
 2x60 lm, 3.000 K  
 ⌀3 ⇄500 ⚡10 mm  
 EAN 4000870 707050  
**707.05**

A++-A

LED



## SimpLED



- 🔗 Black 📏 Metal/Plastic
- 🔗 Negro 📏 Metal/Plástico
- 🔗 Nero 📏 Metallo/Plastica



**SimpLED RGB 5m** A++-A

incl. 1x20 W  
505 lm  
230/12 V, incl. ⚡ 24 VA  
⌀3 mm ⌀8 mm ⇄5 m  
EAN 4000870 789780  
**789.78** 📦 **new**













**SimpLED RGB 7,5m** A++-A

incl. 1x26 W  
760 lm  
230/12 V, incl. ⚡ 36 VA  
⌀3 mm ⌀8 mm ⇄7,5 m  
EAN 4000870 789797  
**789.79** 📦 **new**















**SimpLED RGB 10m** A++-A

incl. 1x28 W  
1.010 lm  
230/12 V, incl. ⚡ 36 VA  
⌀3 mm ⌀8 mm ⇄10 m  
EAN 4000870 789803  
**789.80** 📦 **new**





🌀 White 🟩 Metal/Plastic  
 🌀 Blanco 🟩 Metal/Plástico  
 🌀 Bianco 🟩 Metallo/Plastica

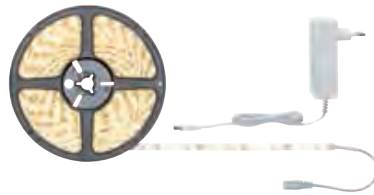

#### SimpLED Warm white 5m

incl. 1×17 W  
 960 lm, 3.000 K  
 230/12 V, incl. ⚡ 18 VA  
 ⌀3 mm ⌀8 mm ⇄5 m  
 EAN 4000870 789728  
**789.72** 📦 **new**

A++-A

LED



#### SimpLED Warm white 7,5m

incl. 1×20 W  
 1.440 lm, 3.000 K  
 230/12 V, incl. ⚡ 24 VA  
 ⌀3 mm ⌀8 mm ⇄7,5 m  
 EAN 4000870 789735  
**789.73** 📦 **new**

A++-A

LED



#### SimpLED Warm white 10m

incl. 1×22 W  
 1.920 lm, 3.000 K  
 230/12 V, incl. ⚡ 36 VA  
 ⌀3 mm ⌀8 mm ⇄10 m  
 EAN 4000870 789742  
**789.74** 📦 **new**

A++-A

LED



🌀 White 🟩 Metal/Plastic  
 🌀 Blanco 🟩 Metal/Plástico  
 🌀 Bianco 🟩 Metallo/Plastica

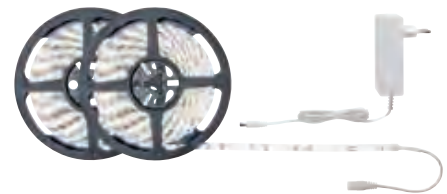
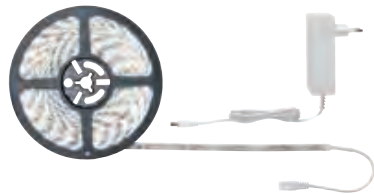

#### SimpLED Daylight 5m

incl. 1×17 W  
 935 lm, 6.500 K  
 230/12 V, incl. ⚡ 18 VA  
 ⌀3 mm ⌀8 mm ⇄5 m  
 EAN 4000870 789759  
**789.75** 📦 **new**

A++-A

LED



#### SimpLED Daylight 7,5m

incl. 1×20 W  
 1.402 lm, 6.500 K  
 230/12 V, incl. ⚡ 24 VA  
 ⌀3 mm ⌀8 mm ⇄7,5 m  
 EAN 4000870 789766  
**789.76** 📦 **new**

A++-A

LED



#### SimpLED Daylight 10m

incl. 1×22 W  
 1.870 lm, 6.500 K  
 230/12 V, incl. ⚡ 36 VA  
 ⌀3 mm ⌀8 mm ⇄10 m  
 EAN 4000870 789773  
**789.77** 📦 **new**

A++-A

LED



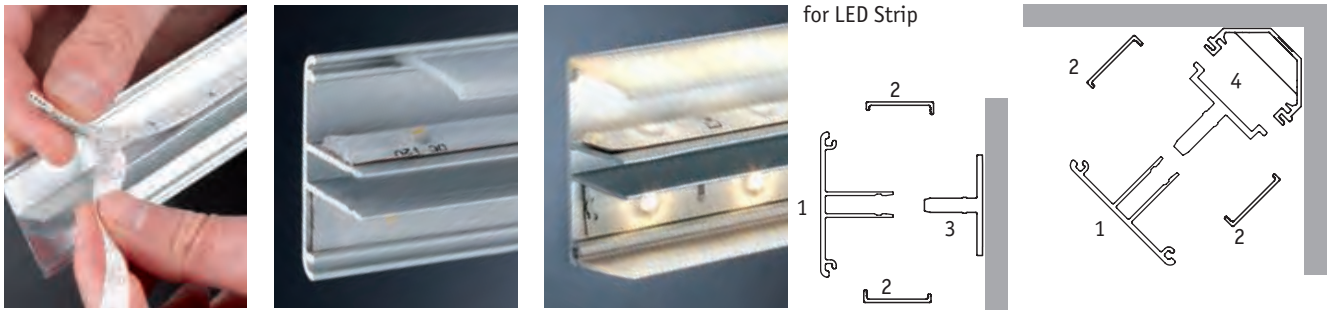

- ▶ High-quality double-T profile made of aluminium with anodised finish – for two-sided light effects
  - ▶ For varied lighting with the YourLED Strip system
  - ▶ Decorative light for presentation of living spaces
  - ▶ Optional diffuser for uniform light distribution
  - ▶ For wall, ceiling or corner mounting
  - ▶ Vielseitiges Zubehör für die Verlegung und Profilabschlüsse
  - ▶ Including cable guides
  - ▶ Positive cooling effect for LED Strips
- ▶ Perfil de gran calidad de doble T en aluminio con superficie anodizada – para efectos lumínicos bilaterales
  - ▶ Para una iluminación versátil con el sistema de regletas YourLED
  - ▶ Iluminación decorativa para una puesta en escena de espacios habitables
  - ▶ Difusor opcional para una distribución uniforme de la luz
  - ▶ Para instalación en pared, techo o esquinas
  - ▶ Accesorios versátiles para el tendido y perfiles embellecedores
  - ▶ Incl. guía para cables
  - ▶ Positivo efecto refrescante para regletas de LEDs
- ▶ Profilato a doppia T di qualità in alluminio con superficie anodizzata - per effetti di luce su due lati
  - ▶ Per l'illuminazione versatile con il sistema YourLED Stripe
  - ▶ Luce decorativa per l'allestimento luminoso degli spazi abitativi
  - ▶ Diffusore opzionale per la distribuzione omogenea della luce
  - ▶ Per il montaggio a parete, a soffitto o ad angolo
  - ▶ Molteplici accessori per la posa e la chiusura dei profilati
  - ▶ Comprensivo di canalina per cavi
  - ▶ Effetto positivo rinfrescante delle strisce LED

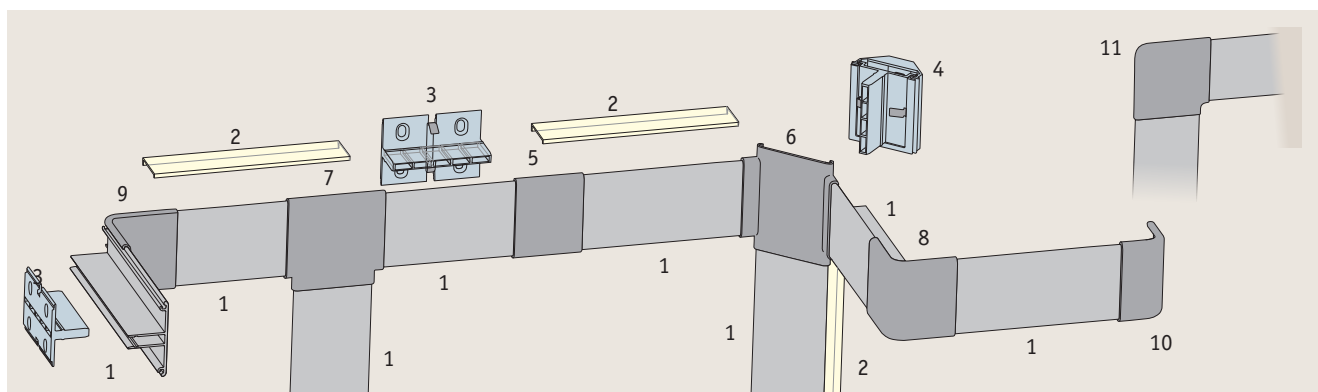

**Duo Profil 1m**

↑40 mm ↗20 mm ↔1 m  
EAN 4000870 702680

**702.68** ⇄

- ↳ Aluminium ▣ Aluminium
- ↳ Aluminio ▣ Aluminio
- ↳ Alluminio ▣ Alluminio



**Duo Profil 2m**

↑40 mm ↗20 mm ↔2 m  
EAN 4000870 702673

**702.67** ⇄

- ↳ Aluminium ▣ Aluminium
- ↳ Aluminio ▣ Aluminio
- ↳ Alluminio ▣ Alluminio



**Duo Profil Diffusor**

↑4 mm ↗20 mm ↔2 m  
EAN 4000870 702697

**702.69** ⇄

- ↳ Satin ▣ Plastic
- ↳ Satinado ▣ Plástico
- ↳ Satinato ▣ Plastica



**Duo Profil Fixture**

↑36 ↔50 ↗21 mm  
EAN 4000870 702758

**702.75** ⇄

- ↳ Transparent ▣ Plastic
- ↳ Transparente ▣ Plástico
- ↳ Trasparente ▣ Plastica



**Duo Profil Clix**

↑40 ↔36 ↗37 mm  
EAN 4000870 702215

**702.21** ⇄

- ↳ Transparent ▣ Plastic
- ↳ Transparente ▣ Plástico
- ↳ Trasparente ▣ Plastica

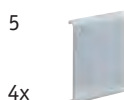

**Duo Profil Cover**

↑42 ↔35 ↗5 mm  
EAN 4000870 702703

**702.70** ⇄

- ↳ Matt aluminium ▣ Plastic
- ↳ Aluminio mate ▣ Plástico
- ↳ Alluminio opaco ▣ Plastica



**Duo Profil X-Cover**

↑55 ↔55 ↗10 mm  
EAN 4000870 703304

**703.30** ⇄

- ↳ Matt aluminium ▣ Plastic
- ↳ Aluminio mate ▣ Plástico
- ↳ Alluminio opaco ▣ Plastica



**Duo Profil T-Cover**

↑49 ↔50 ↗5 mm  
EAN 4000870 702710

**702.71** ⇄

- ↳ Matt aluminium ▣ Plastic
- ↳ Aluminio mate ▣ Plástico
- ↳ Alluminio opaco ▣ Plastica



**Duo Profil Outside Corner**

↑42 ↔35 ↗35 mm  
EAN 4000870 702734

**702.73** ⇄

- ↳ Matt aluminium ▣ Plastic
- ↳ Aluminio mate ▣ Plástico
- ↳ Alluminio opaco ▣ Plastica



**Duo Profil Inside Corner**

↑42 ↔39 ↗39 mm  
EAN 4000870 702727

**702.72** ⇄

- ↳ Matt aluminium ▣ Plastic
- ↳ Aluminio mate ▣ Plástico
- ↳ Alluminio opaco ▣ Plastica



**Duo Profil End Cap**

↑42 ↔22 ↗24 mm  
EAN 4000870 702741

**702.74** ⇄

- ↳ Matt aluminium ▣ Plastic
- ↳ Aluminio mate ▣ Plástico
- ↳ Alluminio opaco ▣ Plastica

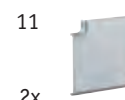

**Duo Profil 90° Corner**

↑20 ↔60 ↗60 mm  
EAN 4000870 704530

**704.53** ⇄

- ↳ Matt aluminium ▣ Plastic
- ↳ Aluminio mate ▣ Plástico
- ↳ Alluminio opaco ▣ Plastica



702.64 + 702.62

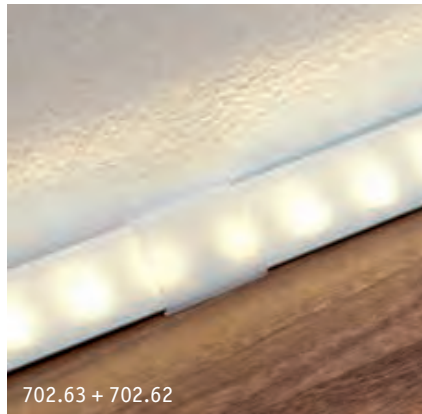

702.63 + 702.62



702.74 + 702.65

- ▶ High-quality angle profile made of aluminium with anodised finish including diffusor
- ▶ For varied lighting with the YourLED Strip system
- ▶ Decorative light for presentation of baseboards or closing edges
- ▶ Additional lighting for utility spaces or under cabinets
- ▶ Orientation and guide lights at shadow and danger zones
- ▶ Vielseitiges Zubehör für die Verlegung und Profilabschlüsse
- ▶ Also usable as continuous lighting by employing economical LED Strips
- ▶ Positive cooling effect for LED Strips

- ▶ Perfil en ángulo de gran calidad en aluminio con superficie anodizada – incluido difusor
- ▶ Para una iluminación versátil con el sistema de regletas YourLED
- ▶ Iluminación decorativa para una puesta en escena de rodapiés o remates de esquinas
- ▶ Iluminación adicional de superficies útiles o bajo armarios
- ▶ Luz de orientación y de guía para zonas en penumbra o peligrosas
- ▶ Accesorios versátiles para el tendido y perfiles embellecedores
- ▶ El empleo de regletas de LEDs de bajo consumo permite también su utilización como iluminación permanente
- ▶ Positivo efecto refrescante para regletas de LEDs

- ▶ Profilato angolare di qualità in alluminio con superficie anodizzata con diffusore
- ▶ Per l'illuminazione versatile con il sistema YourLED Stripe
- ▶ Luce decorativa per l'allestimento luminoso di battiscopa o di bordi di chiusura
- ▶ Illuminazione aggiuntiva di superfici utili o di sottopensili
- ▶ Luce direzionale e di orientamento per le zone d'ombra o le aree pericolose
- ▶ Molteplici accessori per la posa e la chiusura dei profilati
- ▶ Utilizzabile anche per l'illuminazione costante grazie all'impiego delle strisce di LED a basso consumo energetico
- ▶ Effetto positivo rinfrescante delle strisce LED

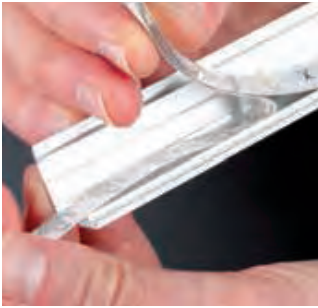

for LED Strip

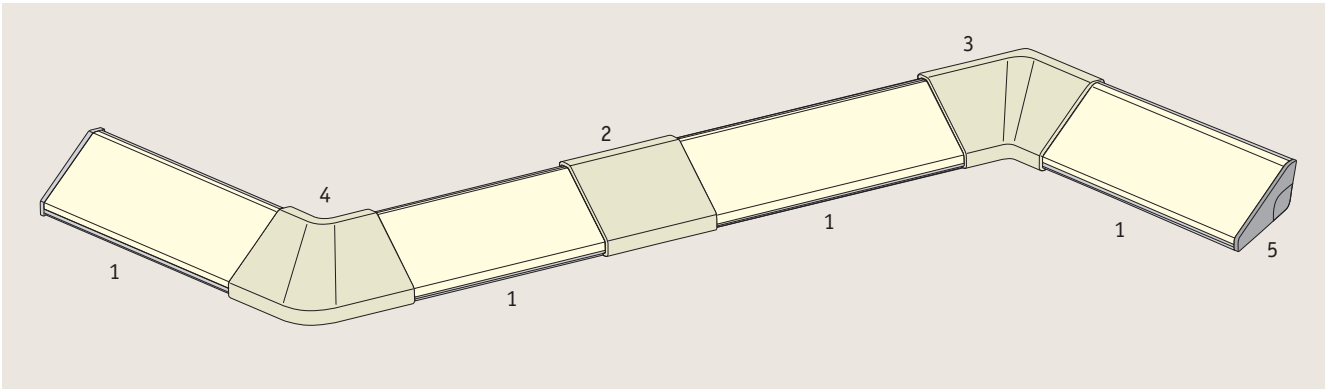
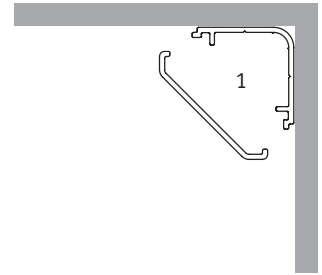

**Delta Profil incl. diffuser 1m**  
 ⌀20 mm ⌀20 mm ⇄1 m  
 EAN 4000870 702628  
**702.62**   
 ⌘ Aluminium/Satin ⌘ Aluminium/Plastic  
 ⌘ Aluminio/Satinado ⌘ Aluminio/Plástico  
 ⌘ Alluminio/Satinato ⌘ Alluminio/Plastica



**Delta Profil incl. diffuser 2m**  
 ⌀20 mm ⌀20 mm ⇄2 m  
 EAN 4000870 702611  
**702.61**   
 ⌘ Aluminium/Satin ⌘ Aluminium/Plastic  
 ⌘ Aluminio/Satinado ⌘ Aluminio/Plástico  
 ⌘ Alluminio/Satinato ⌘ Alluminio/Plastica



**Delta Profil Cover**  
 ⌀29 ⇄35 ⌀5 mm  
 EAN 4000870 702635  
**702.63**   
 ⌘ Satin ⌘ Plastic  
 ⌘ Satinado ⌘ Plástico  
 ⌘ Satinato ⌘ Plastica



**Delta Profil Inside Corner**  
 ⌀21 ⇄35 ⌀35 mm  
 EAN 4000870 702642  
**702.64**   
 ⌘ Satin ⌘ Plastic  
 ⌘ Satinado ⌘ Plástico  
 ⌘ Satinato ⌘ Plastica



**Delta Profil Outside Corner**  
 ⌀21 ⇄35 ⌀35 mm  
 EAN 4000870 702659  
**702.65**   
 ⌘ Satin ⌘ Plastic  
 ⌘ Satinado ⌘ Plástico  
 ⌘ Satinato ⌘ Plastica



**Delta Profil End Cap**  
 ⌀20 ⇄8 ⌀20 mm  
 EAN 4000870 702666  
**702.66**   
 ⌘ Matt aluminium ⌘ Plastic  
 ⌘ Aluminio mate ⌘ Plástico  
 ⌘ Alluminio opaco ⌘ Plastica





⌘ Aluminium/Satin ⌘ Aluminium/Plastic  
 ⌘ Aluminio/Satinado ⌘ Aluminio/Plástico  
 ⌘ Alluminio/Satinato ⌘ Alluminio/Plastica

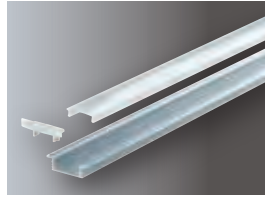

for LED Strip

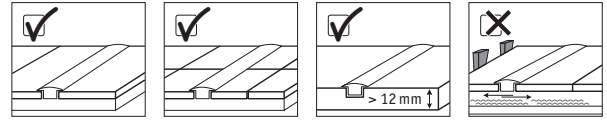

- ▶ Recessed profile for illumination with LED strips creates attractive lighting effects. Can also be used as orientation and guide lights at shadow and danger zones.
- ▶ High-quality aluminium profile with satinised cover on which it is safe to walk (can withstand up to 130 kg)
- ▶ Uniform light distribution.
- ▶ Can be installed in milled grooves on materials with a thickness of 12 mm or more or can be permanently glued to laminate flooring, tiles and carpets.
- ▶ Incl. end caps
- ▶ Not suitable for installation on floating laminate
- ▶ Perfil empotrable para iluminación con regletas de LEDs que crea atractivos efectos de luz. Apto también para usar como luz guía o de orientación.
- ▶ Perfil de aluminio de excelente calidad con cubierta resistente a la pisada (hasta 130 kg)
- ▶ Distribución lumínica uniforme.
- ▶ Para integrar en materiales a partir de 12 mm de grosor o para pegar de forma fija en baldosas, moquetas o suelos laminados.
- ▶ Incluye molduras de cierre
- ▶ No apto para suelos laminados flotantes
- ▶ Profilo da incasso per illuminazione con strisce di LED, per creare affascinanti effetti luminosi. Utilizzabile anche come luce direzionale o di orientamento.
- ▶ Profilato in alluminio di alta qualità con copertura calpestabile (130 kg max.)
- ▶ Distribuzione omogenea della luce.
- ▶ Per montaggio a incasso in materiali a partire da 12 mm di spessore o per incollaggio permanente su laminato, piastrelle e moquette.
- ▶ Calotte terminali incluse
- ▶ Non adatto per il montaggio su laminato galleggiante



**Floor Profil 1m**

⌘9 ⇔1.010 ⌘27 mm  
 EAN 4000870 704103  
**704.10**



**Floor Profil 2m**

⌘9 ⇔2.010 ⌘27 mm  
 EAN 4000870 704097  
**704.09**





- 🌀 Grey 🏠 Plastic
- 🌀 Gris 🏠 Plástico
- 🌀 Grigio 🏠 Plastica

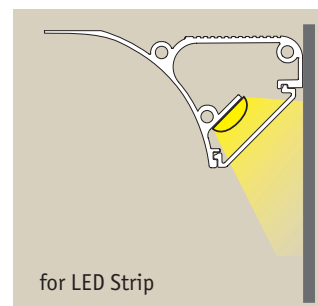

- ▶ Decorative ceiling profile for shining indirect light onto the wall with LED strips.
- ▶ Uniform light distribution.
- ▶ End caps for straight wall cuts included in scope of supply
- ▶ Inner and outer corners available as accessories
- ▶ Outer corners can also be used as start and end points on straight sections.
- ▶ Can be fastened with customary construction adhesives
- ▶ For laying LED strips and cable connections.

- ▶ Decorativo perfil de techo para iluminación indirecta de la pared con regletas de LEDs.
- ▶ Distribución lumínica uniforme.
- ▶ Se suministra junto con molduras de cierre para secciones de pared rectas
- ▶ Rinconeros y esquineros disponibles como accesorios
- ▶ Los esquineros pueden usarse igualmente como punto inicial o final en tramos rectos.
- ▶ Fijación mediante adhesivos de construcción comerciales
- ▶ Para el tendido de regletas de LEDs y conectores de cables.

- ▶ Profilo decorativo per soffitto per l'illuminazione indiretta di pareti con strisce a LED.
- ▶ Distribuzione omogenea della luce.
- ▶ Calotte terminali incluse nel volume di consegna per montaggio anche a metà parete
- ▶ Angoli interni ed esterni disponibili come accessori
- ▶ Angoli esterni utilizzabili anche come elemento iniziale o finale su un tratto rettilineo.
- ▶ Fissaggio con adesivi da costruzione comunemente in commercio
- ▶ Per la posa di strisce di LED e connettori per cavi.



#### Corner Profil 1m

⌀31,5 mm ⌘49 mm ⇄1 m  
EAN 4000870 704400  
**704.40** 📦

#### Corner Profil 2m

⌀31,5 mm ⌘49 mm ⇄2 m  
EAN 4000870 704394  
**704.39** 📦

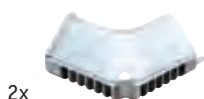

2x

#### Corner Profil Inside Edge

⌀31,5 ⇄59 ⌘59 mm  
EAN 4000870 704424  
**704.42** 📦

- 🌀 Grey 🏠 Plastic
- 🌀 Gris 🏠 Plástico
- 🌀 Grigio 🏠 Plastica



2x

#### Corner Profil Outside Edge

⌀31,5 ⇄49 ⌘49 mm  
EAN 4000870 704417  
**704.41** 📦

- 🌀 Grey 🏠 Plastic
- 🌀 Gris 🏠 Plástico
- 🌀 Grigio 🏠 Plastica



for LED Strip

⌘ Aluminium/Satin ⌘ Aluminium/Plastic  
 ⌘ Aluminio/Satinado ⌘ Aluminio/Plástico  
 ⌘ Alluminio/Satinato ⌘ Alluminio/Plastica



**Square Profil incl. Diffusor 1m**

⌀15 mm ⌀23 mm ⇔1 m  
 EAN 4000870 708095  
**708.09** **new**



**Square Profil incl. Diffusor 2m**

⌀15 mm ⌀23 mm ⇔2 m  
 EAN 4000870 708101  
**708.10** **new**



for LED Strip

⌘ Transparent ⌘ Plastic  
 ⌘ Transparente ⌘ Plástico  
 ⌘ Trasparente ⌘ Plastica

- ▶ Decorative light for display cases and glass edgings
- ▶ For illumination of glass shelves of any length with YourLED Stripes
- ▶ Suitable for glass thicknesses of 4-8 mm
- ▶ Easily fitted: Strip inserted and plugged on the back edges of the glass shelves

- ▶ Iluminación decorativa para vitrinas y estantes de cristal
- ▶ Para la iluminación de suelos de cristal de cualquier longitud con regletas YourLED
- ▶ Adecuada para grosores de cristal de 4-8 mm
- ▶ Montaje simple: Encaje la regleta acoplando el dorso al suelo de cristal

- ▶ Luce decorativa per vetrine e ripiani in vetro
- ▶ Per l'illuminazione di ripiani in vetro della lunghezza desiderata con YourLED Stripes
- ▶ Adatto per vetri con spessore di 4-8 mm
- ▶ Montaggio semplice: basta posare la striscia e montarla sul bordo posteriore dei ripiani in vetro



**BackLight Profil 1m**

⌀13 mm ⌀19 mm ⇔1 m  
 EAN 4000870 702833  
**702.83**



- ⌘ Anodised aluminium/Satin ⌘ Aluminium/Plastic
- ⌘ Aluminio anodizado/Satinado ⌘ Aluminio/Plástico
- ⌘ Alluminio anodizzato/Satinato
- ⌘ Alluminio/Plastica



for LED Strip



**Step Profil incl. Diffusor 1m**

⌀60 mm ⇔ 1 m  
 EAN 4000870 708552  
**708.55**  **new**

**Step Profil incl. Diffusor 2m**

⌀60 mm ⇔ 2 m  
 EAN 4000870 708569  
**708.56**  **new**



- 🌀 Anodised aluminium/Satin 🗪 Aluminium/Plastic
- 🌀 Aluminio anodizado/Satinado 🗪 Aluminio/Plástico
- 🌀 Alluminio anodizzato/Satinato 🗪 Alluminio/Plastica

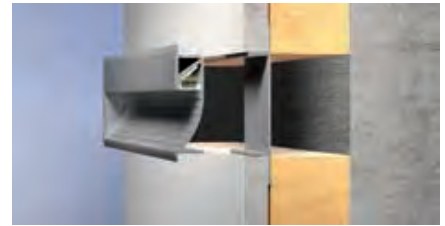

for LED Strip



**Cup Profil incl. Diffusor 1m**

⌀55,1 mm ⌀14 mm ⇔1 m  
 EAN 4000870 708583  
**708.58** 🗪 **new**

**Cup Profil incl. Diffusor 2m**

⌀55,1 mm ⌀14 mm ⇔2 m  
 EAN 4000870 708590  
**708.59** 🗪 **new**





- 🔗 Anodised aluminium/Satin 🗪 Aluminium/Plastic
- 🔗 Aluminio anodizado/Satinado 🗪 Aluminio/Plástico
- 🔗 Alluminio anodizzato/Satinato 🗪 Alluminio/Plastica



for LED Strip



**Socle Profil incl. Diffusor 1m**

⌀35 mm ⌀12,5 mm ⇄1 m  
 EAN 4000870 708620  
**708.62** 📦 **new**

**Socle Profil incl. Diffusor 2m**

⌀35 mm ⌀12,5 mm ⇄2 m  
 EAN 4000870 708637  
**708.63** 📦 **new**



⚙ Anodised aluminium/Satin   Aluminium/  
 Plastic  
 ⚙ Aluminio anodizado/Satinado   Aluminio/  
 Plástico  
 ⚙ Alluminio anodizzato/Satinato  
  Alluminio/Plastica



for LED Strip



**Deep Profil incl. Diffusor 1m**

⚙22,5 mm ⚙24,9 mm ⇔1 m  
 EAN 4000870 708606  
**708.60**   **new**

**Deep Profil incl. Diffusor 2m**

⚙22,5 mm ⚙24,9 mm ⇔2 m  
 EAN 4000870 708613  
**708.61**   **new**



**Deep Profil Fixture**

⚙76 ⚙11,8 mm  
 EAN 4000870 708576  
**708.57**   **new**  
 ⚙ Silver   Aluminium  
 ⚙ Plateado   Aluminio  
 ⚙ Argento   Alluminio



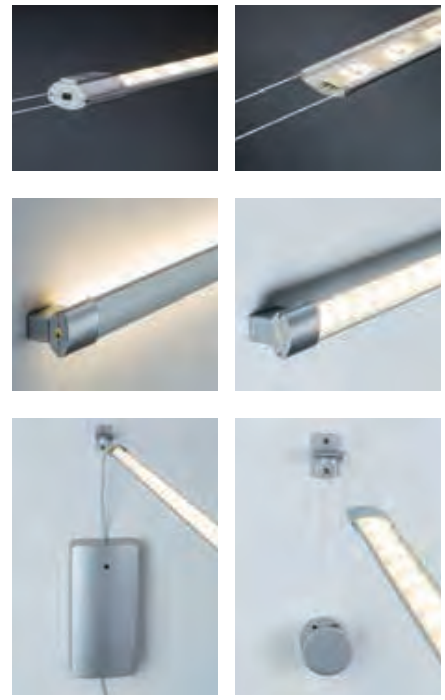

**Flying Strip Set** A++-A

incl. 1x26,5 W  
 900 lm  
 <math>\sphericalangle 120^\circ</math>  
 230/12 V, incl. <math>\pm 48\text{ VA}</math>  
 <math>25\text{ mm}</math> <math>3\text{ mm}</math> <math>10,5\text{ mm}</math> <math>6\text{ m}</math>  
 EAN 4000870 707173  
**707.17** **new**

Black/Aluminium Plastic  
 Negro/Aluminio Plástico  
 Nero/Alluminio Plastica

**Flying Strip Set** A++-A

incl. 1x14 W  
 1200 lm, 3.000 K  
 <math>\sphericalangle 120^\circ</math>  
 230/12 V, incl. <math>\pm 15\text{ VA}</math>  
 <math>25\text{ mm}</math> <math>3\text{ mm}</math> <math>10,5\text{ mm}</math> <math>6\text{ m}</math>  
 EAN 4000870 707166  
**707.16** **new**

White/Aluminium Plastic  
 Blanco/Aluminio Plástico  
 Bianco/Alluminio Plastica



**Flying Profil**

<math>25\text{ mm}</math> <math>11\text{ mm}</math> <math>28\text{ mm}</math> <math>2\text{ m}</math>  
 EAN 4000870 707159  
**707.15** **new**

Anodised aluminium/Satin Aluminium/Plastic  
 Aluminio anodizado/Satinado Aluminio/Plástico  
 Alluminio anodizzato/Satinato Alluminio/Plastica

**Wall-mounted Flying Profil**

<math>25</math> <math>33</math> <math>30</math> <math>35\text{ mm}</math>  
 EAN 4000870 707197  
**707.19** **new**

Aluminium Plastic  
 Aluminio Plástico  
 Alluminio Plastica

**Flying Profil Diverter**

<math>25</math> <math>43</math> <math>27</math> <math>37\text{ mm}</math>  
 EAN 4000870 707180  
**707.18** **new**

Aluminium Aluminium  
 Aluminio Aluminio  
 Alluminio Alluminio



- 🌀 Silver 📦 Plastic
- 🌀 Plateado 📦 Plástico
- 🌀 Argento 📦 Plastica

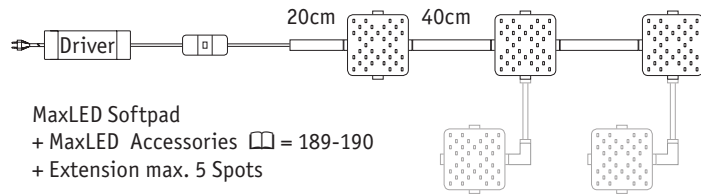

MaxLED Softpad  
 + MaxLED Accessories 📦 = 189-190  
 + Extension max. 5 Spots



**MaxLED Softpad**

incl. 3x6,6 W  
 3x572 lm, 2.700 K  
 230/24 V, incl. ⚡ 36 VA  
 ⚡3 ↔220 ⚡65 mm  
 EAN 4000870 707098  
**707.09** 📦 **new**

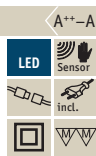

**MaxLED Softpad**

incl. 3x3,3 W  
 3x288 lm, 2.700 K  
 230/24 V, incl. ⚡ 20 VA  
 ⚡3 ↔85 ⚡85 mm  
 EAN 4000870 707104  
**707.10** 📦 **new**

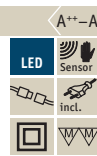

**MaxLED Softpad**

incl. 3x2,8 W  
 3x240 lm, 2.700 K  
 230/24 V, incl. ⚡ 15 VA  
 ⚡3 ø85 mm  
 EAN 4000870 707111  
**707.11** 📦 **new**

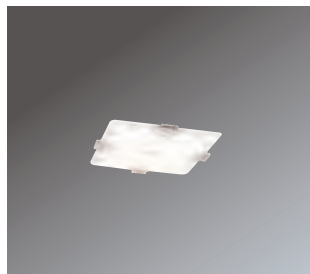
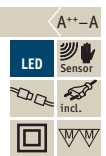

**MaxLED Softpad**

incl. 1x6,6 W  
 572 lm, 2.700 K  
 24 V  
 ⚡3 ↔220 ⚡65 mm  
 EAN 4000870 707128  
**707.12** 📦 **new**



**MaxLED Softpad**

incl. 1x3,3 W  
 288 lm, 2.700 K  
 24 V  
 ⚡3 ↔85 ⚡85 mm  
 EAN 4000870 707135  
**707.13** 📦 **new**



**MaxLED Softpad**

incl. 1x2,8 W  
 240 lm, 2.700 K  
 24 V  
 ⚡3 ø85 mm  
 EAN 4000870 707142  
**707.14** 📦 **new**



- 🌀 Silver 📦 Plastic
- 🌀 Plateado 📦 Plástico
- 🌀 Argento 📦 Plastica

- 🌀 Silver 📦 Plastic
- 🌀 Plateado 📦 Plástico
- 🌀 Argento 📦 Plastica

- 🌀 Silver 📦 Plastic
- 🌀 Plateado 📦 Plástico
- 🌀 Argento 📦 Plastica

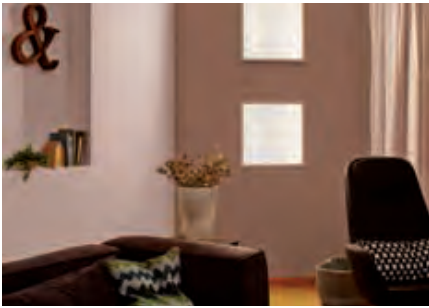

⌘ Satin/White ⌘ Aluminium/Glass  
 ⌘ Satinado/Blanco ⌘ Aluminio/Cristal  
 ⌘ Satinato/Bianco ⌘ Alluminio/Vetro

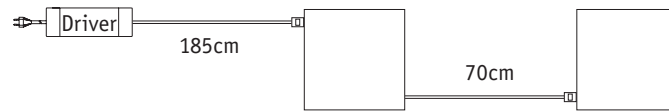

**Lumix**  
 incl. 1x11,5W  
 1.000lm, 2.700K  
 230/24V, incl. ⚡ 36VA  
 ⚡500 ⇄500 ↗10mm  
 EAN 4000870 708132  
**708.13** **new**



**Lumix**  
 incl. 1x11,5W  
 1.000lm, 2.700K  
 24V  
 ⚡500 ⇄500 ↗10mm  
 EAN 4000870 708149  
**708.14** **new**



**Lumix**  
 incl. 1x11,5W  
 1.000lm, 2.700K  
 230/24V, incl. ⚡ 36VA  
 ⚡500 ⇄500 ↗10mm  
 EAN 4000870 708118  
**708.11** **new**



**Lumix**  
 incl. 1x11,5W  
 1.000lm, 2.700K  
 24V  
 ⚡500 ⇄500 ↗10mm  
 EAN 4000870 708125  
**708.12** **new**







- 🌀 White/Satin 🗪 Metal/Plastic
- 🌀 Blanco/Satinado 🗪 Metal/Plástico
- 🌀 Bianco/Satinato 🗪 Metallo/Plastica

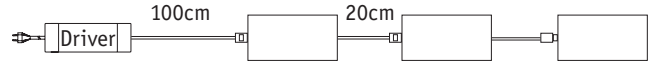

**Glow Basic**

incl. 1x8,0 W  
650 lm, 2.700 K  
230/24 V, incl. ⚡ 24 VA  
⌀250 ⇄400 ⌀7 mm  
EAN 4000870 708071  
**708.07 new**



**Glow Extension**

incl. 1x8,0 W  
650 lm, 2.700 K  
DC 24 V  
⌀250 ⇄400 ⌀7 mm  
EAN 4000870 708088  
**708.08 new**



- 🌀 White/Satin 🗪 Metal/Plastic
- 🌀 Blanco/Satinado 🗪 Metal/Plástico
- 🌀 Bianco/Satinato 🗪 Metallo/Plastica



**Ace Basic**

incl. 1x7,5 W  
580 lm, 2.700 K  
230/24 V, incl. ⚡ 24 VA  
⌀100 ⇄300 ⌀7 mm  
EAN 4000870 707760  
**707.76 new**



**Ace Extension**

incl. 1x7,5 W  
580 lm, 2.700 K  
DC 24 V  
⌀100 ⇄300 ⌀7 mm  
EAN 4000870 707777  
**707.77 new**



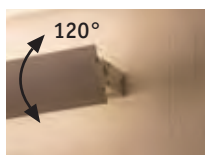

⌘ Anodised aluminium 

--	--	--	--

 Aluminium/Plastic  
 ⌘ Aluminio anodizado 

--	--	--	--

 Aluminio/Plástico  
 ⌘ Alluminio anodizzato 

--	--	--	--

 Alluminio/Plastica



### Swing Kitchen Rail

incl. 1x6,3 W  
 765 lm, 2.700 K  
 ∠ 120°  
 230 V  
 ⌀50 ⇄800 ⌀65 mm  
 EAN 4000870 708262  
**708.26 new**

A++-A

LED

incl.

IP23

--	--	--	--

--	--	--	--

--	--	--	--

On/Off



⌘ Matt aluminium/Black 

--	--	--	--

 Aluminium/Plastic  
 ⌘ Aluminio mate/Negro 

--	--	--	--

 Aluminio/Plástico  
 ⌘ Alluminio opaco/Nero 

--	--	--	--

 Alluminio/Plastica



- ▶ LED cabinet lamp
- ▶ Clear cover with prism effect
- ▶ Super flat, high-quality aluminium profile
- ▶ Incl. touch switch
- ▶ Easily fixed in place with mounting clips
- ▶ Incl. power supply

- ▶ Luminarias de armario de LED
- ▶ Cubierta transparente con efecto prismático
- ▶ Perfil de aluminio extraplano de gran calidad
- ▶ Incl. interruptor táctil
- ▶ Fácil fijación mediante presillas de montaje
- ▶ Incl. fuente de alimentación

- ▶ Illuminazione LED
- ▶ Copertura chiara con effetto prisma
- ▶ Profilo in alluminio di qualità, ultrapiatto
- ▶ Interruttore touch incluso
- ▶ Facile da fissare grazie alle clip di montaggio
- ▶ Alimentazione inclusa

**TriX** A++-A  
 incl. 1x4,2 W  
 340 lm, 3.000 K  
 ∠ 120°  
 230/12 V, incl. ⚡7 VA  
 ⌀12 ⇄465 ⌀65 mm  
 EAN 4000870 703984  
**703.98**

LED



**TriX** A++-A  
 incl. 1x4,8 W  
 420 lm, 3.000 K  
 ∠ 120°  
 230/12 V, incl. ⚡7 VA  
 ⌀12 ⇄565 ⌀65 mm  
 EAN 4000870 704479  
**704.47**

LED



**TriX** A++-A  
 incl. 1x5,7 W  
 520 lm, 3.000 K  
 ∠ 120°  
 230/12 V, incl. ⚡7 VA  
 ⌀12 ⇄765 ⌀65 mm  
 EAN 4000870 704486  
**704.48**

LED





- ↳ Matt aluminium 

 Aluminium/Plastic
- ↳ Aluminio mate 

 Aluminio/Plástico
- ↳ Alluminio opaco 

 Alluminio/Plastica

- ▶ LED drawer light with distance sensor
- ▶ Ideal for lighting drawers and closets
- ▶ Distance sensor switches automatically during opening and closing. Switching distance 5 cm
- ▶ Minimal installation height
- ▶ Easy to mount using slot blocks
- ▶ Luz de cajón de LEDs con sensor de distancia
- ▶ Ideal para iluminar cajones y armarios
- ▶ El sensor de distancia actúa automáticamente al abrir y cerrar el mueble. Distancia de actuación 5 cm
- ▶ Mínima altura de montaje
- ▶ Montaje sencillo: fijación con tacos de corredera
- ▶ Luce LED per cassetti con sensore di prossimità
- ▶ Ideale per l'illuminazione di cassetti e armadi
- ▶ Il sensore di prossimità scatta automaticamente all'apertura/chiusura. Distanza di commutazione 5 cm
- ▶ Minimo spessore di montaggio
- ▶ Semplice fissaggio con elementi a incastro



SenseLight	A++-A	SenseLight	A++-A	SenseLight	A++-A	SenseLight	A++-A
incl. 1x5 W		incl. 1x6,5 W		incl. 1x6,5 W		incl. 1x10 W	
300 lm, 2.700 K		287 lm, 2.700 K		400 lm, 2.700 K		640 lm, 2.700 K	
∠ 120°		∠ 120°		∠ 120°		∠ 120°	
230/12 V, incl. - 7,5 VA		230/12 V, incl. - 7 VA		230/12 V, incl. - 12 VA		230/12 V, incl. - 12 VA	
∅13 ↔300 ↗31 mm		∅13 ↔500 ↗31 mm		∅13 ↔400 ↗31 mm		∅13 ↔600 ↗31 mm	
EAN 4000870 704356		EAN 4000870 703991		EAN 4000870 704431		EAN 4000870 704448	
<b>704.35</b>		<b>703.99</b>		<b>704.43</b>		<b>704.44</b>	



- ↳ Matt aluminium 

 Aluminium/Plastic
- ↳ Aluminio mate 

 Aluminio/Plástico
- ↳ Alluminio opaco 

 Alluminio/Plastica

- ▶ Trimmable LED clothing rack lamp
- ▶ Effortless switching with integrated motion detector
- ▶ High-quality aluminium profile, trimmable with metal saw
- ▶ Incl. soft top for silent gliding of hangers
- ▶ Mounting flange with integrated power supply
- ▶ Luminaria de LED recortable para barra de perchas
- ▶ Cómodo encendido mediante sensor de movimiento integrado
- ▶ Perfil de aluminio de gran calidad recortable con sierra de metal
- ▶ Incl. parte superior blanda para deslizamiento silencioso de las perchas
- ▶ Brida de montaje con pasacorriente integrado
- ▶ Luce LED per asta portabiti accorciabile
- ▶ Grande comodità di accensione e spegnimento con il sensore di movimento integrato
- ▶ Profilo in alluminio di qualità, accorciabile con sega per metallo
- ▶ Morbida striscia superiore inclusa per fare scivolare le grucce senza rumore
- ▶ Flangia di montaggio con alimentazione di corrente integrata

DressLight	A++-A	DressLight	A++-A
incl. 1x6,5 W		incl. 1x11,5 W	
300 lm, 2.700 K		640 lm, 2.700 K	
∠ 120°		∠ 120°	
230/12 V, incl. - 7 VA		230/12 V, incl. - 12 VA	
∅31 ↔600 ↗19 mm		∅31 ↔1.100 ↗19 mm	
EAN 4000870 704035		EAN 4000870 704042	
<b>704.03</b>		<b>704.04</b>	



⌘ Aluminium 

--	--	--	--

 Aluminium/Plastic  
 ⌘ Aluminio 

--	--	--	--

 Aluminio/Plástico  
 ⌘ Alluminio 

--	--	--	--

 Alluminio/Plastica



- ▶ The LED clothing rack light with integrated motion detector can be shortened and makes it easy to get a good overview of the closet contents. Easy installation thanks to battery operation. DressLights can be shortened to the desired cabinet dimensions just like ordinary clothing racks.
- ▶ Operated with 4x1.5V AAA (excl.)
- ▶ Can be shortened to a distance of 10 cm from the sensor
- ▶ Clear cover for protecting the LED
- ▶ Supports evenly distributed loads of max. 20 kg
- ▶ Incl. pole holders
- ▶ La luminaria de LEDs recortable de barra de perchas con sensor de movimiento integrado permite una clara visión en el ropero. Fácil de montar porque funciona a pilas. DressLight se puede recortar a la longitud deseada como cualquier barra de perchas convencional para ropero.
- ▶ Funciona con 4 pilas AAA de 1,5V (no incl.)
- ▶ Recortable hasta a 10 cm de distancia del sensor
- ▶ Cubierta transparente que protege los LEDs
- ▶ Soporta un máximo de 20 kg de peso distribuido uniformemente
- ▶ Incluye soportes de barra de perchas
- ▶ Asta portabiti accorciabile con luce LED e sensore di movimento integrato per un'illuminazione ottimale all'interno dell'armadio. Montaggio semplificato con funzionamento a batteria. La DressLight può essere accorciata come una comune asta portabiti per adattarsi alle dimensioni di ogni armadio.
- ▶ Funzionamento con 4 batterie AAA da 1,5 V (non incluse)
- ▶ Accorciabile fino a 10 cm di distanza dal sensore
- ▶ Copertura trasparente per la protezione dei LED
- ▶ Carico max.: 20 kg con distribuzione uniforme del peso
- ▶ Supporti per asta inclusi

#### DressLight Battery

incl. 1x0,9 W  
 35 lm, 2.700 K  
 ✕ 120°  
 AAA/1,5V (Micro) × 4  
 ⌀30 ⇔600 ↗16 mm  
 EAN 4000870 705018  
**705.01**



#### DressLight Battery

incl. 1x1,35 W  
 58 lm, 2.700 K  
 ✕ 120°  
 AAA/1,5V (Micro) × 4  
 ⌀30 ⇔1.100 ↗16 mm  
 EAN 4000870 704998  
**704.99**





- ▶ Multifunctional battery lights with a range of uses in furniture or beneath hanging cupboards for even working light, directional spot lighting or as a helpful orientation light. Some models can be dimmed, fitted with swivelling spot heads or motion detectors.
  - ▶ Incl. assembly plate for easy battery replacement
  - ▶ Easy to attach using adhesive or velcro pads
- ▶ Lámparas multifuncionales de pilas con multitud de posibilidades de aplicación en muebles o armarios instalados en pared, para una luz de trabajo uniforme, una iluminación directa con focos o como una práctica luz de orientación. Dependiendo del modelo: regulables, con cabezales de foco orientables o con sensores de movimiento.
  - ▶ Incl. placa de montaje para un sencillo cambio de las pilas
  - ▶ Fácil fijación con tiras adhesivas o velcro
- ▶ Luci multifunzione a batteria con diverse possibilità di impiego in mobili o sotto ai pensili per una luce di lavoro omogenea, per un'illuminazione mirata con spot o per l'utile luce di orientamento. A seconda del modello: dimmerabili, equipaggiabili con spot orientabili o sensori di movimento.
  - ▶ Con piastra di montaggio compresa per una semplice sostituzione della batteria
  - ▶ Semplice fissaggio con adesivi o velcro



**Jiggle** A++-A

incl. 3×0,18 W  
 3×22 lm, 3.000 K  
 ✕ 105°  
 AAA/1,5V (Micro) × 6  
 ⚡35 ↔300 ↗60 mm  
 EAN 4000870 706350  
**706.35**

🔗 Chrome matt Plastic  
 🔗 Cromo mate Plástico  
 🔗 Cromo opaco Plastica



**Rotate** A++-A

incl. 3×0,2 W  
 3×18 lm, 3.000 K  
 ✕ 105°  
 AAA/1,5V (Micro) × 6  
 ⚡50 ↔310 ↗60 mm  
 EAN 4000870 706367  
**706.36**

🔗 Anthracite/Chrome matt Plastic  
 🔗 Antracita/Cromo mate Plástico  
 🔗 Antracite/Cromo opaco Plastica



**SmartLight** A++-A

incl. 1x1,6 W  
 140 lm, 3.000 K  
 ✕ 100°  
 ⚙️27 ⇄250 ↗55 mm  
 EAN 4000870 706381

**706.38**

✎ Chrome matt 🗪 Plastic

✎ Cromo mate 🗪 Plástico

✎ Cromo opaco 🗪 Plástica

**LED**

incl.

Sensor

excl.

Accu Battery

On/Off

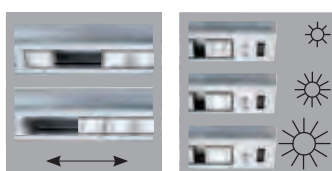
**Slide bar** A++-A

incl. 3x0,5 W  
 3x40 lm, 3.000 K  
 ✕ 20°  
 ⚙️31,5 ⇄304 ↗80 mm  
 EAN 4000870 706404

**706.40**

✎ Chrome matt 🗪 Plastic

✎ Cromo mate 🗪 Plástico

✎ Cromo opaco 🗪 Plástica

**LED**

incl.

excl.

Accu Battery

On/Off

**Rotate** A++-A

incl. 1x1 W  
 66 lm, 3.000 K  
 ✕ 20°  
 ⌀92 ↗72 mm  
 EAN 4000870 706374

**706.37**

✎ Chrome matt 🗪 Plastic

✎ Cromo mate 🗪 Plástico

✎ Cromo opaco 🗪 Plástica

**LED**

incl.

excl.

Accu Battery

On/Off

**ButtonLED** A++-A

incl. 1x0,6 W  
 70 lm, 3.000 K  
 ✕ 105°  
 ⚙️41 ⌀88 mm  
 EAN 4000870 706398

**706.39**

✎ Anthracite 🗪 Plastic

✎ Antracita 🗪 Plástico

✎ Antracite 🗪 Plástica

**LED**

incl.

excl.

Accu Battery

On/Off



🌀 Silver 🗪 Plastic  
 🌀 Plateado 🗪 Plástico  
 🌀 Argento 🗪 Plastica



- ▶ Optimal for sliding doors: Miniature LED light with roller for battery operation. When a cabinet door is opened, the roller automatically switches the light on and off again. Light that is simply there when you need it.
- ▶ Easy installation; simply fasten removable mounting base with adhesive pads or screws
- ▶ Easily accessible battery compartment
- ▶ Operated with 4x1.5V AAA (excl.)
- ▶ Clear cover and reflector for optimised light yield

- ▶ Ideal para puertas correderizas: miniluminarias de LEDs con rueda corredera para usar a pilas. La rueda enciende y apaga automáticamente la luz al abrirse o cerrarse una puerta del ropero. Sencillamente: luz cuando y donde se necesita.
- ▶ Fácil de fijar: base separable que puede fijarse con tornillos o almohadillas adhesivas
- ▶ Compartimento de pilas fácilmente accesible
- ▶ Funciona con 4 pilas AAA de 1,5V (no incl.)
- ▶ Cubierta transparente y reflector para un óptimo rendimiento lumínico

- ▶ Ottima per le porte scorrevoli: miniluce a LED con rullino di scorrimento funzionante a batteria. Il rullino di scorrimento accende automaticamente la luce quando una porta dell'armadio viene aperta, e successivamente torna a spegnerla. Per avere la luce giusta al momento giusto - né più, né meno.
- ▶ Montaggio semplice con base separabile per fissaggio con cuscinetti adesivi o viti
- ▶ Vano batterie facilmente accessibile
- ▶ Funzionamento con 4 batterie AAA da 1,5 V (non incluse)
- ▶ Copertura trasparente e riflettore per una propagazione ottimale della luce

**SnapLED**

incl. 1x0,33 W  
 25 lm, 2.700 K  
 ∠ 120°  
 AAA/1,5V (Micro) × 4  
 ⚡22 ↔53 ↻95 mm  
 EAN 4000870 704981  
**704.98** 📦

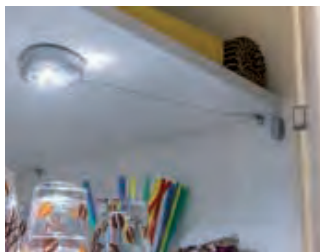

🌀 Aluminium 🗪 Aluminium/Plastic  
 🌀 Aluminio 🗪 Aluminio/Plástico  
 🌀 Alluminio 🗪 Alluminio/Plastica



- ▶ Miniature LED light with magnet contact for battery operation. When a cabinet door is opened, the magnet contact automatically switches the light on and off again. Light that is simply there when you need it.
- ▶ Easy installation with adhesive pads
- ▶ Operated with 3x1.5 V AAA (excl.)
- ▶ Clear cover and reflector for optimised light yield

- ▶ Miniluminarias de LEDs con contacto magnético para usar a pilas. El contacto magnético enciende y apaga automáticamente la luz al abrirse o cerrarse una puerta del ropero. Sencillamente: luz cuando y donde se necesita.
- ▶ Fácil de montar mediante almohadillas adhesivas
- ▶ Funciona con 3 pilas AAA de 1,5V (no incl.)
- ▶ Cubierta transparente y reflector para un óptimo rendimiento lumínico

- ▶ Miniluce a LED con contatto magnetico funzionante a batteria. Il contatto magnetico accende automaticamente la luce quando una porta dell'armadio viene aperta, e successivamente torna a spegnerla. Per avere la luce giusta al momento giusto - né più, né meno.
- ▶ Montaggio semplice con cuscinetti adesivi
- ▶ Funzionamento con 3 batterie AAA da 1,5 V (non incluse)
- ▶ Copertura trasparente e riflettore per una propagazione ottimale della luce

**TriLED**

incl. 1x0,18 W  
 7.400 - 9.400 K  
 ∠ 120°  
 AAA/1,5V (Micro) × 3  
 ⚡24 ↔66 ↻65 mm  
 EAN 4000870 705001  
**705.00** 📦



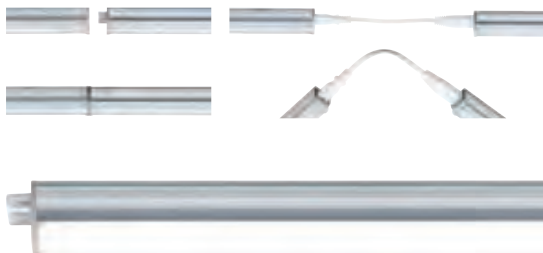

- ↳ Satin Aluminium/Plastic
- ↳ Satinado Aluminio/Plástico
- ↳ Satinato Alluminio/Plastica

- ▶ Linkable LED light bar with transparent end caps for a visually uninterrupted strip light. The lights can be joined in series using an integrated connector. Each light can be controlled individually. Easy installation with mounting clips.
- ▶ Incl. power cable with standardised European plug
- ▶ Incl. connector for curves or transition areas
- ▶ Minimum dimensions
- ▶ Barras de luces LED concatenables con tapas en los extremos para crear una cinta de luz continua y sin interrupciones visibles. Las lámparas pueden acoplarse una detrás de otra mediante un conector integrado. Cada lámpara puede encenderse por separado. Sencilla instalación con clips de montaje.
- ▶ Incl. cable de alimentación con euroconector
- ▶ Incl. piezas de conexión para curvas o transiciones
- ▶ Dimensiones mínimas
- ▶ Listello LED concatenabile con cappucci terminali trasparenti per una striscia luminosa senza soluzione di continuità. Le luci possono essere combinate una dopo l'altra grazie a un connettore integrato. Ogni luce è comandabile singolarmente. Semplice installazione grazie alle clip di montaggio.
- ▶ Cavo di alimentazione incluso con spina europea
- ▶ Con cavo di collegamento per curve o punti di transizione
- ▶ Dimensioni minime



**Bond** A++-A

incl. 1x5 W  
370 lm, 4.000 K  
230 V  
⌀35 ⇄318 ↗25 mm  
EAN 4000870 706060  
**706.06**

**Bond** A++-A

incl. 1x8 W  
720 lm, 4.000 K  
230 V  
⌀35 ⇄518 ↗25 mm  
EAN 4000870 706121  
**706.12**

**Bond** A++-A

incl. 1x12 W  
950 lm, 4.000 K  
230 V  
⌀35 ⇄889 ↗25 mm  
EAN 4000870 706138  
**706.13**

**Bond** A++-A

incl. 1x15 W  
1.200 lm, 4.000 K  
230 V  
⌀35 ⇄1.146 ↗25 mm  
EAN 4000870 706145  
**706.14**



- 🔗 Matt aluminium 

Aluminium/Plastic
-------------------
- 🔗 Aluminium mate 

Aluminio/Plástico
-------------------
- 🔗 Alluminio opaco 

Alluminio/Plastica
--------------------



- ▶ LED under-cabinet lighting for the kitchen and more. 3 different variations of white light (warm white, neutral white, daylight white). Uniform illumination of work surfaces thanks to asymmetrical lighting
- ▶ High-quality aluminium housing
- ▶ Illuminated touch switch (blue)
- ▶ Easy installation using keyhole mounting

- ▶ Luminaria LED bajo armario para la iluminación de la cocina y otras aplicaciones. Selección de tres gradaciones del color blanco de la luz (blanco cálido, blanco neutro, blanco diurno). Iluminación uniforme de la superficie de trabajo mediante su salida de luz asimétrica
- ▶ Carcasa de aluminio de gran calidad
- ▶ Interruptor táctil iluminado (azul)
- ▶ Fácil montaje mediante fijación tipo ojo de cerradura

- ▶ Lampade sottopensile LED per l'illuminazione della cucina e molto altro ancora. Selezione di tre livelli di colore bianco (bianco caldo, bianco neutro, bianco luce diurna). Illuminazione omogenea della superficie di lavoro grazie a un'uscita asimmetrica della luce
- ▶ Custodia in alluminio di qualità
- ▶ Interruttore touch illuminato (blu)
- ▶ Montaggio semplice mediante tassello forato



**ChangeLine** A++-A

incl. 1x3,8 W  
280 lm, 2.700 - 6.500 K  
∠ 120°  
230/12 V, incl. ⚡ 8,4 VA  
⌀18 ⇄400 ↗40 mm  
EAN 4000870 705957  
**705.95**

LED  
tunable white  
Sensor  
incl.

**ChangeLine** A++-A

incl. 1x4,4 W  
330 lm, 2.700 - 6.500 K  
∠ 120°  
230/12 V, incl. ⚡ 8,4 VA  
⌀18 ⇄500 ↗40 mm  
EAN 4000870 705964  
**705.96**

LED  
tunable white  
Sensor  
incl.

**ChangeLine** A++-A

incl. 1x5 W  
380 lm, 2.700 - 6.500 K  
∠ 120°  
230/12 V, incl. ⚡ 8,4 VA  
⌀18 ⇄600 ↗40 mm  
EAN 4000870 705971  
**705.97**

LED  
tunable white  
Sensor  
incl.

**ChangeLine** A++-A

incl. 1x6,2 W  
480 lm, 2.700 - 6.500 K  
∠ 120°  
230/12 V, incl. ⚡ 8,4 VA  
⌀18 ⇄800 ↗40 mm  
EAN 4000870 705988  
**705.98**

LED  
tunable white  
Sensor  
incl.



🌀 White 📦 Plastic  
 🌀 Blanco 📦 Plástico  
 🌀 Bianco 📦 Plastica



- ▶ LED light bar in compact design
- ▶ Slim plastic profile
- ▶ Uniform light distribution
- ▶ Also for vertical mounting in shelf compartments sized for standard file folders
- ▶ Easily secured in place via screw holes
- ▶ Regleta de luces de LEDs en formato compacto
- ▶ Esbelto perfil de plástico
- ▶ Distribución lumínica uniforme
- ▶ También para montaje vertical en compartimentos con altura de archivador estándar
- ▶ Fácil fijación mediante molduras con rosca
- ▶ Listello luminoso LED a forma compatta
- ▶ Sottile profilo in plastica
- ▶ Distribuzione omogenea della luce
- ▶ Anche per il montaggio in verticale in vani d'armadio con altezza standard per classificatori
- ▶ Semplice fissaggio con canaline ad avvitamento

**CubeLine** A++-A

incl. 1x3,5W  
240 lm, 3.000 K  
∠ 120°

230/12 V, incl. ⚡ 3,6 VA

⤴24 ⤵300 ⤶19 mm

EAN 4000870 704004  
**704.00** 📦

**CubeLine** A++-A

incl. 1x5,5W  
350 lm, 3.000 K  
∠ 120°

230/12 V, incl. ⚡ 7 VA

⤴24 ⤵500 ⤶19 mm

EAN 4000870 704493  
**704.49** 📦

**CubeLine** A++-A

incl. 1x7W  
480 lm, 3.000 K  
∠ 120°

230/12 V, incl. ⚡ 7 VA

⤴24 ⤵600 ⤶19 mm

EAN 4000870 704509  
**704.50** 📦

**CubeLine** A++-A

incl. 1x9W  
650 lm, 3.000 K  
∠ 120°

230/12 V, incl. ⚡ 12 VA

⤴24 ⤵800 ⤶19 mm

EAN 4000870 704547  
**704.54** 📦

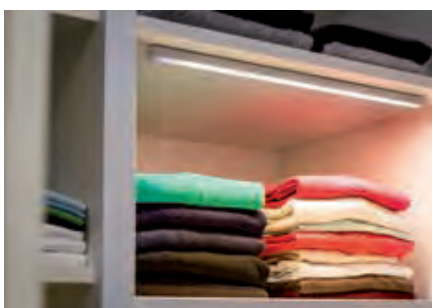

🌀 Matt aluminium 📦 Aluminium/Plastic  
 🌀 Aluminio mate 📦 Aluminio/Plástico  
 🌀 Alluminio opaco 📦 Alluminio/Plastica



- ▶ LED light bar with touch switch
- ▶ Incl. satined diffuser for uniform light distribution
- ▶ Convenient installation thanks to clip holder
- ▶ Ideal for 50 cm (70402) / 30 cm (70401) cabinet or shelf widths
- ▶ With blue illuminated touch switch for quick orientation in the dark
- ▶ Regleta de luces de LEDs con interruptor táctil
- ▶ Incl. difusor satinado para una distribución uniforme de la luz
- ▶ Cómodo montaje gracias a la fijación por presilla
- ▶ Ideal para anchuras de compartimento o armario de 50 cm (70402) / 30cm (70401)
- ▶ Con interruptor táctil de piloto azul para su rápida localización a oscuras
- ▶ Listello LED con interruttore touch
- ▶ Con diffusore satinato per la distribuzione omogenea della luce
- ▶ Comodo da montare grazie al supporto a clip
- ▶ Ideale per armadi o ripiani di 50 cm (70402) / 30 cm (70401) di larghezza
- ▶ Con interruttore touch luminoso blu per una più rapida individuazione al buio

**JetLine** A++-A

incl. 1x3,5W  
150 lm, 2.700 K  
∠ 120°

230/12 V, incl. ⚡ 3,6 VA

⤴17,5 ⤵260 ⤶20 mm

EAN 4000870 704011  
**704.01** 📦

**JetLine** A++-A

incl. 1x5,5W  
310 lm, 2.700 K  
∠ 120°

230/12 V, incl. ⚡ 7 VA

⤴17,5 ⤵460 ⤶20 mm

EAN 4000870 704028  
**704.02** 📦

**JetLine** A++-A

incl. 1x10W  
550 lm, 2.700 K  
∠ 120°

230/12 V, incl. ⚡ 12 VA

⤴17 ⤵560 ⤶14 mm

EAN 4000870 704455  
**704.45** 📦

**JetLine** A++-A

incl. 1x10,5W  
620 lm, 2.700 K  
∠ 120°

230/12 V, incl. ⚡ 12 VA

⤴14 ⤵660 ⤶17 mm

EAN 4000870 704462  
**704.46** 📦



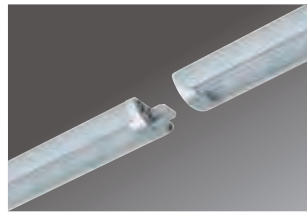
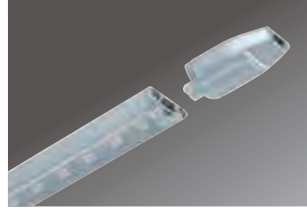

- ⌘ Aluminium/Satin
- ⌘ Aluminium/Acrylic
- ⌘ Aluminio/Satinado
- ⌘ Aluminio/Acrílico
- ⌘ Alluminio/Satinato
- ⌘ Alluminio/Acrílico

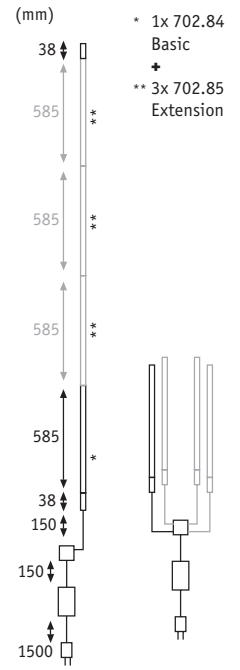

- ▶ Complete set for under-cabinet lighting with bright LED technology
- ▶ High-quality aluminium profiles with satinied cover
- ▶ Basic set can be augmented by 3 extensions (up to 4 bars in a system)
- ▶ Easy mounting thanks to clip attachments and plug-in system
- ▶ Juego completo para iluminación bajo armarios con la potente luminosidad de la tecnología LED
- ▶ Perfil de aluminio de gran calidad con revestimiento satinado
- ▶ El juego básico puede completarse con 3 ampliaciones (máx. 4 regletas en un sistema)
- ▶ Montaje sencillo por su sistema de encaje y soporte de clip
- ▶ Set completo per l'illuminazione di sottopensili con tecnologia LED ad alta intensità luminosa
- ▶ Profilato in alluminio di qualità con copertura satinata
- ▶ Set di base ampliabile con tre 3 prolunghe (massimo 4 listelli per sistema)
- ▶ Semplice montaggio grazie al supporto a clip e al sistema a innesto



**LinkLight Basic 24V** A++-A

incl. 1x7,5 W  
 380 lm, 3.000 K  
 <math>\angle 95^\circ</math>, 260 cd  
 230/24 V, incl.  $\square$  30 VA  
 $\updownarrow 10 \leftrightarrow 660 \varnothing 22$  mm  
 EAN 4000870 702840  
**702.84**

- LED
- incl.
- 
- 
- On/Off

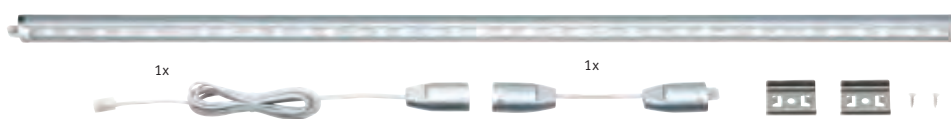

**LinkLight Extension 24V** A++-A

incl. 1x7,5 W  
 380 lm, 3.000 K  
 <math>\angle 95^\circ</math>, 260 cd  
 24 V  
 $\updownarrow 10 \leftrightarrow 625 \varnothing 22$  mm  
 EAN 4000870 702857  
**702.85**

- LED
- 
-



- 🔌 White 📦 Plastic
- 🔌 Blanco 📦 Plástico
- 🔌 Bianco 📦 Plastica

- 🔌 White 📦 Metal/Plastic
- 🔌 Blanco 📦 Metal/Plástico
- 🔌 Bianco 📦 Metallo/Plastica

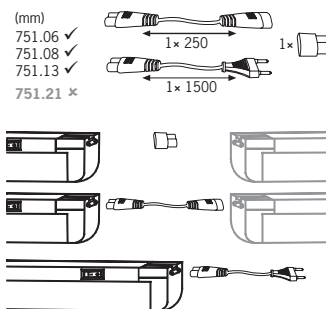

- ▶ Ready-to-plug-in energy-saving luminaire with electronic ballasts and integrated switch
- ▶ High energy efficiency
- ▶ Sliding block can be assembled flat or upright; no need to open the casing

- ▶ Lámpara de bajo consumo lista para enchufar con reactancia electrónica e interruptor integrado
- ▶ Alta eficacia energética
- ▶ Montaje plano o de canto sobre corredera; sin necesidad de abrir la carcasa

- ▶ Lampada a risparmio energetico pronta per il collegamento con alimentatore elettronico e interruttore integrato
- ▶ Elevata efficienza energetica
- ▶ Montaggio su pattino piatto o in verticale, senza necessità di aprire l'alloggiamento

**Slimline Micro**

incl. 1x6 W, G5, **A**  
320 lm, 3.000 K  
240 V

⌀43 ⇄269 ⇄28 mm  
EAN 4000870 751060

**751.06**

💡 885.06



A-A

**Slimline Micro**

incl. 1x8 W, G5, **A**  
480 lm, 3.000 K  
240 V

⌀43 ⇄345 ⇄28 mm  
EAN 4000870 751084

**751.08**

💡 885.08



A-A

**Slimline Micro**

incl. 1x13 W, G5, **A**  
950 lm, 3.000 K  
240 V

⌀43 ⇄574 ⇄28 mm  
EAN 4000870 751138

**751.13**

💡 885.13



A-A

**Slimline Micro**

incl. 1x21 W, G5, **A**  
1.890 lm, 4.000 K  
240 V

⌀43 ⇄905 ⇄28 mm  
EAN 4000870 751213

**751.21**

💡 885.62



A-A

- ▶ Slimline luminaire for 230 V direct connection
- ▶ With length prism for optimal light distribution and lamp protection
- ▶ With integrated switch
- ▶ With electronic ballasts
- ▶ Easy assembly using keyhole fastening

- ▶ Lámpara angosta para conexión directa a 230V
- ▶ Con prisma longitudinal para una óptima distribución lumínica y protección de la luminaria
- ▶ Con interruptor integrado
- ▶ Con reactancia electrónica
- ▶ Fácil montaje por fijación tipo ojo de cerradura

- ▶ Lampada slim per connessione diretta a 230 V
- ▶ Con prisma allungato per distribuzione ottimale della luce e protezione della lampadina
- ▶ Con interruttore integrato
- ▶ Con alimentatore elettronico
- ▶ Montaggio semplice mediante tassello forato

**Slimline**

incl. 1x15 W, G13, **A**  
963 lm, 2.700 K  
220-240 V

⌀36 ⇄494 ⇄64 mm  
EAN 4000870 750506

**750.50**

💡 885.15

A-B

**Slimline**

incl. 1x18 W, G13, **A**  
1.350 lm, 4.000 K  
220-240 V

⌀36 ⇄647 ⇄64 mm  
EAN 4000870 750803

**750.80**

💡 885.41

A-A

**Slimline**

incl. 1x30 W, G13, **A**  
2.400 lm, 4.000 K  
220-240 V

⌀36 ⇄950 ⇄64 mm  
EAN 4000870 750001

**750.00**

💡 885.20

A-A

**Slimline**

incl. 1x36 W, G13, **A**  
3.348 lm, 4.000 K  
220-240 V

⌀36 ⇄1.256 ⇄64 mm  
EAN 4000870 750605

**750.60**

💡 885.50

A-A

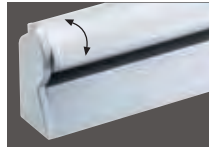

- 🌀 Matt aluminium 🏠 Metal/Plastic
- 🌀 Aluminio mate 🏠 Metal/Plástico
- 🌀 Alluminio opaco 🏠 Metallo/Plastica

- ▶ Swivelling under-cabinet lamp with integrated switch
- ▶ Swivels 120° for directed lighting in the closet interior
- ▶ High energy efficiency
- ▶ Easy-to-install keyhole fastening
- ▶ Incl. power cable with standardised European plug
- ▶ Luminaria orientable bajo armario con interruptor integrado
- ▶ Iluminación de interior de armario orientable en 120°
- ▶ Alta eficacia energética
- ▶ Fijación tipo cerradura para un fácil montaje
- ▶ Incl. cable de alimentación con euroconector
- ▶ Lampada sottopensile orientabile con interruttore integrato
- ▶ Illuminazione interna per armadi orientata con angolo d'inclinazione di 120°
- ▶ Elevata efficienza energetica
- ▶ Tassello forato per montaggio facile
- ▶ Cavo di alimentazione incluso con spina europea



**WaveLine** A-A

incl. 1x8 W, G5, 

480 lm, 3.000 K

230 V

⇅45 ⇄350 ↗85 mm

EAN 4000870 704059

**704.05** 

 885.08

 Energy Saver

 incl.





 0 sec.

 On/Off

**WaveLine** A-A

incl. 1x13 W, G5, 

980 lm, 3.000 K

230 V

⇅45 ⇄580 ↗85 mm

EAN 4000870 704066

**704.06** 

 885.13

 Energy Saver

 incl.





 0 sec.

 On/Off

# Outdoor

- 240 Floor
- 253 Accessories
- 255 Floor / Wall
- 257 Wall



263 Slot LED



248 MicroPen



255 Special Line AmbientLED



256 Special Line 360° Cube Flame



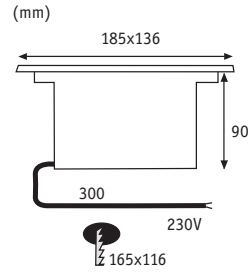

**Special Line Floor LED**

☒ Metal Metal Metallo

- ▶ Dust- and waterproof (IP67)
- ▶ Max. load up to 1,700 kg
- ▶ Operates directly with 230 V
- ▶ Hermético al polvo y protegido frente a inmersión en agua (IP67)
- ▶ Soporta hasta 1700 kg
- ▶ Funciona directamente con 230V
- ▶ Protezione da penetrazione di polvere e breve immersione in acqua (IP67)
- ▶ Carico fino a 1.700 kg
- ▶ Funzionamento diretto a 230 V

☞ Stainless steel Acero inoxidable Acciaio legato



**incl. 1x2,5 W** < A++-A  
 35 lm, 2.700 K  
 < 85°  
 230 V  
 EAN 4000870 937969  
**937.96**



**incl. 1x2,5 W** < A++-A  
 35 lm, 6.500 K  
 < 85°  
 230 V  
 EAN 4000870 937976  
**937.97**

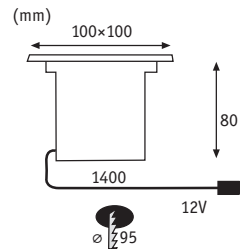

incl. Diffusor

**Special Line Floor LED**

☒ Metal Metal Metallo

- ▶ Included diffuser allows optional accentuated or diffused light
- ▶ El difusor adjunto permite acentuar o difuminar la luz
- ▶ Possibilità di scelta tra luce accentuata e diffusa grazie al diffusore in dotazione

☞ Stainless steel Acero inoxidable Acciaio legato



**incl. 3x1,2 W** < A++-A  
 3x35 lm, 2.700 K  
 < 120°, 17 cd  
 230/12 V,  
 incl. ⚡ 10,5 VA  
 EAN 4000870 937877  
**937.87**



**incl. 3x1,2 W** < A++-A  
 6.500 K  
 < 120°, 1,5 cd  
 230/12 V,  
 incl. ⚡ 10,5 VA  
 EAN 4000870 988763  
**988.76**



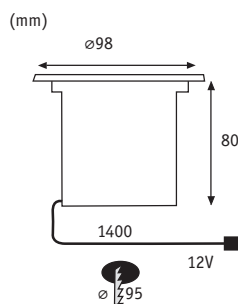
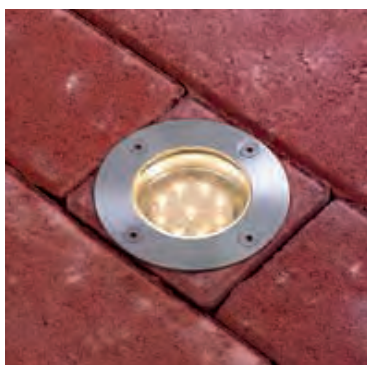

LED	
IP65	
Stainless Steel rost frei	
Kg	500

incl.  
Diffusor

**Special Line Floor LED**

☒ Metal Metal Metallo

- ▶ Included diffuser allows optional accentuated or diffused light
- ▶ El difusor adjunto permite acentuar o difuminar la luz
- ▶ Possibilità di scelta tra luce accentuata e diffusa grazie al diffusore in dotazione

☞ Stainless steel Acero inoxidable Acciaio legato



**incl. 3×1,2 W** <A++-A  
3×35 lm, 2.700 K  
∠ 120°, 17 cd  
230/12 V,  
incl. ⚡ 10,5 VA  
EAN 4000870 937891  
**937.89**



**incl. 3×1,2 W** <A++-A  
6.500 K  
∠ 120°, 1,5 cd  
230/12 V,  
incl. ⚡ 10,5 VA  
EAN 4000870 988770  
**988.77**

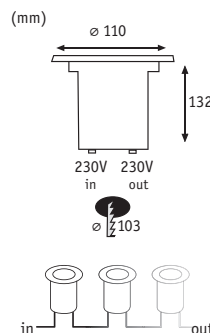
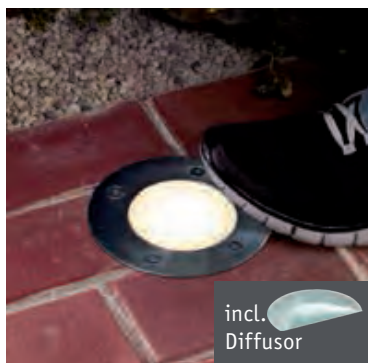

LED	IP67
Stainless Steel rost frei	
Kg	500

incl.  
Diffusor

**Special Line Floor LED**

☒ Metal Metal Metallo

- ▶ Included diffuser allows optional accentuated or diffused light
- ▶ Operates directly with 230 V
- ▶ El difusor adjunto permite acentuar o difuminar la luz
- ▶ Funciona directamente con 230 V
- ▶ Possibilità di scelta tra luce accentuata e diffusa grazie al diffusore in dotazione
- ▶ Funzionamento diretto a 230 V

☞ Stainless steel Acero inoxidable Acciaio legato



**incl. 1×1,2 W** <A++-A  
30 lm, 2.700 K  
∠ 120°, 17 cd  
230 V  
EAN 4000870 937884  
**937.88**



**incl. 1×1,2 W** <A++-A  
30 lm, 6.500 K  
∠ 120°, 1,5 cd  
230 V  
EAN 4000870 988756  
**988.75**

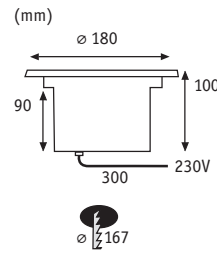

**Special Line Floor LED 2,1W**

Stainless steel Acero inoxidable Acciaio legato

- ▶ Dust- and waterproof (IP67)
- ▶ Integrated transformer allows for direct connection to the 230 V mains.
- ▶ Hermético al polvo y protegido frente a inmersión en agua (IP67)
- ▶ Mediante su equipo de alimentación integrado se puede conectar directamente a la instalación eléctrica (230V).
- ▶ Protezione da penetrazione di polvere e breve immersione in acqua (IP67)
- ▶ Collegabile direttamente al cablaggio domestico presente (230 V) mediante il dispositivo di alimentazione integrato.



Stainless steel Acero inoxidable Acciaio legato

**incl. 1x2,1 W** < A\*\* - A  
 60 lm, 6.500 K  
 230/12 V, incl.  $\text{---}$  3,6 VA  
 EAN 4000870 937464  
**937.46**

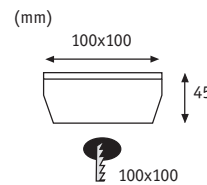

**Solar**

**Special Line Solar Cube/Box LED**

Stainless steel/Polycarbonate Acero inoxidable/Polycarbonato Acciaio legato/Polycarbonato

- ▶ 6-8 hour charge time with sun alignment, provides 8 to 10 hours of light
- ▶ Tiempo de carga en orientación al sol, 6-8 horas, duración luz, 8-10 horas
- ▶ Tempo di carica alla luce solare: 6-8 ore, durata di illuminazione: 8-10 ore



Stainless steel/Clear Acero inoxidable/Transparente Acciaio legato/Transparente

**incl. 1x0,24 W**  
 3,6 lm, 2.700 K  
 AA-Akku/1,5V (Mignon) × 1  
 EAN 4000870 937747  
**937.74**

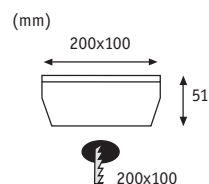

**Special Line Solar Cube/Box LED** Stainless steel/Polycarbonate Acero inoxidable/Polycarbonato Acciaio legato/Polycarbonato

- ▶ 6-8 hour charge time with sun alignment, provides 8 to 10 hours of light
- ▶ Tiempo de carga en orientación al sol, 6-8 horas, duración luz, 8-10 horas
- ▶ Tempo di carica alla luce solare: 6-8 ore, durata di illuminazione: 8-10 ore



Stainless steel/Clear Acero inoxidable/Transparente Acciaio legato/Trasparente

**incl. 1x0,6 W**  
7,5 lm, 2.700 K  
AA-Akku/1,5V (Mignon) × 2  
EAN 4000870 937754  
**937.75**

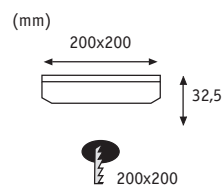
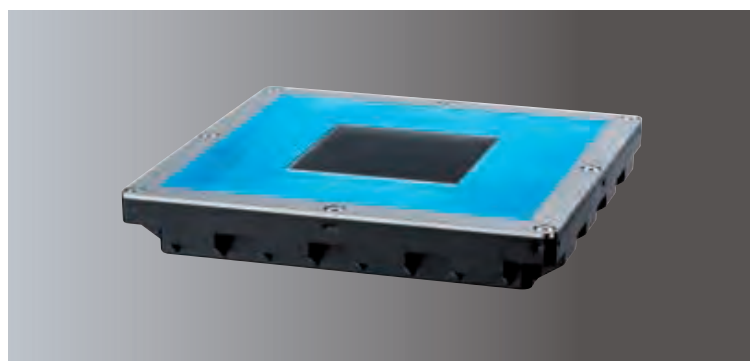

incl. colour diffuser



**Special Line Solar Cube LED Color** Stainless steel/Polycarbonate Acero inoxidable/Polycarbonato Acciaio legato/Polycarbonato

- ▶ 6-8 hour charge time with sun alignment, provides 8 to 10 hours of light
- ▶ Tiempo de carga en orientación al sol, 6-8 horas, duración luz, 8-10 horas
- ▶ Tempo di carica alla luce solare: 6-8 ore, durata di illuminazione: 8-10 ore



Stainless steel/RGB Acero inoxidable/RGB Acciaio legato/RGB

**incl. 1x0,6 W**  
7,5 lm, 2.700 K  
AA-Akku/1,5V (Mignon) × 2  
EAN 4000870 938348  
**938.34**

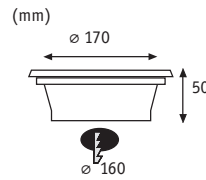
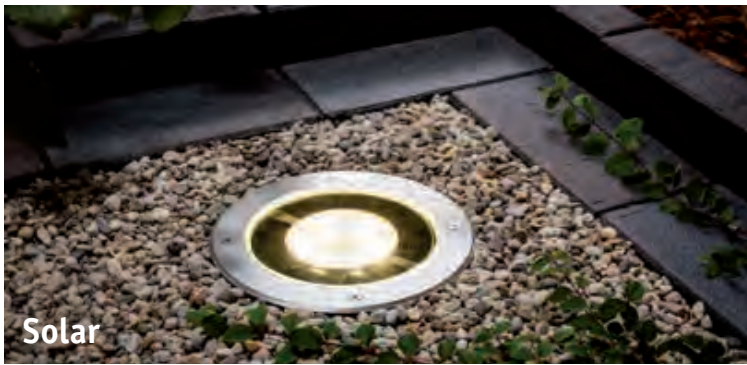

LED	☀️
IP67	⚡
Stainless Steel rost frei	
incl.	↓ Kg
Accu	1.000

**Special Line Solar Pandora LED**      Stainless steel/Glass   Acero inoxidable/Cristal   Acciaio legato/Vetro

- ▶ 6-8 hour charge time with sun alignment, provides 8 to 10 hours of light
- ▶ Tiempo de carga en orientación al sol, 6-8 horas, duración luz, 8-10 horas
- ▶ Tempo di carica alla luce solare: 6-8 ore, durata di illuminazione: 8-10 ore



Stainless steel/Clear   Acero inoxidable/Transparente   Acciaio legato/Trasparente

**incl. 1x0,36 W**  
9,8 lm, 2.700 K  
AA-Akku/1,5V (Mignon) × 2  
EAN 4000870 937761  
**937.76**

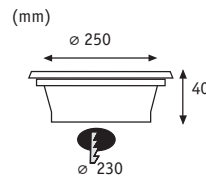

LED	☀️
IP67	⚡
Stainless Steel rost frei	
incl.	↓ Kg
Accu	1.000

**Special Line Solar Jupiter LED**      Stainless steel/Glass   Acero inoxidable/Cristal   Acciaio legato/Vetro

- ▶ 6-8 hour charge time with sun alignment, provides 8 to 10 hours of light
- ▶ Tiempo de carga en orientación al sol, 6-8 horas, duración luz, 8-10 horas
- ▶ Tempo di carica alla luce solare: 6-8 ore, durata di illuminazione: 8-10 ore



Stainless steel/Clear   Acero inoxidable/Transparente   Acciaio legato/Trasparente

**incl. 1x0,6 W**  
11 lm, 2.700 K  
AA-Akku/1,5V (Mignon) × 2  
EAN 4000870 937778  
**937.77**



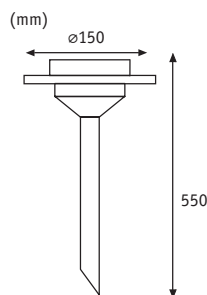
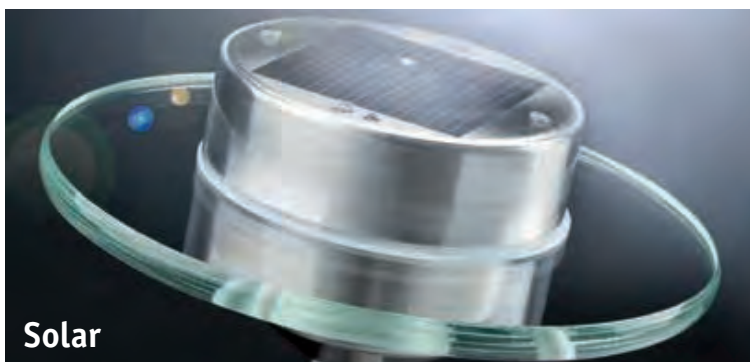

Solar

**Special Line Solar Ufo LED**

Stainless steel/Glass Acero inoxidable/Cristal Acciaio legato/Vetro

- ▶ 6-8 hour charge time with sun alignment, provides 3 to 5 hours of light
- ▶ Tiempo de carga en orientación al sol, 6-8 horas, duración luz, 3-5 horas
- ▶ Tempo di carica alla luce solare: 6-8 ore, durata di illuminazione: 3-5 ore



Stainless steel/Clear Acero inoxidable/Transparente Acciaio legato/Trasparente

**incl. 1x0,2W**

3.000 K  
 AAA-Akku/1,5V (Micro) x 2  
 EAN 4000870 937648  
**937.64**

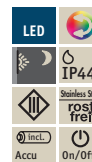
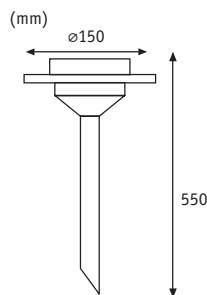

Solar

**Special Line Solar Ufo LED RGB**

Stainless steel/Glass Acero inoxidable/Cristal Acciaio legato/Vetro

- ▶ 6-8 hour charge time with sun alignment, provides 3 to 5 hours of light
- ▶ Tiempo de carga en orientación al sol, 6-8 horas, duración luz, 3-5 horas
- ▶ Tempo di carica alla luce solare: 6-8 ore, durata di illuminazione: 3-5 ore



Stainless steel/Clear Acero inoxidable/Transparente Acciaio legato/Trasparente

**incl. 1x0,2W**

AAA-Akku/1,5V (Micro) x 2  
 EAN 4000870 936993  
**936.99**





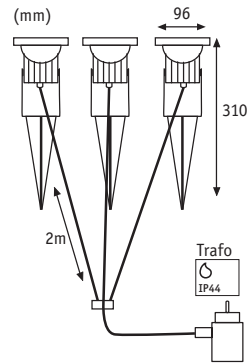

**Special Line Garden Spot LED**

Aluminium Aluminium Alluminio

Aluminium Aluminium Alluminio

**incl. 3x3 W** < A++-A

3.000 K  
 ∠ 45°, 275 cd  
 230/12 V, incl. 16 VA  
 EAN 4000870 988459  
**988.45**

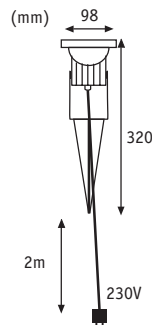

GU10  
 280.56  
 800.35

**Special Line Garden Spot**

Aluminium Aluminium Alluminio

Aluminium Aluminium Alluminio

**max. 28 W** < A++-E

230 V  
 EAN 4000870 937518  
**937.51**



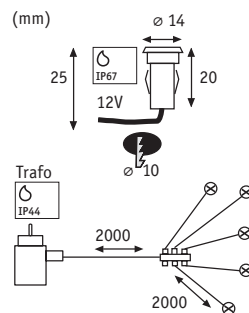

### Special Line Micro IP67 Basic

Polycarbonate Polycarbonato Policarbonato

- ▶ Basic set can be extended by the auxiliary set to up to 20 light points
- ▶ Easy mounting using plug-in connections
- ▶ El juego básico puede ampliarse con el juego complementario hasta a 20 puntos de luz
- ▶ Facilísimo de montar por conexión de enchufe
- ▶ Set di base ampliabile fino a 20 punti luce mediante set aggiuntivo
- ▶ Montaggio semplicissimo con connessione a innesto



Satin Satinado Satinato

incl. 5x0,16 W < A++-A

6.500 K  
230/12 V, incl. 6 VA  
EAN 4000870 988916  
**988.91**

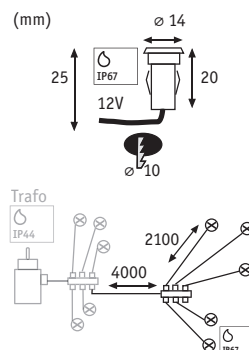

### Special Line Micro IP67 Extra

Polycarbonate Polycarbonato Policarbonato



Satin Satinado Satinato

incl. 5x0,16 W < A++-A

6.500 K  
DC 12 V  
EAN 4000870 988923  
**988.92**

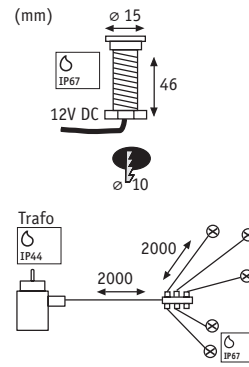

**Special Line MicroPen IP67 Basic**

Stainless steel Acero inoxidable Acciaio legato

- ▶ Basic set can be extended using the auxiliary set by up to 25 light points 4x 937.59
- ▶ Easy mounting using plug-in connections
- ▶ Installation in materials from 3 to 35 mm
- ▶ El juego básico puede ampliarse con el juego complementario hasta a 25 puntos de luz 4x 937.59
- ▶ Facilísimo de montar por conexión de enchufe
- ▶ Montaje en materiales de 3 a 35 mm
- ▶ Set di base ampliabile fino a 25 punti luce mediante set aggiuntivo 4x 937.59
- ▶ Montaggio semplicissimo con connessione a innesto
- ▶ Montaggio in materiali da 3 a 35mm



Stainless steel Acero inoxidable Acciaio legato

**incl. 5x0,16 W** <A++-A  
 3.000 K  
 30°, 1,4 cd  
 230/12 V, incl. 6 VA  
 EAN 4000870 937549  
**937.54**

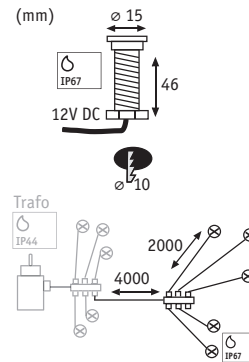

**Special Line MicroPen IP67 Extra**

Stainless steel Acero inoxidable Acciaio legato



Stainless steel Acero inoxidable Acciaio legato

**incl. 5x0,16 W** <A++-A  
 3.000 K  
 30°, 1,4 cd  
 DC 12 V  
 EAN 4000870 937594  
**937.59**

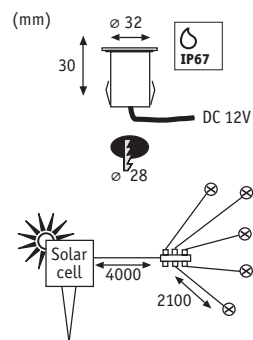

**Special Line Solarmodul Floor**    Stainless steel/Plastic   Acero inoxidable/Plástico   Acciaio legato/Plastica

- ▶ 6-8 hour charge time with sun alignment, provides 8 to 10 hours of light
- ▶ Tiempo de carga en orientación al sol, 6-8 horas, duración luz, 8-10 horas
- ▶ Tempo di carica alla luce solare: 6-8 ore, durata di illuminazione: 8-10 ore



Stainless steel/Black   Acero inoxidable/Negro   Acciaio legato/Nero

**incl. 5x0,2 W**  
 5x4 lm, 2.700 K  
 ∠ 120°  
 AA-Akku/1,5V (Mignon) x 3  
 DC 12 V  
 EAN 4000870 937679  
**937.67**



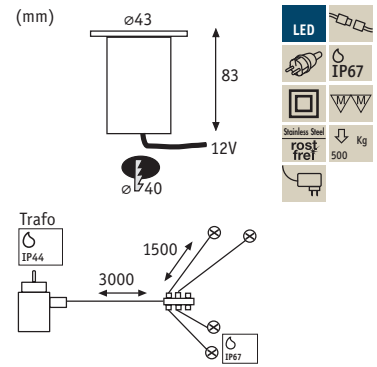
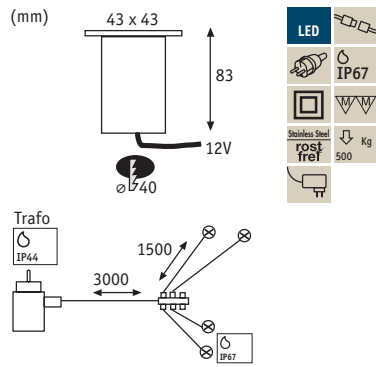

**Special Line MiniPlus Basic**

Stainless steel Acero inoxidable Acciaio legato

- ▶ Basic set can be extended by the auxiliary set to up to 12 light points
- ▶ Easy assembly using IP-protected screw connections
- ▶ El juego básico puede ampliarse con el juego complementario hasta a 12 puntos de luz
- ▶ Facilísimo de montar por conexiones de rosca con grado de protección IP
- ▶ Set di base ampliabile fino a 12 punti luce mediante set aggiuntivo
- ▶ Montaggio semplice mediante collegamenti a vite con protezione IP

Stainless steel Acero inoxidable Acciaio legato



**incl. 4x0,7 W** <A++-A  
 4x28 lm, 2.700 K  
 230/12 V, incl. ⚡ 16 VA  
 EAN 4000870 937860  
**937.86**



**incl. 4x0,7 W** <A++-A  
 4x28 lm, 2.700 K  
 230/12 V, incl. ⚡ 16 VA  
 EAN 4000870 937846  
**937.84**

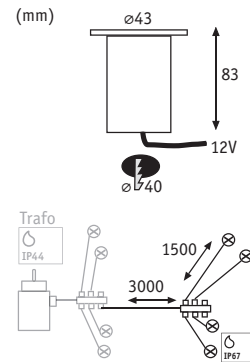
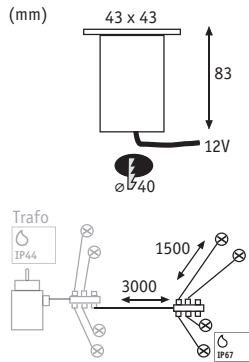

**Special Line MiniPlus Extra**

Stainless steel Acero inoxidable Acciaio legato

Stainless steel Acero inoxidable Acciaio legato



**incl. 4x0,7 W** <A++-A  
 4x28 lm, 2.700 K  
 12 V  
 EAN 4000870 937853  
**937.85**



**incl. 4x0,7 W** <A++-A  
 4x28 lm, 2.700 K  
 12 V  
 EAN 4000870 937839  
**937.83**



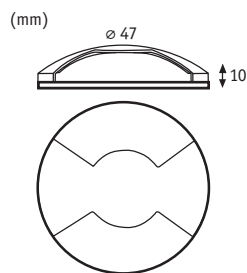

Stainless Steel  
rost  
fref  
Kg  
140



**Special Line MiniPlus Cover**

Stainless steel Acero inoxidable Acciaio legato

- ▶ Decorative glare protection for the MiniPlus Floor recessed light
- ▶ Decorativo antideslumbrante para la lámpara empotrable de suelo MiniPlus
- ▶ Protezione antiabbagliante decorativa per il faretto a incasso da pavimento MiniPlus



Stainless steel Acero inoxidable Acciaio legato

EAN 4000870 937723  
**937.72**

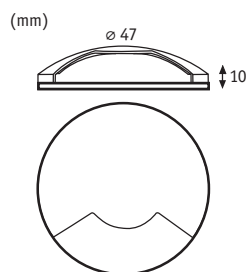

Stainless Steel  
rost  
fref  
Kg  
140



**Special Line MiniPlus Cover**

Stainless steel Acero inoxidable Acciaio legato

- ▶ Decorative glare protection for the MiniPlus Floor recessed light
- ▶ Decorativo antideslumbrante para la lámpara empotrable de suelo MiniPlus
- ▶ Protezione antiabbagliante decorativa per il faretto a incasso da pavimento MiniPlus



Stainless steel Acero inoxidable Acciaio legato

EAN 4000870 937907  
**937.90**

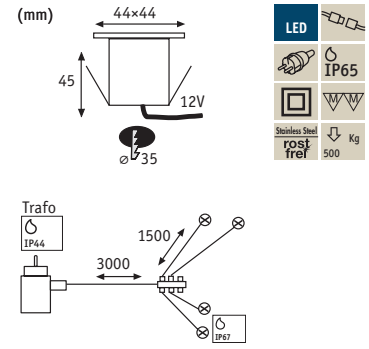
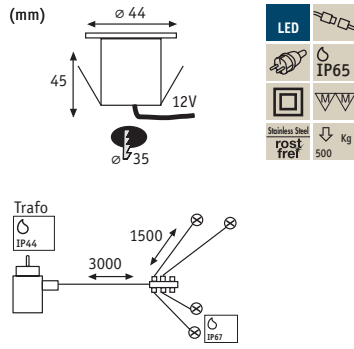

**Special Line Mini Basic**

Stainless steel Acero inoxidable Acciaio legato

- ▶ Basic set can be extended by the auxiliary set to up to 12 light points
- ▶ Easy assembly using IP-protected screw connections
- ▶ El juego básico puede ampliarse con el juego complementario hasta a 12 puntos de luz
- ▶ Facilísimo de montar por conexiones de rosca con grado de protección IP
- ▶ Set di base ampliabile fino a 12 punti luce mediante set aggiuntivo
- ▶ Montaggio semplice mediante collegamenti a vite con protezione IP

Stainless steel Acero inoxidable Acciaio legato



**incl. 4x0,6 W** <A++-A  
7.000 K  
230/12 V, incl. 6 VA  
EAN 4000870 988688  
**988.68**



**incl. 4x0,6 W** <A++-A  
7.000 K  
230/12 V, incl. 6 VA  
EAN 4000870 988701  
**988.70**

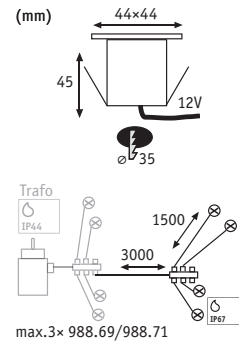
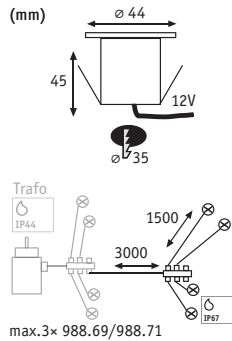

LED  
IP65  
Stainless Steel  
rost frei  
Kg  
500

**Special Line Mini Extra**

Stainless steel Acero inoxidable Acciaio legato



**incl. 4x0,6 W** <A++-A  
7.000 K  
12 V  
EAN 4000870 988695  
**988.69**



**incl. 4x0,6 W** <A++-A  
7.000 K  
12 V  
EAN 4000870 988718  
**988.71**



**Special Line IP65 Connector**

☒ Rubber Goma Gomma

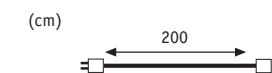

**max. 100 W**

12 V  
EAN 4000870 938232  
**938.23** 📦



**max. 100 W**

12 V  
EAN 4000870 988466  
**988.46** 📦



**max. 100 W**

12 V  
EAN 4000870 938249  
**938.24** 📦



**Special Line IP65 Connector**

☒ Plastic Plástico Plastica

🖤 Black Negro Nero



**max. 100 W**

12 V  
EAN 4000870 938331  
**938.33** 📦



**Special Line Junction-Box**

Plastic Plástico Plastica

- ▶ Connection box for up to 4 lines
- ▶ Unused outputs remain closed
- ▶ Dust- and waterproof (IP67)
- ▶ Caja de conexión para 4 cables
- ▶ Las tomas que no se usan permanecen cerradas
- ▶ Hermético al polvo y protegido frente a inmersión en agua (IP67)
- ▶ Scatola di collegamento fino a 4 linee
- ▶ Le uscite inutilizzate rimangono chiuse
- ▶ Protezione da penetrazione di polvere e breve immersione in acqua (IP67)



Black Negro Nero

**max. 2.500 W**

EAN 4000870 002322

**232**

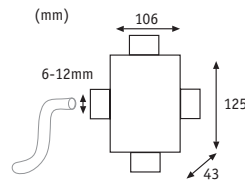

IP67

**Special Line Junction-Box**

Plastic Plástico Plastica



Black Negro Nero

**max. 2.500 W**

EAN 4000870 002377

**237 new**

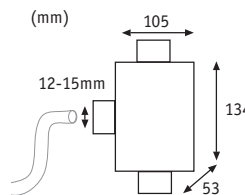

IP68

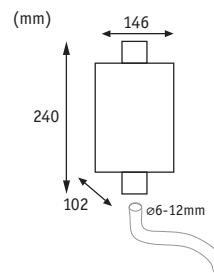

IP65



**Outdoorbox IP65**

Aluminium Aluminio Alluminio



↑102 ↔146 ↗240 mm

EAN 4000870 988473

**988.47**

- Black Aluminium
- Negro Aluminio
- Nero Alluminio





**Special Line AmbientLED**

Aluminium zinc / Aluminio cinc / Alluminio zincato

- ▶ Operates directly with 230 V
- ▶ Can be expanded with decorative glass elements
- ▶ Funciona directamente con 230 V
- ▶ Ampliables con decorativos cristales
- ▶ Funzionamento diretto a 230 V
- ▶ Possibilità di ampliamento con vetri decorativi



Matt white / Blanco mate / Bianco opaco



**incl. 1x2,4 W** <math>A^{++}-A</math>  
 110 lm, 2.700 K  
 <math>\sphericalangle 30^\circ</math>  
 230 V, incl. <math>-3,6 VA</math>  
 EAN 4000870 938119  
**938.11**

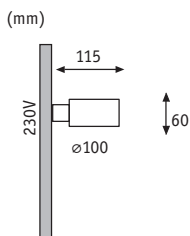

**AmbientLED Dekor**

<math>\updownarrow 130 \varnothing 98 \text{ mm}</math>  
 EAN 4000870 938126

**938.12**  
 Matt white / Blanco mate / Bianco opaco  
 Satin / Acrylic / Acrílico / Acrílico

rost/frei

Matt white / Blanco mate / Bianco opaco



**incl. 1x2,4 W** <math>A^{++}-A</math>  
 110 lm, 2.700 K  
 <math>\sphericalangle 30^\circ</math>  
 230 V, incl. <math>-3,6 VA</math>  
 EAN 4000870 938157  
**938.15**

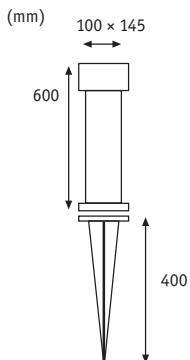

**AmbientLED Dekor**

<math>\updownarrow 130 \varnothing 98 \leftrightarrow 98 \nearrow 60 \text{ mm}</math>  
 EAN 4000870 938133

**938.13**  
 Matt white / Blanco mate / Bianco opaco  
 Gold / Oro / Aluminium / Alluminio

rost/frei

**AmbientLED Dekor**

<math>\updownarrow 130 \varnothing 98 \text{ mm}</math>  
 EAN 4000870 938140

**938.14**  
 Brushed aluminium / Alluminio  
 Aluminium / Alluminio  
 Aluminium mateado / Alluminio  
 Alluminio spazzolato / Alluminio

rost/frei





**Special Line 360° Cube Flame**

Aluminium zinc Aluminio cinc Alluminio zincato

► Operates directly with 230 V

► Funciona directamente con 230 V

► Funzionamento diretto a 230 V

Matt white Blanco mate Bianco opaco

**incl. 1x7 W** <math>A^{++}-A</math>

480 lm, 2.700 K

$\sphericalangle$  30°

230 V, incl.  $\text{⚡}$  9 VA

EAN 4000870 938164

**938.16**

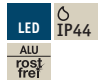
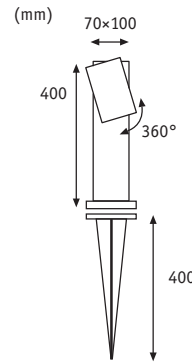

**Special Line 360° Cube Flame**

Aluminium Aluminio Alluminio

► Operates directly with 230 V

► Funciona directamente con 230 V

► Funzionamento diretto a 230 V

Matt white Blanco mate Bianco opaco

**incl. 1x7 W** <math>A^{++}-A</math>

240 lm, 2.700 K

$\sphericalangle$  32°

230 V, incl.  $\text{⚡}$  8,3 VA

EAN 4000870 937822

**937.82**

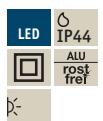
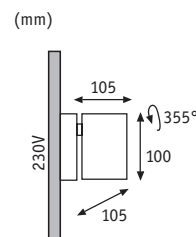

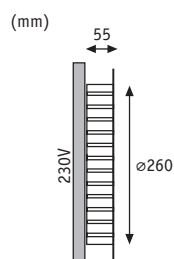

**Special Line House Number Sunset** Stainless steel/Polycarbonate Acero inoxidable/Polycarbonato Acciaio legato/Polycarbonato

- |  |   |  |
|--|---|--|
| ▶ Operates directly with 230 V                             | ▶ Funciona directamente con 230 V                         | ▶ Funzionamento diretto a 230 V  |
| ▶ With twilight switch                                     | ▶ Con interruptor crepuscular                             | ▶ Con interruttore crepuscolare  |
| ▶ Incl. house numbers in stainless steel effect            | ▶ Incl. números de edificio en óptica de acero            | ▶ Con numero civico effetto acciaio inox                                 |
| ▶ House number size 10cm, in line with official guidelines | ▶ Tamaño de número 10cm, corresponde con la norma oficial | ▶ Dimensioni del numero civico: 10 cm, secondo le disposizioni ufficiali |



Stainless steel/White Acero inoxidable/Blanco Acciaio legato/Bianco

**incl. 1x5,6 W** A++-A  
160 lm, 2.700 K  
230 V  
EAN 4000870 937914  
**937.91**

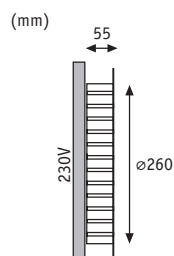

**Special Line House Number Sun** Stainless steel/Polycarbonate Acero inoxidable/Polycarbonato Acciaio legato/Polycarbonato

- |                                |                                   |                                 |
|--------------------------------|-----------------------------------|---------------------------------|
| ▶ Operates directly with 230 V | ▶ Funciona directamente con 230 V | ▶ Funzionamento diretto a 230 V |
|--------------------------------|-----------------------------------|---------------------------------|



Stainless steel/White Acero inoxidable/Blanco Acciaio legato/Bianco

**incl. 1x5,6 W** A++-A  
160 lm, 2.700 K  
230 V  
EAN 4000870 937693  
**937.69**

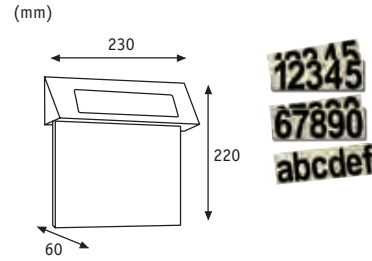

**Special Line Solar House Number**    Stainless steel/Acrylic    Acero inoxidable/Acrílico    Acciaio legato/Acriclico

- ▶ 6-8 hour charge time with sun alignment, provides 4 to 6 hours of light
- ▶ Tiempo de carga en orientación al sol, 6-8 horas, duración luz, 4-6 horas
- ▶ Tempo di carica alla luce solare: 6-8 ore, durata di illuminazione: 4-6 ore



Stainless steel/White    Acero inoxidable/Blanco    Acciaio legato/Bianco

**incl. 1x0,2W**  
 3.000 K  
 AA-Akku/1,5V (Mignon) x 2  
 EAN 4000870 937655  
**937.65**

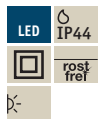
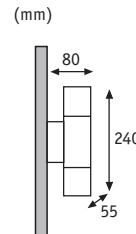

**Special Line 2Flame**    Aluminium zinc    Aluminio cinc    Alluminio zincato

- ▶ Operates directly with 230 V
- ▶ Funciona directamente con 230 V
- ▶ Funzionamento diretto a 230 V



Black/Brushed aluminium    Negro/Aluminio mateado    Nero/Alluminio spazzolato

**incl. 2x3,2W**    A++-A  
 360 + 360 lm, 2.700 K  
 ∠ 45°, 460 cd  
 230 V  
 EAN 4000870 180044  
**180.04 new**

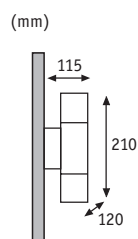

### Special Line 2Flame

Aluminium zinc Aluminium cinc Alluminio zincato

► Operates directly with 230 V

► Funciona directamente con 230 V

► Funzionamento diretto a 230 V



Black/Brushed aluminium Negro/Aluminio mateado Nero/Alluminio spazzolato

**incl. 2x3,2 W** < A++-A

360 + 360 lm, 2.700 K

∠ 45°, 460 cd

230 V

EAN 4000870 180051

**180.05 new**

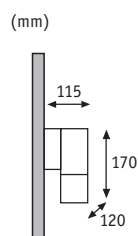

### Special Line 1Flame

Aluminium zinc Aluminium cinc Alluminio zincato

► Operates directly with 230 V

► Funciona directamente con 230 V

► Funzionamento diretto a 230 V



Black/Brushed aluminium Negro/Aluminio mateado Nero/Alluminio spazzolato

**incl. 1x3,2 W** < A++-A

360 lm, 2.700 K

∠ 45°, 460 cd

230 V

EAN 4000870 180068

**180.06 new**



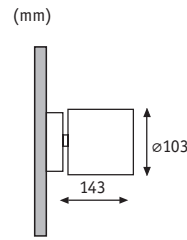

**Special Line Big Flame**

Aluminium Aluminium Alluminio

► Operates directly with 230 V

► Funciona directamente con 230 V

► Funzionamento diretto a 230 V



Matt white Blanco mate Bianco opaco

incl. 1×5 W < A<sup>++</sup>-A

436 lm, 2.700 K

∠ 60°

230 V

EAN 4000870 180075

**180.07 new**

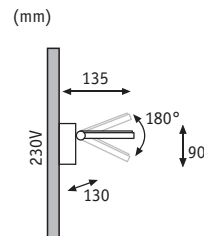

**Special Line Board**

Aluminium Aluminium Alluminio

► Operates directly with 230 V

► Funciona directamente con 230 V

► Funzionamento diretto a 230 V



Matt white Blanco mate Bianco opaco

incl. 1×7,2 W < A<sup>++</sup>-A

420 lm, 2.700 K

∠ 100°

230 V, incl. 6 VA

EAN 4000870 937815

**937.81**



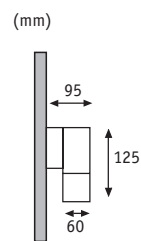

GU10  
⚡ 282.99



### Special Line Flame

Aluminium Aluminium Alluminio

► Operates directly with 230 V

► Funciona directamente con 230 V

► Funzionamento diretto a 230 V



Brushed iron Hierro mateado Ferro spazzolato

incl. 1×3,5 W, A++ < A++-E

230 lm, 2.700 K

230 V

EAN 4000870 180082

**180.08 new**

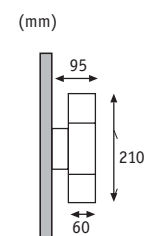

GU10  
⚡ 282.99



### Special Line Flame

Aluminium Aluminium Alluminio

► Operates directly with 230 V

► Funciona directamente con 230 V

► Funzionamento diretto a 230 V



Brushed iron Hierro mateado Ferro spazzolato

incl. 2×3,5 W, A++ < A++-E

2×230 lm, 2.700 K

230 V

EAN 4000870 180099

**180.09 new**

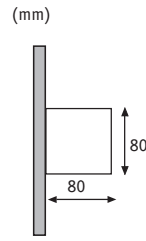

∠ 40-120°



**Special Line Cybo**

Aluminium Aluminium Alluminio

- ▶ Beam angle 40–120° with folding mechanism for infinite setting options
- ▶ Ángulo de irradiación 40-120° regulable mediante un mecanismo abatible
- ▶ Angolo di irradiazione regolabile in modo variabile 40-120° grazie al meccanismo di chiusura

Grey Gris Grigio



**incl. 2×3 W** <A++-A  
355 + 355 lm, 2.700 K  
∠ 40°-120°  
230 V  
EAN 4000870 180006  
**180.00 new**

White Blanco Bianco



**incl. 2×3 W** <A++-A  
355 + 355 lm, 2.700 K  
∠ 40°-120°  
230 V  
EAN 4000870 180013  
**180.01 new**

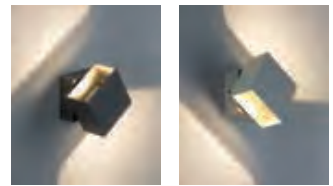
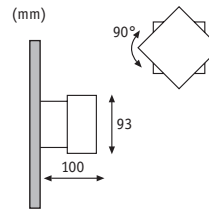

**Special Line Cybo**

Aluminium Aluminium Alluminio

Grey Gris Grigio

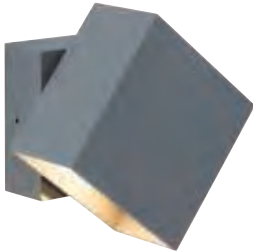

**incl. 2×3 W** <A++-A  
355 + 355 lm, 2.700 K  
∠ 85°  
230 V  
EAN 4000870 180020  
**180.02 new**

White Blanco Bianco



**incl. 2×3 W** <A++-A  
355 + 355 lm, 2.700 K  
∠ 85°  
230 V  
EAN 4000870 180037  
**180.03 new**

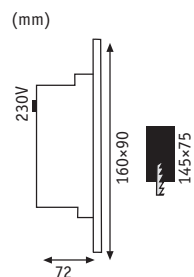

**Special Line Slot LED** Aluminium Aluminium Alluminio

- ▶ Operates directly with 230 V
- ▶ Incl. recessed socket
- ▶ Funciona directamente con 230 V
- ▶ Caja de enchufe incluida
- ▶ Funzionamento diretto a 230 V
- ▶ Incl. scatola da incasso

Matt aluminium Aluminium mate Alluminio opaco



**incl. 1x2,4 W** <A++-A  
120 lm, 2.700 K  
∠ 30°  
230 V  
EAN 4000870 938263  
**938.26**

Matt white Blanco mate Bianco opaco



**incl. 1x2,4 W** <A++-A  
120 lm, 2.700 K  
∠ 30°  
230 V  
EAN 4000870 938089  
**938.08**

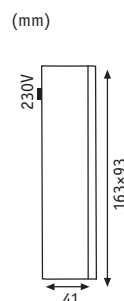

**Special Line Slot LED** Aluminium Aluminium Alluminio

- ▶ Operates directly with 230 V
- ▶ Funciona directamente con 230 V
- ▶ Funzionamento diretto a 230 V

Matt aluminium Aluminium mate Alluminio opaco



**incl. 1x2,4 W** <A++-A  
120 lm, 2.700 K  
∠ 30°  
230 V  
EAN 4000870 938256  
**938.25**

Matt white Blanco mate Bianco opaco



**incl. 1x2,4 W** <A++-A  
120 lm, 2.700 K  
∠ 30°  
230 V  
EAN 4000870 938096  
**938.09**

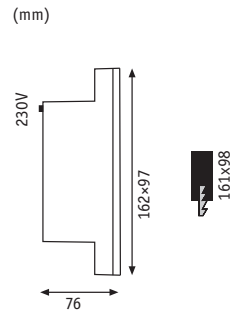

**Special Line Wall LED**

Aluminium Aluminium Alluminio

- ▶ Operates directly with 230 V
- ▶ Funciona directamente con 230 V
- ▶ Funzionamento diretto a 230 V
- ▶ Incl. recessed socket
- ▶ Caja de enchufe incluida
- ▶ Incl. scatola da incasso



Titanium Titanio Titano

**incl. 1x2,4 W** <A++-A

6 lm, 6.500 K

230 V

EAN 4000870 998182

**998.18**

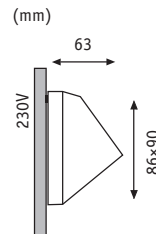

**Special Line Wall LED**

Aluminium Aluminium Alluminio

- ▶ Operates directly with 230 V
- ▶ Funciona directamente con 230 V
- ▶ Funzionamento diretto a 230 V

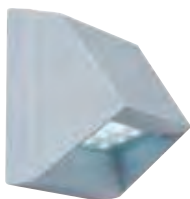

Titanium Titanio Titano

**incl. 1x1,5 W** <A++-A

29 lm, 6.500 K

230 V

EAN 4000870 998175

**998.17**

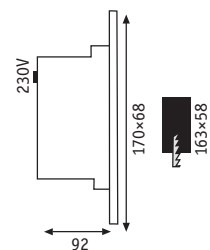

(mm)

**Special Line Wall LED**

☒ Stainless steel Acero inoxidable Acciaio legato

► Operates directly with 230 V

► Funciona directamente con 230 V

► Funzionamento diretto a 230 V



☒ Stainless steel Acero inoxidable Acciaio legato

**incl. 1x1,2 W** < A++-A

27 lm, 6.500 K

230 V

EAN 4000870 998168

**998.16**





## Downlights

- 268 Wall
- 276 Floor
- 280 Ceiling
- 354 CabinetLight
- 376 2Easy
- 381 Accessories



335 Star Rolling



310 Premium Drip



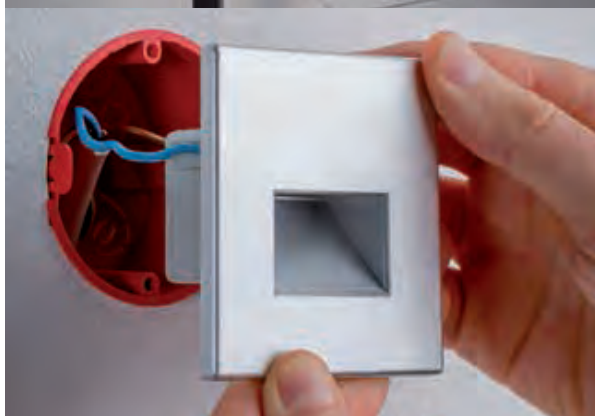

## Wall | Downlights

Recessed wall luminaires for modern lighting accents can be used as orientation lights in corridors and staircases, kitchens and bathrooms.

Luminarias empotrables en la pared para toques luminosos modernos que sirven como luces de orientación en pasillos y escaleras, cocinas y baños.

Faretti da incasso a parete per un tocco di modernità, che si possono impiegare anche come luci di orientamento in corridoi o scale, cucine e bagni.



- ▶ Very easy installation with a self-adhesive flat ribbon cable
- ▶ Incluye 1.2 m power cable with switch and plug
- ▶ Direct transformer power connection possible
- ▶ Montaje facilísimo gracias al cable plano autoadhesivo
- ▶ Incl. cable de alimentación de 1,2 m con enchufe e interruptor
- ▶ Es posible la alimentación directa del transformador
- ▶ Montaggio semplicissimo con cavo a nastro autoadesivo
- ▶ Cavo di alimentazione da 1,2 m, interruttore e connettore inclusi
- ▶ Possibilità di alimentazione diretta con trasformatore

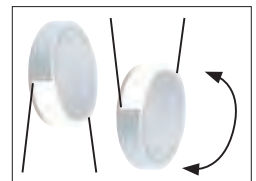
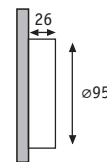
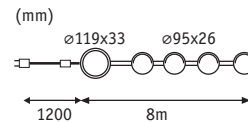

**Special Line StairLED**

Aluminium/Polycarbonate Aluminio/Polycarbonato Alluminio/Polycarbonato

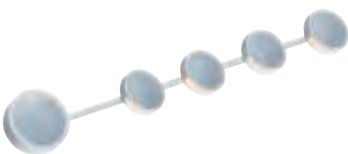

White/Aluminium structure Blanco/Estructura de aluminio Bianco/Alu structure

**incl. 4x1,6 W** A++-A  
 4x25 lm, 2.700 K  
 230V, incl. 10 VA  
 EAN 4000870 938072  
**938.07**

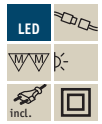
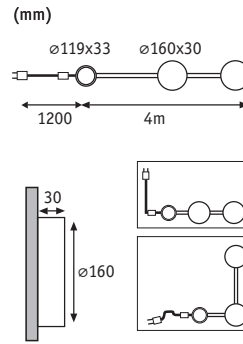

**Special Line Wall LED Corona**

Die cast aluminium Aluminio inyectado a presión Alluminio pressofuso

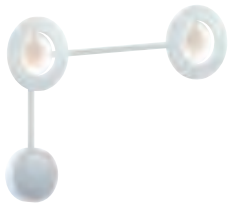

Matt white Blanco mate Bianco opaco

**incl. 2x4,5 W** A++-A  
 2x520 lm, 2.700 K  
 230V, incl.  $\text{⚡}$  10 VA  
 EAN 4000870 938218  
**938.21**

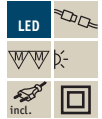
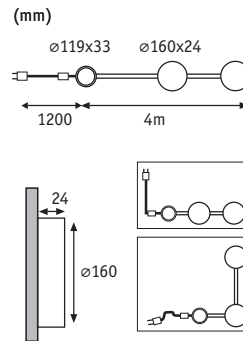

**Special Line Wall LED Flow**

Plastic Plástico Plastica

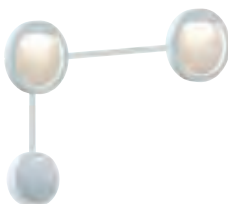

Matt white Blanco mate Bianco opaco

**incl. 2x2,3 W** A++-A  
 2x260 lm, 2.700 K  
 230V, incl.  $\text{⚡}$  10 VA  
 EAN 4000870 938225  
**938.22**



Combine your own personal lighting system  
 Combine usted mismo su sistema de luz personal  
 Scegliete voi stessi le combinazioni per il vostro sistema d'illuminazione personalizzato

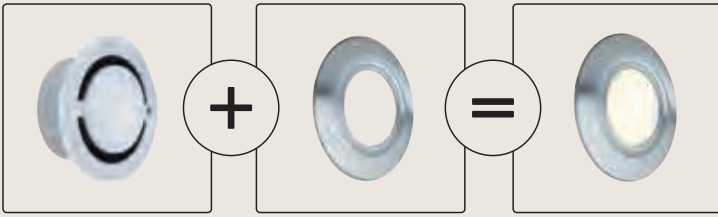

**Special Line IP65 Downlight Basic**

Polycarbonate Policarbonato Policarbonato

- ▶ Toolless mounting of stainless-steel decor by Velcro strip
- ▶ Assembly possible directly in 60 mm recessed sockets
- ▶ Se complementa con embellecedor de acero de ley
- ▶ Es posible montarlo directamente en cajas de enchufe de 60 mm
- ▶ Rifinito con copertura in acciaio inox
- ▶ Possibilità di montaggio diretto in scatole da incasso da 60 mm



Opal Opal Opale

**incl. 1x1,4 W** <math>A^{++}-A</math>  
 3.000 K  
 230 V  
 EAN 4000870 937402  
**937.40**



Opal Opal Opale

**incl. 1x1,4 W** <math>A^{++}-A</math>  
 4.000 K  
 230 V  
 EAN 4000870 937419  
**937.41**

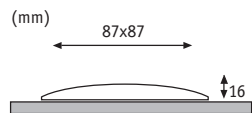
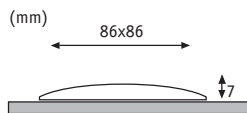
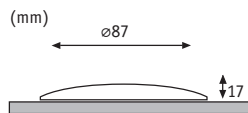
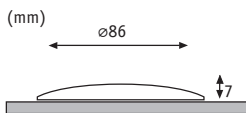
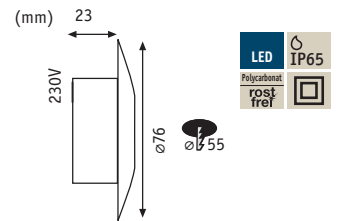

**Special Line Cover round**

**7**  $\varnothing$ 86 mm  
 EAN 4000870 937426  
**937.42**



**Special Line Cover Cap round**

**17**  $\varnothing$ 87 mm  
 EAN 4000870 937433  
**937.43**



**Special Line Cover square**

**7**  $\varnothing$ 86  $\varnothing$ 86 mm  
 EAN 4000870 937440  
**937.44**



**Special Line Cover Cap square**

**16**  $\varnothing$ 87  $\varnothing$ 87 mm  
 EAN 4000870 937457  
**937.45**





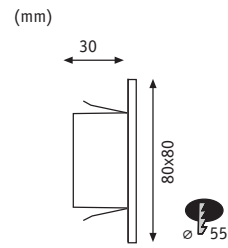
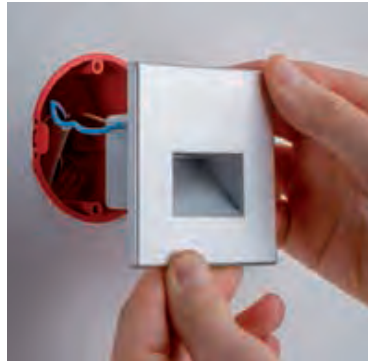

### Special Line Wall LED Edge

Plastic Plástico Plastica



Chrome matt Cromo mate Cromo opaco

incl. 1x1,1 W < A++-A

116 lm, 2.700 K

∠ 100°

230 V

EAN 4000870 994955

994.95 € **new**

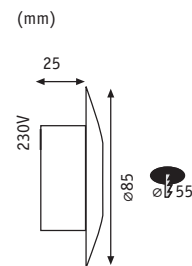

### Special Line IP65 Downlight

Metal/Plastic Metal/Plástico Metallo/Plastica

- ▶ Assembly possible directly in 60 mm recessed sockets
- ▶ Operates directly with 230 V
- ▶ Es posible montarlo directamente en cajas de enchufe de 60 mm
- ▶ Funciona directamente con 230 V
- ▶ Possibilità di montaggio diretto in scatole da incasso da 60 mm
- ▶ Funzionamento diretto a 230 V



Satin nickel/Opal Níquel satinado/Opal Nichel satinato/Opale

incl. 1x0,25 W < A++-A

8,6 lm, 5.000 K

∠ 120°

230 V

EAN 4000870 989883

989.88 €

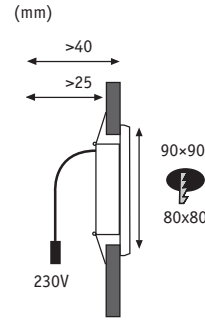

**Premium Line Areal**

Aluminium Aluminium Alluminio

- ▶ Multichip LED for optimal light distribution
- ▶ Operates directly with 230 V
- ▶ LED Multichip para una distribución óptima de la luz
- ▶ Funciona directamente con 230 V
- ▶ LED multichip per la distribuzione ottimale della luce
- ▶ Funzionamento diretto a 230 V



Chrome matt Cromo mate Cromo opaco

**incl. 3x2 W** <math>A^{++}-A</math>  
 3x70 lm, 3.000 K  
 230 V  
 EAN 4000870 937587  
**937.58**

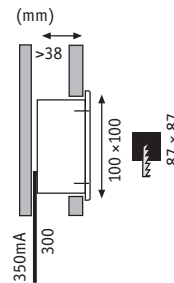

**Special Line Wall LED Quadro**

Aluminium Aluminium Alluminio

- ▶ Is delivered incl. installation frame
- ▶ Se suministra con bastidor empotrable incluido
- ▶ Fornito con cornice da incasso inclusa



Brushed aluminium Aluminium mateado Alluminio spazzolato

**incl. 1x2 W** <math>A^{++}-A</math>  
 50 lm, 3.000 K  
 230 V, incl. 3 VA  
 EAN 4000870 937532  
**937.53**

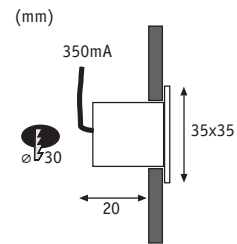

Micro Line Mini LED

Aluminium Aluminium Alluminio



Chrome Cromo Cromo

incl. 5x1 W &lt;math&gt;A^{++}&lt;/math&gt;-A

5x60 lm, 2.700 K  
 $\sphericalangle$  75°, 45 cd  
 230 V, incl.  $\text{⚡}$  6 VA  
 EAN 4000870 935507  
**935.50**

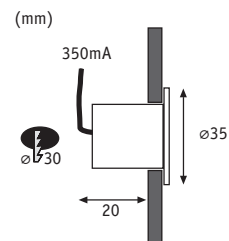

Micro Line Mini LED

Aluminium Aluminium Alluminio



Chrome Cromo Cromo

incl. 5x1 W &lt;math&gt;A^{++}&lt;/math&gt;-A

5x60 lm, 2.700 K  
 $\sphericalangle$  75°, 45 cd  
 230 V, incl.  $\text{⚡}$  6 VA  
 EAN 4000870 935514  
**935.51**

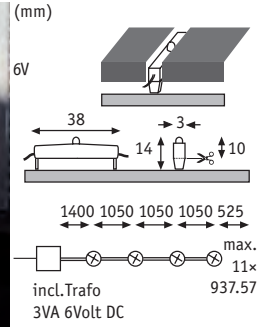
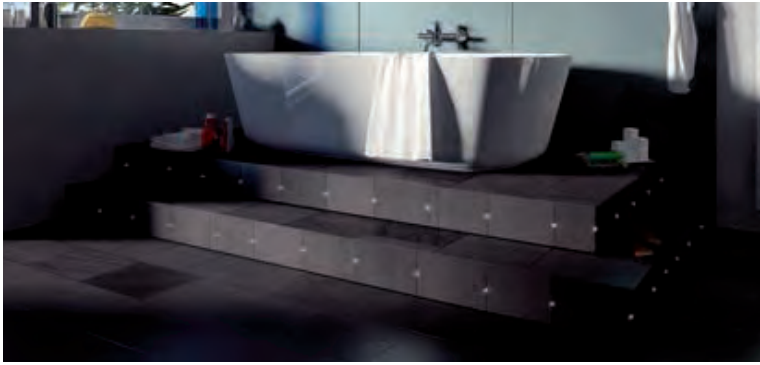

**Special Line GrooveLight Basic** Plastic Plástico Plastica

- ▶ The product dimensions are ideal for current tile sizes
- ▶ The light can also be inserted vertically or horizontally in tile joints and in seams as narrow as 3 mm (cables can be laid diagonally).
- ▶ The basic set is expandable to a total of 48 LED elements or 11 x 93757
- ▶ Las dimensiones del producto se adecúan perfectamente a las medidas actuales de baldosas
- ▶ La lámpara puede colocarse vertical u horizontalmente en intersecciones de baldosas o también en ranuras de tan solo 3mm (los cables pueden tenderse diagonalmente).
- ▶ El juego básico es ampliable hasta un total del 48 elementos LED, o bien 11 x 93757
- ▶ Le dimensioni del prodotto si adattano perfettamente alle attuali misure delle piastrelle
- ▶ L'apparecchio può essere installato verticalmente o orizzontalmente sia nei punti di incrocio delle piastrelle che in fughe strette da 3mm (il cavo può essere sistemato diagonalmente).
- ▶ Il set di base è espandibile fino ad un totale di 48 elementi LED (11 x 93757)



Transparent Transparente Trasparente

**incl. 4x0,02 W**  
 4x0,4 lm, 2.700 K  
 230 V, incl. 3 VA  
 EAN 4000870 937563  
**937.56**

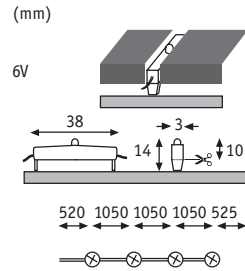

**Special Line GrooveLight Extra** Plastic Plástico Plastica

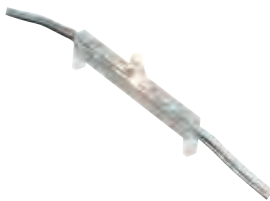

Transparent Transparente Trasparente

**incl. 4x0,02 W**  
 4x0,4 lm, 2.700 K  
 6 V  
 EAN 4000870 937570  
**937.57**

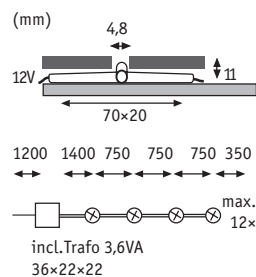

### Special Line Crosslight Basic

Plastic Plástico Plastica

- ▶ Basic set can be extended by the auxiliary set to up to 12 light points
- ▶ Tile joint can also be installed afterwards
- ▶ El juego básico puede ampliarse con el juego complementario hasta a 12 puntos de luz
- ▶ La intersección de baldosas puede instalarse también posteriormente
- ▶ Set di base ampliabile fino a 12 punti luce mediante set aggiuntivo
- ▶ Crosslight per piastrelle montabili anche in un momento successivo



Black Negro Nero

**incl. 4x0,275 W**

20.000 K

230/12 V, incl. 3,6 VA

EAN 4000870 987681

**987.68**

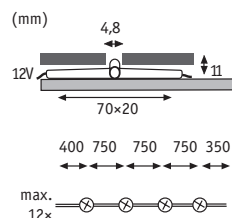

### Special Line Crosslight Extra

Plastic Plástico Plastica



Black Negro Nero

**incl. 4x0,275 W**

20.000 K

DC 12 V

EAN 4000870 987728

**987.72**





000

## Downlights | Floor

Recessed floor luminaires for indoors and out. Several recessed luminaires in the floor provide orientation in the dark. Ideal for highlighting and differentiating areas both indoors and outside of the house.

Luminarias empotrables en el suelo para interiores y exteriores. La instalación de varias luminarias empotrables en el suelo facilita la orientación en la oscuridad. Ideales para la puesta en escena y delimitación de zonas en el interior y en el exterior delante de la casa.

Faretti da incasso a pavimento per interno ed esterno. Numerosi faretti da incasso a pavimento permettono di orientarsi al buio. Ideali per la messa in risalto e la delimitazione di ambienti all'interno e all'esterno, di fronte alla casa.

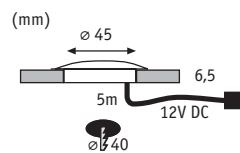
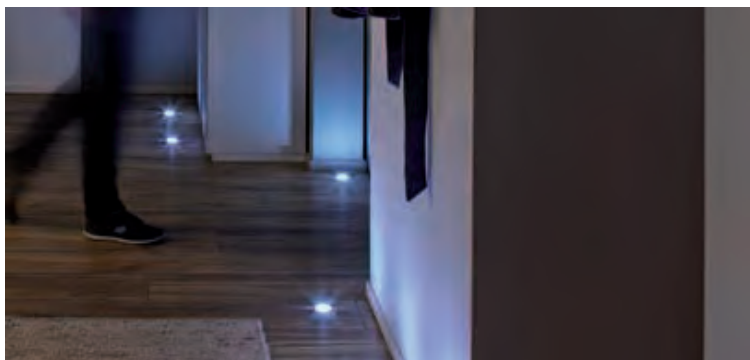

**Special Line LED Allround** Plastic/Stainless steel Plástico/Acero inoxidable Plastica/Acciaio legato

- ▶ Dust- and waterproof (IP67)
- ▶ The parquet thickness is sufficient for the installation depth
- ▶ Hermético al polvo y protegido frente a inmersión en agua (IP67)
- ▶ Como profundidad de empotrado basta el grosor del parquet
- ▶ Protezione da penetrazione di polvere e breve immersione in acqua (IP67)
- ▶ Come profondità di incasso è sufficiente lo spessore del parquet



Transparent Transparente Trasparente

<b>incl. 1x0,7 W</b> <A++-A	<b>incl. 3x0,7 W</b> <A++-A
48 lm, 4.000 K	3x48 lm, 4.000 K
∠ 100°	∠ 100°
DC 12 V	230/12 V, incl. 3,6 VA
EAN 4000870 938270	EAN 4000870 938287
<b>938.27</b>	<b>938.28</b>



Satin Satinado Satinato

<b>incl. 1x0,7 W</b> <A++-A	<b>incl. 3x0,7 W</b> <A++-A
32 lm, 2.700 K	3x32 lm, 2.700 K
∠ 110°	∠ 110°
DC 12 V	230/12 V, incl. 3,6 VA
EAN 4000870 938294	EAN 4000870 938300
<b>938.29</b>	<b>938.30</b>

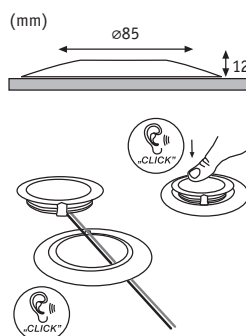

**Special Line Allround Mounting ring round** Stainless steel Acero inoxidable Acciaio legato

- ▶ Surface-mounted ring for installation on e.g. stone, concrete, carpet
- ▶ Anillo de fijación para instalar p.ej. sobre piedra, hormigón, moqueta
- ▶ Anello di montaggio per l'installazione su pietra, cemento, moquette ecc.

Stainless steel Acero inoxidable Acciaio legato



EAN 4000870 938317  
**938.31**

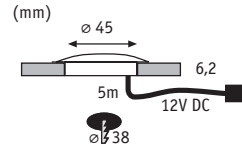

LED	IP67
130	Polycarbonate
	rostfref

**Special Line UpDownlight**

Polycarbonate Polycarbonato Policarbonato

- ▶ Dust- and waterproof (IP67)
- ▶ The parquet thickness is sufficient for the installation depth
- ▶ Hermético al polvo y protegido frente a inmersión en agua (IP67)
- ▶ Como profundidad de empotrado basta el grosor del parquet
- ▶ Protezione da penetrazione di polvere e breve immersione in acqua (IP67)
- ▶ Come profondità di incasso è sufficiente lo spessore del parquet

Transparent Transparente Trasparente



**incl. 1x1 W**  
6.500 K  
∠ 120°, 13 cd  
DC 12 V  
EAN 4000870 987919  
**987.91**

Satin Satinado Satinato



**incl. 1x1 W**  
6.500 K  
∠ 120°, 13 cd  
DC 12 V  
EAN 4000870 987568  
**987.56**

**incl. 1x1 W**  
3.000 K  
∠ 120°, 13 cd  
DC 12 V  
EAN 4000870 937006  
**937.00**

000

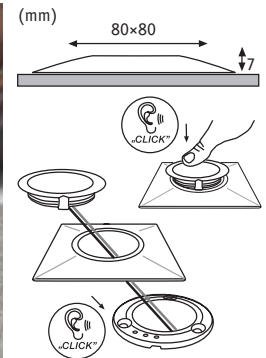
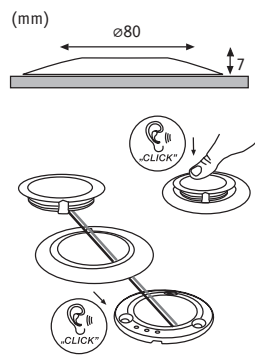

- ▶ Surface-mounted ring for installation on e.g. stone, concrete, carpet
- ▶ Anillo de fijación para instalar p.ej. sobre piedra, hormigón, moqueta
- ▶ Anello di montaggio per l'installazione su pietra, cemento, moquette ecc.

**Special Line UpDownlight Mounting ring round**

Aluminium zinc Aluminio cinc Alluminio zincato

Chrome matt Cromo mate Cromo opaco

Brushed iron Hierro mateado Ferro spazzolato



EAN 4000870 987773  
**987.77**



EAN 4000870 987810  
**987.81**

ALU  
rostfref

**Special Line UpDownlight Mounting ring square**

Aluminium zinc Aluminio cinc Alluminio zincato

Chrome matt Cromo mate Cromo opaco

Brushed iron Hierro mateado Ferro spazzolato



EAN 4000870 987797  
**987.79**



EAN 4000870 987827  
**987.82**

ALU  
rostfref

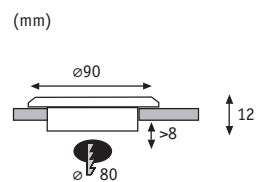

LED	IP44
140	kg
Stainless Steel rostfrei	☀
	☐

**Special Line Deco UpDownlight** Stainless steel/Polycarbonate Acero inoxidable/Polycarbonato Acciaio legato/Polycarbonato

- ▶ Easy to mount: attached using adhesive film
- ▶ Montaje sencillo: fijación con lámina adhesiva
- ▶ Montaggio semplice: fissaggio mediante pellicola adesiva



Stainless steel/Satin Acero inoxidable/Satinado Acciaio legato/Satinato

**incl. 3×1 W** A++-A

3×13 lm, 2.700 K  
 <math>\angle 120^\circ</math>, 4 cd  
 230 V, incl.  $\text{⚡}$  3,6 VA  
 EAN 4000870 937686  
**937.68**







## Downlights | Ceiling

Recessed luminaires provide pure light, whilst the visual presence of the luminaire is kept discreet. Whether used as basic lighting or to accentuate, these light sources are as decorative as they are practical.

Luminarias empotrables en el techo para la iluminación moderna de interiores.

Las luminarias empotrables proporcionan una luz pura con una presencia visual discreta de la luminaria. Son unas fuentes de luz tan decorativas como prácticas, ya sea como luz de fondo o para crear acentos.

Faretti da incasso a soffitto per illuminazione moderna d'atmosfera.

Le lampade da incasso offrono luce pura e allo stesso tempo la loro presenza è discreta. Si possono utilizzare per l'illuminazione generale o per porre accenti luminosi e sono anche luci decorative e pratiche.

Stropní vestavbová svítidla pro moderní osvětlení interiéru.



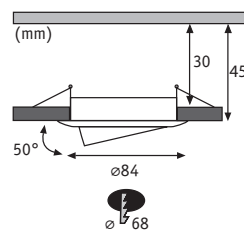

939.48

LED □ = 414-452

**Premium Reflector Coin 230V**

Aluminium zinc / Aluminio cinc / Alluminio zincato



White/Chrome / Blanco/Cromo / Bianco/Cromo

**incl. 1×6,8 W, A+1** < A++-A

450 lm, 2.700 K

∠ 38°

230 V

EAN 4000870 939451

**939.45 new****incl. 3×6,8 W, A+1** < A++-A

3×450 lm, 2.700 K

∠ 38°

230 V

EAN 4000870 939420

**939.42 new**

Turned aluminium / Aluminio torneado / Alluminio tornito

**incl. 1×6,8 W, A+1** < A++-A

450 lm, 2.700 K

∠ 38°

230 V

EAN 4000870 939451

**939.46 new****incl. 3×6,8 W, A+1** < A++-A

3×450 lm, 2.700 K

∠ 38°

230 V

EAN 4000870 939437

**939.43 new**

Brushed iron / Hierro mateado / Ferro spazzolato

**incl. 1×6,8 W, A+1** < A++-A

450 lm, 2.700 K

∠ 38°

230 V

EAN 4000870 939475

**939.47 new****incl. 3×6,8 W, A+1** < A++-A

3×450 lm, 2.700 K

∠ 38°

230 V

EAN 4000870 939444

**939.44 new****Smart Home** □ = 386-403

Comfortably control your lighting with your smart phone or remote control, using the additional products from the Smart Home chapter (P. 386-403).

Controle su luz cómodamente mediante el smartphone o el mando a distancia con los productos complementarios del capítulo Smart Home (p. 386-403)

Comandate le vostre luci comodamente utilizzando lo smartphone o il telecomando con i prodotti supplementari del capitolo Smart Home (pag. 386-403).

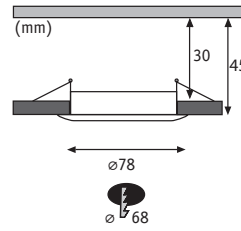

938.84  
LED □= 414-452

**Premium LED 230V Slim Coin Satin 51mm** Aluminium zinc Aluminio cinc Alluminio zincato



Matt white Blanco mate Bianco opaco

**incl. 1×6,8 W**

A++-A

592 lm, 2.700 K  
230 V  
EAN 4000870 938577  
**938.57 new**

**incl. 3×6,8 W**

A++-A

3×592 lm, 2.700 K  
230 V  
EAN 4000870 938584  
**938.58 new**



Brushed iron Hierro mateado Ferro spazzolato

**incl. 1×6,8 W**

A++-A

592 lm, 2.700 K  
230 V  
EAN 4000870 938591  
**938.59 new**

**incl. 3×6,8 W**

A++-A

3×592 lm, 2.700 K  
230 V  
EAN 4000870 938607  
**938.60 new**



Chrome Cromo Cromo

**incl. 1×6,8 W**

A++-A

592 lm, 2.700 K  
230 V  
EAN 4000870 938614  
**938.61 new**

**incl. 3×6,8 W**

A++-A

3×592 lm, 2.700 K  
230 V  
EAN 4000870 938621  
**938.62 new**



Turned aluminium Aluminio torneado Alluminio tornito

**incl. 1×6,8 W**

A++-A

592 lm, 2.700 K  
230 V  
EAN 4000870 938966  
**938.96 new**

**incl. 3×6,8 W**

A++-A

3×592 lm, 2.700 K  
230 V  
EAN 4000870 938973  
**938.97 new**

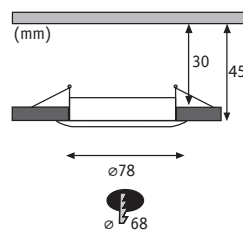

938.85

LED □= 414-452

**Premium LED 230V Slim Coin Satin 51mm dimmable** □ Aluminium zinc Aluminio cinc Alluminio zincato



☞ Matt white Blanco mate Bianco opaco

**incl. 1×6,8 W**

◀ A++-A

633 lm, 2.700 K

230 V

EAN 4000870 938690

**938.69 new**

**incl. 3×6,8 W**

◀ A++-A

3×633 lm, 2.700 K

230 V

EAN 4000870 938706

**938.70 new**



☞ Brushed iron Hierro mateado Ferro spazzolato

**incl. 1×6,8 W**

◀ A++-A

633 lm, 2.700 K

230 V

EAN 4000870 938713

**938.71 new**

**incl. 3×6,8 W**

◀ A++-A

3×633 lm, 2.700 K

230 V

EAN 4000870 938737

**938.73 new**



☞ Chrome Cromo Cromo

**incl. 1×6,8 W**

◀ A++-A

633 lm, 2.700 K

230 V

EAN 4000870 938720

**938.72 new**

**incl. 3×6,8 W**

◀ A++-A

3×633 lm, 2.700 K

230 V

EAN 4000870 938744

**938.74 new**



☞ Turned aluminium Aluminio torneado Alluminio tornito

**incl. 1×6,8 W**

◀ A++-A

633 lm, 2.700 K

230 V

EAN 4000870 939000

**939.00 new**

**incl. 3×6,8 W**

◀ A++-A

3×633 lm, 2.700 K

230 V

EAN 4000870 939017

**939.01 new**

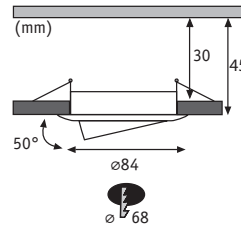

938.84  
LED □= 414-452

**Premium LED 230V Slim Coin Satin 51mm** □ Aluminium zinc Aluminio cinc Alluminio zincato



☞ Matt white Blanco mate Bianco opaco

<b>incl. 1×6,8 W</b> < A++-A	<b>incl. 3×6,8 W</b> < A++-A
592 lm, 2.700 K	3×592 lm, 2.700 K
230 V	230 V
EAN 4000870 938638	EAN 4000870 938645
<b>938.63 new</b>	<b>938.64 new</b>



☞ Brushed iron Hierro mateado Ferro spazzolato

<b>incl. 1×6,8 W</b> < A++-A	<b>incl. 3×6,8 W</b> < A++-A
592 lm, 2.700 K	3×592 lm, 2.700 K
230 V	230 V
EAN 4000870 938669	EAN 4000870 938652
<b>938.66 new</b>	<b>938.65 new</b>



☞ Chrome Cromo Cromo

<b>incl. 1×6,8 W</b> < A++-A	<b>incl. 3×6,8 W</b> < A++-A
592 lm, 2.700 K	3×592 lm, 2.700 K
230 V	230 V
EAN 4000870 938676	EAN 4000870 938683
<b>938.67 new</b>	<b>938.68 new</b>



☞ Turned aluminium Aluminio torneado Alluminio tornito

<b>incl. 1×6,8 W</b> < A++-A	<b>incl. 3×6,8 W</b> < A++-A
592 lm, 2.700 K	3×592 lm, 2.700 K
230 V	230 V
EAN 4000870 938980	EAN 4000870 938997
<b>938.98 new</b>	<b>938.99 new</b>

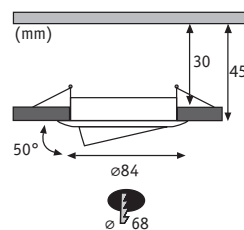

938.85

LED □= 414-452

**Premium LED 230V Slim Coin Satin 51mm dimmable** □ Aluminium zinc Aluminio cinc Alluminio zincato



☞ Matt white Blanco mate Bianco opaco

**incl. 1×6,8 W**

◀ A++-A

633 lm, 2.700 K

230 V

EAN 4000870 938768

**938.76 new**

**incl. 3×6,8 W**

◀ A++-A

3×633 lm, 2.700 K

230 V

EAN 4000870 938751

**938.75 new**



☞ Brushed iron Hierro mateado Ferro spazzolato

**incl. 1×6,8 W**

◀ A++-A

633 lm, 2.700 K

230 V

EAN 4000870 938775

**938.77 new**

**incl. 3×6,8 W, A++**

◀ A++-A

3×633 lm, 2.700 K

∠ 38°

230 V

EAN 4000870 938782

**938.78 new**



☞ Chrome Cromo Cromo

**incl. 1×6,8 W**

◀ A++-A

633 lm, 2.700 K

230 V

EAN 4000870 938799

**938.79 new**

**incl. 3×6,8 W**

◀ A++-A

3×633 lm, 2.700 K

230 V

EAN 4000870 938805

**938.80 new**



☞ Turned aluminium Aluminio torneado Alluminio tornito

**incl. 1×6,8 W, A++**

◀ A++-A

633 lm, 2.700 K

∠ 38°

230 V

EAN 4000870 939024

**939.02 new**

**incl. 3×6,8 W**

◀ A++-A

3×633 lm, 2.700 K

230 V

EAN 4000870 939031

**939.03 new**



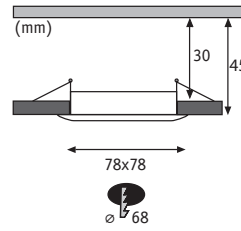

938.85  
LED □= 414-452

**Premium LED 230V Slim Coin Satin 51mm dimmable** □ Aluminium zinc Aluminio cinc Alluminio zincato



☞ Matt white Blanco mate Bianco opaco

**incl. 1×6,8 W**

◀ A++-A

633 lm, 2.700 K  
230 V  
EAN 4000870 938881  
**938.88 new**

**incl. 3×6,8 W**

◀ A++-A

3×633 lm, 2.700 K  
230 V  
EAN 4000870 938898  
**938.89 new**



☞ Brushed iron Hierro mateado Ferro spazzolato

**incl. 1×6,8 W**

◀ A++-A

633 lm, 2.700 K  
230 V  
EAN 4000870 938911  
**938.91 new**

**incl. 3×6,8 W**

◀ A++-A

3×633 lm, 2.700 K  
230 V  
EAN 4000870 938904  
**938.90 new**



☞ Chrome Cromo Cromo

**incl. 1×6,8 W**

◀ A++-A

633 lm, 2.700 K  
230 V  
EAN 4000870 938928  
**938.92 new**

**incl. 3×6,8 W**

◀ A++-A

3×633 lm, 2.700 K  
230 V  
EAN 4000870 938935  
**938.93 new**

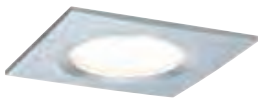

☞ Turned aluminium Aluminio torneado Alluminio tornito

**incl. 1×6,8 W**

◀ A++-A

633 lm, 2.700 K  
230 V  
EAN 4000870 938942  
**938.94 new**

**incl. 3×6,8 W**

◀ A++-A

3×633 lm, 2.700 K  
230 V  
EAN 4000870 938959  
**938.95 new**

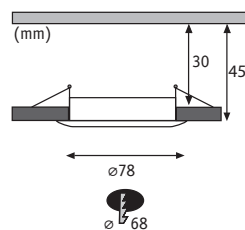

938.85

LED □= 414-452

**Premium LED IP65 230V Slim Coin Satin 51mm dimmable**

Aluminium zinc Aluminium zinc Alluminio zincato



Matt white Blanco mate Bianco opaco

**incl. 1×6,8 W** < A++-A

633 lm, 2.700 K

230 V

EAN 4000870 938812

**938.81 new**



Brushed iron Hierro mateado Ferro spazzolato

**incl. 1×6,8 W** < A++-A

633 lm, 2.700 K

230 V

EAN 4000870 938829

**938.82 new**



Chrome Cromo Cromo

**incl. 1×6,8 W** < A++-A

633 lm, 2.700 K

230 V

EAN 4000870 938836

**938.83 new**



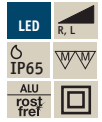
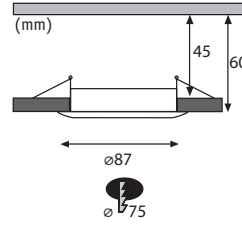

938.36  
LED □= 414-452

**Premium Line LED IP65 230V Coin 51mm**    Aluminium zinc    Aluminio cinc    Alluminio zincato

- ▶ Protected from spray water and water jets (IP65)
- ▶ Glare-free due to recessed lamp
- ▶ Protección contra chorros de agua y agua proyectada (IP65)
- ▶ No deslumbra gracias a la luminaria dispuesta más atrás
- ▶ Protezione da spruzzi e getti d'acqua (IP65)
- ▶ Anabagliante grazie a lampadina in posizione arretrata



White/Satin    Blanco/Satinado    Bianco/Satinato

**incl. 1x7 W, A+**    A+-A  
380 lm, 2.700 K  
∠ 105°  
230 V  
EAN 4000870 928462  
**928.46**

**incl. 3x7 W, A+**    A+-A  
3x380 lm, 2.700 K  
∠ 105°  
230 V  
EAN 4000870 928479  
**928.47**



Brushed iron/Satin    Hierro mateado/Satinado    Ferro spazzolato/Satinato

**incl. 1x7 W, A+**    A+-A  
380 lm, 2.700 K  
∠ 105°  
230 V  
EAN 4000870 928486  
**928.48**

**incl. 3x7 W, A+**    A+-A  
3x380 lm, 2.700 K  
∠ 105°  
230 V  
EAN 4000870 928493  
**928.49**



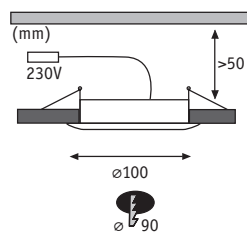

### Premium Line LED 230V Coin 75mm

Aluminium zinc / Aluminio cinc / Alluminio zincato

- ▶ Shallow installation depth
- ▶ With safety glass
- ▶ Incl. junction box with double quick clamp for feeding through wires
- ▶ Mínima profundidad de empotre
- ▶ Con vidrio protector
- ▶ Incluye caja de conexión con conector rápido doble para paso de cable
- ▶ Profondità minima di incasso ridotta
- ▶ Con vetro di protezione
- ▶ Scatola di connessione con clip rapida doppia per il passaggio dei cavi



Matt white/Clear / Blanco mate/Transparente / Bianco opaco/Trasparente

**incl. 1x14 W, A+** < A+-A

830 lm, 2.700 K

∠ 110°

230 V

EAN 4000870 927816

**927.81**



Brushed iron/Clear / Hierro mateado/Transparente / Ferro spazzolato/Trasparente

**incl. 1x14 W, A+** < A+-A

830 lm, 2.700 K

∠ 110°

230 V

EAN 4000870 927823

**927.82**



Chrome/Clear / Cromo/Transparente / Cromo/Trasparente

**incl. 1x14 W, A+** < A+-A

830 lm, 2.700 K

∠ 110°

230 V

EAN 4000870 927830

**927.83**

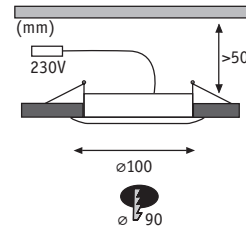

**Premium Line LED 230V Coin 75mm**

Aluminium zinc / Aluminio cinc / Alluminio zincato

- ▶ Shallow installation depth
- ▶ With safety glass
- ▶ Incl. junction box with double quick clamp for feeding through wires
- ▶ Mínima profundidad de empotre
- ▶ Con vidrio protector
- ▶ Incluye caja de conexión con conector rápido doble para paso de cable
- ▶ Profondità minima di incasso ridotta
- ▶ Con vetro di protezione
- ▶ Scatola di connessione con clip rapida doppia per il passaggio dei cavi



Matt white/Satin Blanco mate/Satinado Bianco opaco/Satinato

**incl. 1x14 W, A+** < A+-A

830 lm, 2.700 K

∠ 110°

230 V

EAN 4000870 927861

**927.86**



Brushed iron/Satin Hierro mateado/Satinado Ferro spazzolato/Satinato

**incl. 1x14 W, A+** < A+-A

830 lm, 2.700 K

∠ 110°

230 V

EAN 4000870 927878

**927.87**



Chrome/Satin Cromo/Satinado Cromo/Satinato

**incl. 1x14 W, A+** < A+-A

830 lm, 2.700 K

∠ 110°

230 V

EAN 4000870 927885

**927.88**

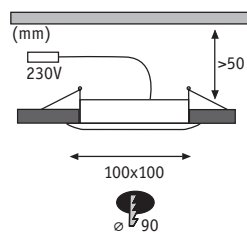

**Premium Line LED 230V Coin 75mm**

Aluminium zinc / Aluminio cinc / Alluminio zincato

- |  |   |   |
|--|---|---|
| ▶ Shallow installation depth   | ▶ Mínima profundidad de empotre   | ▶ Profondità minima di incasso ridotta                                    |
| ▶ With safety glass  | ▶ Con vidrio protector  | ▶ Con vetro di protezione   |
| ▶ Incl. junction box with double quick clamp for feeding through wires | ▶ Incluye caja de conexión con conector rápido doble para paso de cable | ▶ Scatola di connessione con clip rapida doppia per il passaggio dei cavi |



Brushed iron/Clear / Hierro mateado/Transparente / Ferro spazzolato/Trasparente

**incl. 1x14 W, A+** < A+-A

830 lm, 2.700 K

∠ 110°

230 V

EAN 4000870 927847

**927.84**

Chrome/Clear / Cromo/Transparente / Cromo/Trasparente

**incl. 1x14 W, A+** < A+-A

830 lm, 2.700 K

∠ 110°

230 V

EAN 4000870 927854

**927.85**

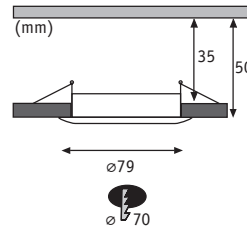

938.19  
LED □ = 414-452

**LED 230V Coin 51mm**

Aluminium zinc / Aluminio cinc / Alluminio zincato



Matt white/Satin / Blanco mate/Satinado / Bianco opaco/Satinato

**incl. 1×6,8 W, A++** A++-A

535 lm, 2.700 K

∠ 160°

230 V

EAN 4000870 939734

**939.73 new**

**incl. 3×6,8 W, A++** A++-A

3×535 lm, 2.700 K

∠ 160°

230 V

EAN 4000870 939741

**939.74 new**



Brushed iron/Satin / Hierro mateado/Satinado / Ferro spazzolato/Satinato

**incl. 1×6,8 W, A++** A++-A

535 lm, 2.700 K

∠ 160°

230 V

EAN 4000870 939758

**939.75 new**

**incl. 3×6,8 W, A++** A++-A

3×535 lm, 2.700 K

∠ 160°

230 V

EAN 4000870 939765

**939.76 new**



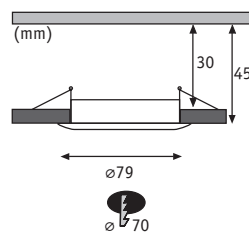

938.36

LED □= 414-452

LED 230V Coin 51mm dimmable

Aluminium zinc Aluminium cinc Alluminio zincato



Matt white/Satin Blanco mate/Satinado Bianco opaco/Satinato

incl. 1×7 W, A+ A+-A

482 lm, 2.700 K

∠ 105°

230 V

EAN 4000870 939550

939.55 new

incl. 3×7 W, A+ A+-A

3×482 lm, 2.700 K

∠ 105°

230 V

EAN 4000870 939567

939.56 new



Brushed iron/Satin Hierro mateado/Satinado Ferro spazzolato/Satinato

incl. 1×7 W, A+ A+-A

482 lm, 2.700 K

∠ 105°

230 V

EAN 4000870 939574

939.57 new

incl. 3×7 W, A+ A+-A

3×482 lm, 2.700 K

∠ 105°

230 V

EAN 4000870 939581

939.58 new



Chrome/Satin Cromo/Satinado Cromo/Satinato

incl. 1×7 W, A+ A+-A

482 lm, 2.700 K

∠ 105°

230 V

EAN 4000870 939598

939.59 new

incl. 3×7 W, A+ A+-A

3×482 lm, 2.700 K

∠ 105°

230 V

EAN 4000870 939604

939.60 new

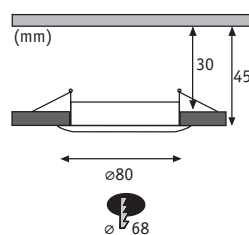

938.36

LED □= 414-452

LED 230V Coin 51mm dimmable

Aluminium Aluminium Alluminio



Turned aluminium/Satin Aluminium torneado/Satinado Alluminio tornito/Satinato

incl. 1×7 W, A+ A+-A

482 lm, 2.700 K

∠ 105°

230 V

EAN 4000870 939673

939.67 new

incl. 3×7 W, A+ A+-A

3×482 lm, 2.700 K

∠ 105°

230 V

EAN 4000870 939680

939.68 new

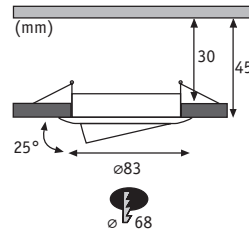

938.19  
LED □= 414-452

LED 230V Coin 51mm

Aluminium zinc Aluminium cinc Alluminio zincato



Matt white/Satin Blanco mate/Satinado Bianco opaco/Satinato

**incl. 1×6,8 W, A+ A+-A**

535 lm, 2.700 K

∠ 160°

230 V

EAN 4000870 939772

**939.77 new**

**incl. 3×6,8 W, A+ A+-A**

3×535 lm, 2.700 K

∠ 160°

230 V

EAN 4000870 939789

**939.78 new**



Brushed iron/Satin Hierro mateado/Satinado Ferro spazzolato/Satinato

**incl. 1×6,8 W, A+ A+-A**

535 lm, 2.700 K

∠ 160°

230 V

EAN 4000870 939796

**939.79 new**

**incl. 3×6,8 W, A+ A+-A**

3×535 lm, 2.700 K

∠ 160°

230 V

EAN 4000870 939802

**939.80 new**



Chrome/Satin Cromo/Satinado Cromo/Satinato

**incl. 1×6,8 W, A+ A+-A**

535 lm, 2.700 K

∠ 160°

230 V

EAN 4000870 939819

**939.81 new**

**incl. 3×6,8 W, A+ A+-A**

3×535 lm, 2.700 K

∠ 160°

230 V

EAN 4000870 939826

**939.82 new**

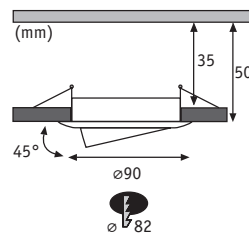

938.19  
LED □= 414-452

LED 230V Coin 51mm

Aluminium Aluminium Alluminio



Turned aluminium/Satin Aluminium torneado/Satinado Alluminio tornito/Satinato

**incl. 1×6,8 W, A+ A+-A**

535 lm, 2.700 K

∠ 160°

230 V

EAN 4000870 939833

**939.83 new**

**incl. 3×6,8 W, A+ A+-A**

3×535 lm, 2.700 K

∠ 160°

230 V

EAN 4000870 939840

**939.84 new**

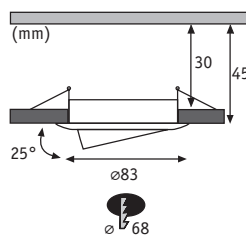

938.36  
LED □= 414-452

LED 230V Coin 51mm dimmable

Aluminium zinc Aluminium cinc Alluminio zincato

Matt white/Satin Blanco mate/Satinado Bianco opaco/Satinato



<b>incl. 1×7 W, A+</b> < A+-A	<b>incl. 3×7 W, A+</b> < A+-A
482 lm, 2.700 K	3×482 lm, 2.700 K
∠ 105°	∠ 105°
230 V	230 V
EAN 4000870 939611	EAN 4000870 939628
<b>939.61 new</b>	<b>939.62 new</b>

Brushed iron/Satin Hierro mateado/Satinado Ferro spazzolato/Satinato



<b>incl. 1×7 W, A+</b> < A+-A	<b>incl. 3×7 W, A+</b> < A+-A
482 lm, 2.700 K	3×482 lm, 2.700 K
∠ 105°	∠ 105°
230 V	230 V
EAN 4000870 939635	EAN 4000870 939642
<b>939.63 new</b>	<b>939.64 new</b>

Chrome/Satin Cromo/Satinado Cromo/Satinato



<b>incl. 1×7 W, A+</b> < A+-A	<b>incl. 3×7 W, A+</b> < A+-A
482 lm, 2.700 K	3×482 lm, 2.700 K
∠ 105°	∠ 105°
230 V	230 V
EAN 4000870 939659	EAN 4000870 939666
<b>939.65 new</b>	<b>939.66 new</b>

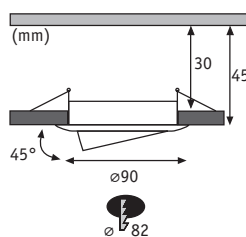

938.36  
LED □= 414-452

LED 230V Coin 51mm dimmable

Aluminium Aluminium Alluminio

Turned aluminium/Satin Aluminium torneado/Satinado Alluminio tornito/Satinato



<b>incl. 1×7 W, A+</b> < A+-A	<b>incl. 3×7 W, A+</b> < A+-A
482 lm, 2.700 K	3×482 lm, 2.700 K
∠ 105°	∠ 105°
230 V	230 V
EAN 4000870 939697	EAN 4000870 939703
<b>939.69 new</b>	<b>939.70 new</b>



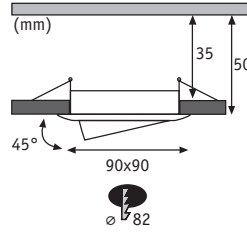

938.19  
LED □= 414-452

**LED 230V Coin 51mm**

Aluminium Aluminium Alluminio



Turned aluminium/Satin Aluminium torneado/Satinado Alluminio tornito/Satinato

**incl. 1×6,8 W, A+ A+-A**

535 lm, 2.700 K

∠ 160°

230 V

EAN 4000870 939857

**939.85 new**

**incl. 3×6,8 W, A+ A+-A**

3×535 lm, 2.700 K

∠ 160°

230 V

EAN 4000870 939864

**939.86 new**

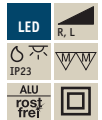
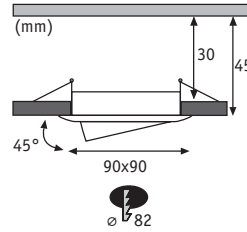

938.36  
LED □= 414-452

**LED 230V Coin 51mm dimmable**

Aluminium Aluminium Alluminio



Turned aluminium/Satin Aluminium torneado/Satinado Alluminio tornito/Satinato

**incl. 1×7 W, A+ A+-A**

482 lm, 2.700 K

∠ 105°

230 V

EAN 4000870 939710

**939.71 new**

**incl. 3×7 W, A+ A+-A**

3×482 lm, 2.700 K

∠ 105°

230 V

EAN 4000870 939727

**939.72 new**

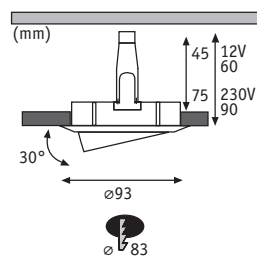

GU5,3 / GU10

LED □= 414-452

12V □= 459-462



Premium Nova IP65 adjustable GU10/GU5,3 □ Aluminium zinc Aluminio cinc Alluminio zincato



☞ Matt white Blanco mate Bianco opaco

max. 35 W < A++-E

EAN 4000870 936610

936.61 new



☞ Brushed iron Hierro mateado Ferro spazzolato

max. 35 W < A++-E

EAN 4000870 936627

936.62 new

Trafo/Power Supply □= 404-414

Accessories □= 381-385

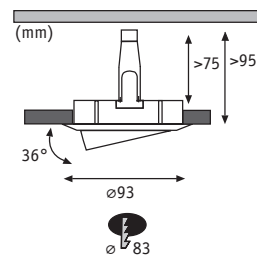

GU10

LED □= 414-452

Premium Nova IP65 adjustable GU10/GU5,3 □ Aluminium zinc Aluminio cinc Alluminio zincato



☞ Matt white Blanco mate Bianco opaco

incl. 1x7 W, < A++-E

460 lm, 2.700 K

230 V

EAN 4000870 928974

928.97 new

incl. 3x7 W, < A++-E

3x460 lm, 2.700 K

230 V

EAN 4000870 928981

928.98 new



☞ Brushed iron Hierro mateado Ferro spazzolato

incl. 1x7 W, < A++-E

460 lm, 2.700 K

230 V

EAN 4000870 928998

928.99 new

incl. 3x7 W, < A++-E

3x460 lm, 2.700 K

230 V

EAN 4000870 929001

929.00 new

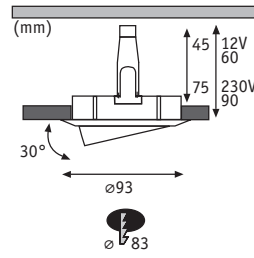

GU5,3 / GU10

LED □= 414-452  
12V □= 459-462

Premium Nova IP65 adjustable GU10/GU5,3 Aluminium zinc / Aluminio cinc / Alluminio zincato



Matt white/Chrome / Blanco mate/Cromo / Bianco opaco/Cromo

max. 35 W A++-E  
EAN 4000870 936634  
936.63 new

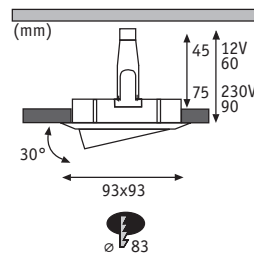

GU5,3 / GU10

LED □= 414-452  
12V □= 459-462

Premium Nova IP65 adjustable GU10/GU5,3 Aluminium zinc / Aluminio cinc / Alluminio zincato



Matt white/Chrome / Blanco mate/Cromo / Bianco opaco/Cromo

max. 35 W A++-E  
EAN 4000870 936641  
936.64 new

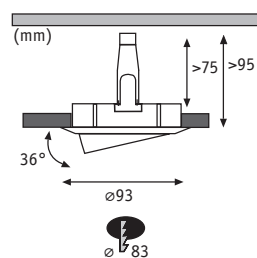

GU10  
LED □= 414-452

**Premium Nova IP65 adjustable GU10/GU5.3** □ Aluminium zinc Aluminio cinc Alluminio zincato



⌘ Matt white/Chrome Blanco mate/Cromo Bianco opaco/Cromo

incl. 1×7 W, A++ < A++-E

460 lm, 2.700 K

230 V

EAN 4000870 929032

929.03 new

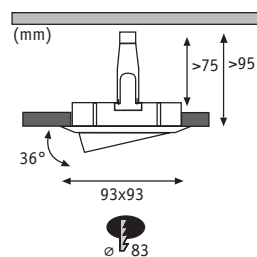

GU10  
LED □= 414-452

**Premium Nova IP65 adjustable GU10/GU5.3** □ Aluminium zinc Aluminio cinc Alluminio zincato



⌘ Matt white/Chrome Blanco mate/Cromo Bianco opaco/Cromo

incl. 1×7 W, A++ < A++-E

460 lm, 2.700 K

230 V

EAN 4000870 929049

929.04 new

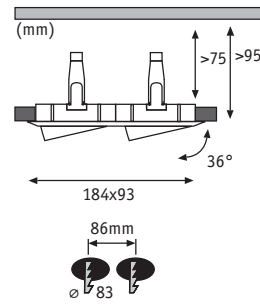

GU10

LED □= 414-452

Premium Nova IP65 adjustable GU10/GU5,3 Aluminium zinc / Aluminio cinc / Alluminio zincato



Matt white/Chrome / Blanco mate/Cromo / Bianco opaco/Cromo

**incl. 1x (2x7 W), A++-E**

1x 2x460 lm, 2.700 K

230 V

EAN 4000870 929018

**929.01 new**

000

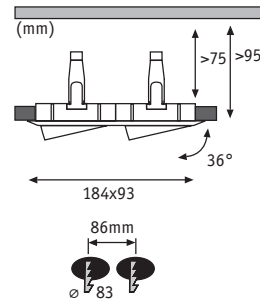

GU10

LED □= 414-452

Premium Nova IP65 adjustable GU10/GU5,3 Aluminium zinc / Aluminio cinc / Alluminio zincato



Matt white/Chrome / Blanco mate/Cromo / Bianco opaco/Cromo

**incl. 1x (2x7 W), A++-E**

1x 2x460 lm, 2.700 K

230 V

EAN 4000870 929025

**929.02 new**



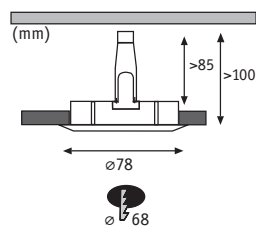

GU10

282.06  
283.45

LED □= 414-452

**Premium LED Nova IP65 230V GU10 51mm dimmable** □ Aluminium zinc Aluminio cinc Alluminio zincato



☞ Matt white Blanco mate Bianco opaco

**incl. 1×7 W, A<sup>+</sup>** < A<sup>++</sup>-E

460 lm, 2.700 K

230 V

EAN 4000870 936252

**936.25 new**

☞ Brushed iron Hierro mateado Ferro spazzolato

**incl. 1×7 W, A<sup>+</sup>** < A<sup>++</sup>-E

460 lm, 2.700 K

230 V

EAN 4000870 936269

**936.26 new**

☞ Chrome Cromo Cromo

**incl. 1×7 W, A<sup>+</sup>** < A<sup>++</sup>-E

460 lm, 2.700 K

230 V

EAN 4000870 936276

**936.27 new**

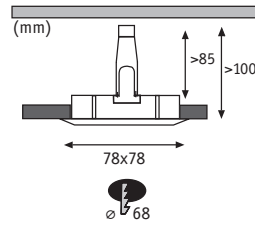

GU10

282.06  
283.45

LED □= 414-452

**Premium LED Nova IP65 230V GU10 51mm dimmable** □ Aluminium zinc Aluminio cinc Alluminio zincato



☞ Matt white Blanco mate Bianco opaco

**incl. 1x7 W, A<sup>+</sup>** < A<sup>++</sup>-E

460 lm, 2.700 K

230 V

EAN 4000870 936283

**936.28 new**



☞ Brushed iron Hierro mateado Ferro spazzolato

**incl. 1x7 W, A<sup>+</sup>** < A<sup>++</sup>-E

460 lm, 2.700 K

230 V

EAN 4000870 936290

**936.29 new**



☞ Chrome Cromo Cromo

**incl. 1x7 W, A<sup>+</sup>** < A<sup>++</sup>-E

460 lm, 2.700 K

230 V

EAN 4000870 936306

**936.30 new**



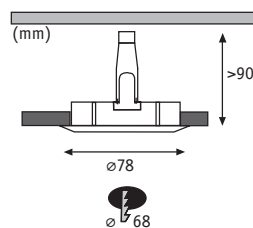

GU10  
 ⚡ 282.06  
 283.45  
 LED □= 414-452

Premium LED Nova 230V GU10 51mm dimmable

Aluminium zinc Aluminio cinc Alluminio zincato



Matt white Blanco mate Bianco opaco

max. 35 W	A++-E	incl. 1×7 W, A+	A++-E	incl. 3×7 W, A+	A++-E
230 V		460 lm, 2.700 K		3×460 lm, 2.700 K	
EAN 4000870 936313		230 V		230 V	
<b>936.31 new</b>		EAN 4000870 935934		EAN 4000870 935972	
		<b>935.93 new</b>		<b>935.97 new</b>	



Brushed iron Hierro mateado Ferro spazzolato

max. 35 W	A++-E	incl. 1×7 W, A+	A++-E	incl. 3×7 W, A+	A++-E
230 V		460 lm, 2.700 K		3×460 lm, 2.700 K	
EAN 4000870 936337		230 V		230 V	
<b>936.33 new</b>		EAN 4000870 935958		EAN 4000870 935996	
		<b>935.95 new</b>		<b>935.99 new</b>	



Rosé gold Oro rosa Oro rosa

max. 35 W	A++-E	incl. 1×7 W, A+	A++-E	incl. 3×7 W, A+	A++-E
230 V		460 lm, 2.700 K		3×460 lm, 2.700 K	
EAN 4000870 936344		230 V		230 V	
<b>936.34 new</b>		EAN 4000870 935965		EAN 4000870 936009	
		<b>935.96 new</b>		<b>936.00 new</b>	



Turned aluminium Aluminio torneado Alluminio tornito

max. 35 W	A++-E	incl. 1×7 W, A+	A++-E	incl. 3×7 W, A+	A++-E
230 V		460 lm, 2.700 K		3×460 lm, 2.700 K	
EAN 4000870 936320		230 V		230 V	
<b>936.32 new</b>		EAN 4000870 935941		EAN 4000870 935989	
		<b>935.94 new</b>		<b>935.98 new</b>	

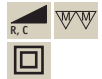
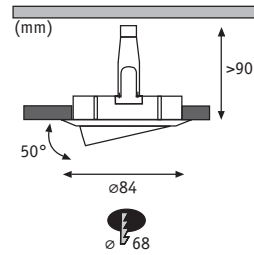

GU10  
 282.06  
 283.45  
 LED □= 414-452

**Premium LED Nova 230V GU10 51mm dimmable** □ Aluminium zinc Aluminio cinc Alluminio zincato



☞ Matt white Blanco mate Bianco opaco

<b>max. 35 W</b>	◀ A++-E	<b>incl. 1×7 W, A+</b>	◀ A++-E	<b>incl. 3×7 W, A+</b>	◀ A++-E
230 V		460 lm, 2.700 K		3×460 lm, 2.700 K	
EAN 4000870 936399		230 V		230 V	
<b>936.39 new</b>		EAN 4000870 936016		EAN 4000870 936054	
		<b>936.01 new</b>		<b>936.05 new</b>	



☞ Brushed iron Hierro mateado Ferro spazzolato

<b>max. 35 W</b>	◀ A++-E	<b>incl. 1×7 W, A+</b>	◀ A++-E	<b>incl. 3×7 W, A+</b>	◀ A++-E
230 V		460 lm, 2.700 K		3×460 lm, 2.700 K	
EAN 4000870 936412		230 V		230 V	
<b>936.41 new</b>		EAN 4000870 936030		EAN 4000870 936078	
		<b>936.03 new</b>		<b>936.07 new</b>	



☞ Rosé gold Oro rosa Oro rosa

<b>max. 35 W</b>	◀ A++-E	<b>incl. 1×7 W, A+</b>	◀ A++-E	<b>incl. 3×7 W, A+</b>	◀ A++-E
230 V		460 lm, 2.700 K		3×460 lm, 2.700 K	
EAN 4000870 936429		230 V		230 V	
<b>936.42 new</b>		EAN 4000870 936047		EAN 4000870 936085	
		<b>936.04 new</b>		<b>936.08 new</b>	



☞ Turned aluminium Aluminio torneado Alluminio tornito

<b>max. 35 W</b>	◀ A++-E	<b>incl. 1×7 W, A+</b>	◀ A++-E	<b>incl. 3×7 W, A+</b>	◀ A++-E
230 V		460 lm, 2.700 K		3×460 lm, 2.700 K	
EAN 4000870 936405		230 V		230 V	
<b>936.40 new</b>		EAN 4000870 936023		EAN 4000870 936061	
		<b>936.02 new</b>		<b>936.06 new</b>	

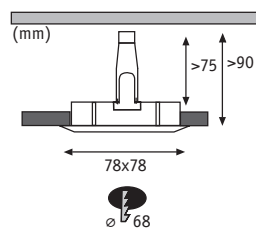

GU10

282.06  
283.45

LED □= 414-452

Premium LED Nova 230V GU10 51mm dimmable

Aluminium zinc Aluminio cinc Alluminio zincato



Matt white Blanco mate Bianco opaco

incl. 1×7 W, A+ A++-E

460 lm, 2.700 K  
230 V

EAN 4000870 936092

936.09 new

incl. 3×7 W, A+ A++-E

3×460 lm, 2.700 K  
230 V

EAN 4000870 936139

936.13 new



Brushed iron Hierro mateado Ferro spazzolato

incl. 1×7 W, A+ A++-E

460 lm, 2.700 K  
230 V

EAN 4000870 936115

936.11 new

incl. 3×7 W, A+ A++-E

3×460 lm, 2.700 K  
230 V

EAN 4000870 936153

936.15 new



Turned aluminium Aluminio torneado Alluminio tornito

incl. 1×7 W, A+ A++-E

460 lm, 2.700 K  
230 V

EAN 4000870 936108

936.10 new

incl. 3×7 W, A+ A++-E

3×460 lm, 2.700 K  
230 V

EAN 4000870 936146

936.14 new



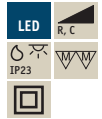
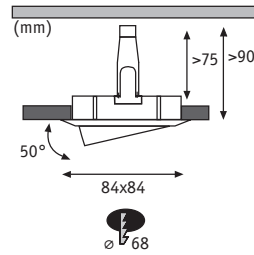

GU10  
 282.06  
 283.45  
 LED □= 414-452

**Premium LED Nova 230V GU10 51mm dimmable**

Aluminium zinc / Aluminio cinc / Alluminio zincato



🔗 Matt white / Blanco mate / Bianco opaco

**incl. 1x7 W, A++** <math>\langle A^{++}-E </math>  
 460 lm, 2.700 K  
 230 V  
 EAN 4000870 936177  
**936.17 new**

**incl. 3x7 W, A++** <math>\langle A^{++}-E </math>  
 3x460 lm, 2.700 K  
 230 V  
 EAN 4000870 936214  
**936.21 new**



🔗 Brushed iron / Hierro mateado / Ferro spazzolato

**incl. 1x7 W, A++** <math>\langle A^{++}-E </math>  
 460 lm, 2.700 K  
 230 V  
 EAN 4000870 936191  
**936.19 new**

**incl. 3x7 W, A++** <math>\langle A^{++}-E </math>  
 3x460 lm, 2.700 K  
 230 V  
 EAN 4000870 936238  
**936.23 new**



🔗 Turned aluminium / Aluminio torneado / Alluminio tornito

**incl. 1x7 W, A++** <math>\langle A^{++}-E </math>  
 460 lm, 2.700 K  
 230 V  
 EAN 4000870 936184  
**936.18 new**

**incl. 3x7 W, A++** <math>\langle A^{++}-E </math>  
 3x460 lm, 2.700 K  
 230 V  
 EAN 4000870 936221  
**936.22 new**



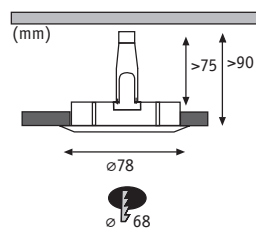

GU10  
 ⚡ 283.00  
 LED □= 414-452

### Premium Nova 230V GU10 51mm

Aluminium zinc Aluminio cinc Alluminio zincato



⌘ Matt white Blanco mate Bianco opaco

**incl. 3×5,5 W, A++** < A++-E

3×460 lm, 2.700 K

230 V

EAN 4000870 936535

**936.53 new**



⌘ Brushed iron Hierro mateado Ferro spazzolato

**incl. 3×5,5 W, A++** < A++-E

3×460 lm, 2.700 K

230 V

EAN 4000870 936542

**936.54 new**

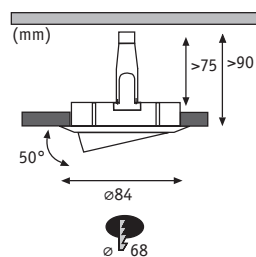

GU10  
 ⚡ 283.00  
 LED □= 414-452

### Premium Nova adjustable 230V GU10 51mm

Aluminium zinc Aluminio cinc Alluminio zincato



⌘ Matt white Blanco mate Bianco opaco

**incl. 3×5,5 W, A++** < A++-E

3×460 lm, 2.700 K

230 V

EAN 4000870 936511

**936.51 new**



⌘ Brushed iron Hierro mateado Ferro spazzolato

**incl. 3×5,5 W, A++** < A++-E

3×460 lm, 2.700 K

230 V

EAN 4000870 936528

**936.52 new**

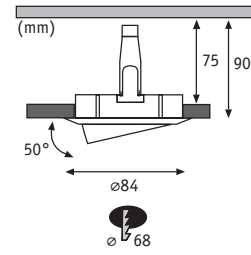

**Premium Nova Warm Dim adjustable 230V GU10 51mm** Aluminium zinc / Aluminio cinc / Alluminio zincato



Brushed iron / Hierro mateado / Ferro spazzolato

incl. 3x5 W, A++ A+-E  
 3x345 lm, 2.200 - 2.700 K  
 230 V  
 EAN 4000870 936498  
**936.49 new**

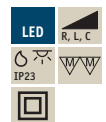
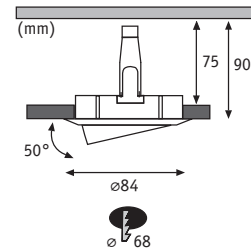

**Premium Nova Warm Dim adjustable 230V GU10 51mm** Aluminium zinc / Aluminio cinc / Alluminio zincato



Matt white/Matt champagne gold / Blanco mate/Champaña dorado mate  
 Bianco opaco/Oro champagne opaco

incl. 3x5 W, A++ A+-E  
 3x345 lm, 2.200 - 2.700 K  
 230 V  
 EAN 4000870 936504  
**936.50 new**

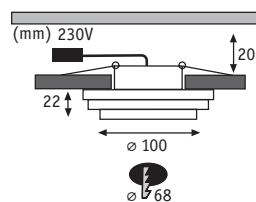

## Premium Drip

Aluminium zinc / Aluminio cinc / Alluminio zincato



White Blanco Bianco

incl. 1x8 W &lt;A++-A

650 lm, 2.700 K

∠ 60°

230 V

EAN 4000870 929131

929.13 new



White/Champagne gold / Blanco/Champaña dorado / Bianco/Oro champagne

incl. 1x8 W &lt;A++-A

650 lm, 2.700 K

∠ 60°

230 V

EAN 4000870 929148

929.14 new

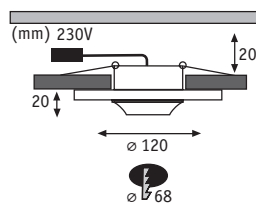

## Premium Drip

Aluminium zinc / Aluminio cinc / Alluminio zincato



White Blanco Bianco

incl. 1x8 W &lt;A++-A

650 lm, 2.700 K

∠ 60°

230 V

EAN 4000870 929117

929.11 new



White/Champagne gold / Blanco/Champaña dorado / Bianco/Oro champagne

incl. 1x8 W &lt;A++-A

650 lm, 2.700 K

∠ 60°

230 V

EAN 4000870 929124

929.12 new

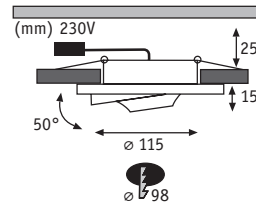

**Premium Drip 230V dimmable**

Aluminium zinc / Aluminio cinc / Alluminio zincato



White Blanco Bianco

**incl. 1x8 W** <A++-A  
650 lm, 2.700 K  
40°  
230 V  
EAN 4000870 929094  
**929.09 new**



White/Champagne gold Blanco/Champaña dorado Bianco/Oro champagne

**incl. 1x8 W** <A++-A  
650 lm, 2.700 K  
40°  
230 V  
EAN 4000870 929100  
**929.10 new**

000

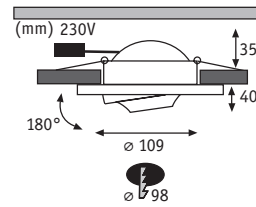

**Premium Drip**

Aluminium zinc / Aluminio cinc / Alluminio zincato



White Blanco Bianco

**incl. 1x8 W** <A++-A  
650 lm, 2.700 K  
40°  
230 V  
EAN 4000870 929155  
**929.15 new**



White/Champagne gold Blanco/Champaña dorado Bianco/Oro champagne

**incl. 1x8 W** <A++-A  
650 lm, 2.700 K  
40°  
230 V  
EAN 4000870 929162  
**929.16 new**



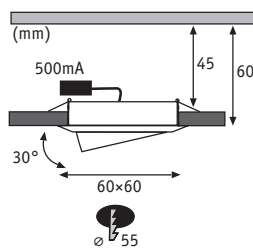

Premium Drilled Alu

Aluminium Aluminium Alluminio

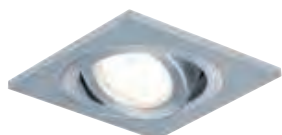

Turned aluminium Aluminium torneado Alluminio tornito

incl. 3x4 W &lt; A++-A

3x500 lm, 2.700 K

30°

230 V, incl. 16 VA

EAN 4000870 929186

929.18 new

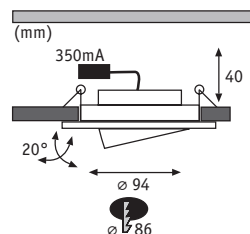

Premium Line LED Aria round

Aluminium Aluminium Alluminio



Brushed aluminium Aluminium mateado Alluminio spazzolato

incl. 3x3 W &lt; A++-A

3x165 lm, 3.000 K

30°, 720 cd

230 V, incl. 10 VA

EAN 4000870 925300

925.30

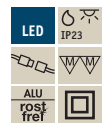
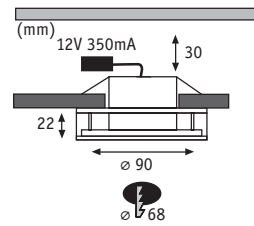

**Premium Line Liro LED round**

Aluminium/Acrylic Aluminio/Acrílico Alluminio/Acrilico



Brushed aluminium/Clear Aluminio mateado/Transparente Alluminio spazzolato/Trasparente

**incl. 3×3 W** < A++-A

3×150 lm, 3.000 K  
 ∠ 45°, 320 cd  
 230 V, incl. 12 VA  
 EAN 4000870 925416  
**925.41**

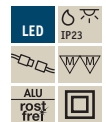
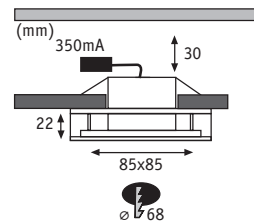

**Premium Line Liro LED square**

Aluminium/Acrylic Aluminio/Acrílico Alluminio/Acrilico



Brushed aluminium/Clear Aluminio mateado/Transparente Alluminio spazzolato/Trasparente

**incl. 3×3 W** < A++-A

3.000 K  
 ∠ 45°, 350 cd  
 230 V, incl. 10 VA  
 EAN 4000870 925393  
**925.39**

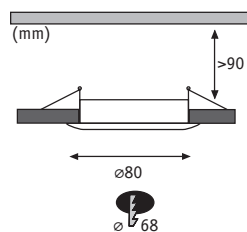

GU10  
 282.06 7W  
 283.45 7W  
 LED □= 414-452

Premium Drilled Alu

Aluminium Aluminium Alluminio



Turned aluminium Aluminium torneado Alluminio tornito

max. 40W

A++-E

incl. 3x7 W, A+

A++-E

230 V

EAN 4000870 926284

926.28

3x460 lm, 2.700 K

230 V

EAN 4000870 929216

929.21 new

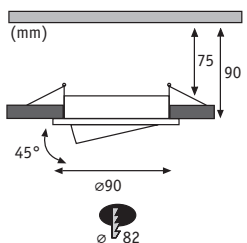

GU10  
 282.06 7W  
 283.45 7W  
 LED □= 414-452

Premium Drilled Alu

Aluminium Aluminium Alluminio



Turned aluminium Aluminium torneado Alluminio tornito

max. 40W

A++-E

incl. 3x7 W, A+

A++-E

230 V

EAN 4000870 926253

926.25

3x460 lm, 2.700 K

230 V

EAN 4000870 929209

929.20 new

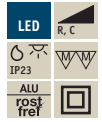
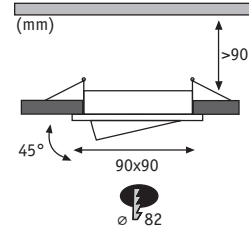

GU10  
 282.06 7W  
 283.45 7W  
 LED □= 414-452

Premium Drilled Alu

Aluminium Aluminium Alluminio



Turned aluminium Aluminium torneado Alluminio tornito

max. 40W

A++-E

incl. 3x7 W, A+

A++-E

230 V

EAN 4000870 926215

926.21

3x460 lm, 2.700 K

230V

EAN 4000870 929193

929.19 new

000

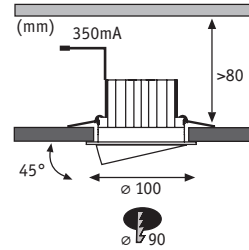

Premium Line Plainly

Aluminium Aluminium Alluminio



Turned aluminium Aluminium torneado Alluminio tornito

incl. 3x7 W

A++-A

3x400 lm, 2.700 K

230 V, incl. 24,5 VA

EAN 4000870 926734

926.73

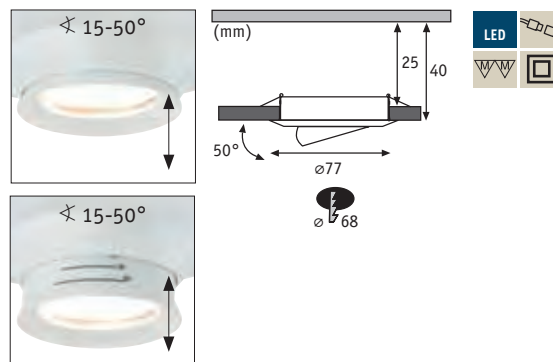

**Premium Line LED Focus**

Aluminium Aluminium Alluminio



Matt white Blanco mate Bianco opaco

**incl. 3x3,8 W** <A++-A

3x680 lm, 2.700 K  
 15°-50°  
 230 V, incl. 12 VA  
 EAN 4000870 935781  
**935.78**



Brushed aluminium Aluminio mateado Alluminio spazzolato

**incl. 3x3,8 W** <A++-A

3x680 lm, 2.700 K  
 15°-50°  
 230 V, incl. 12 VA  
 EAN 4000870 935798  
**935.79**

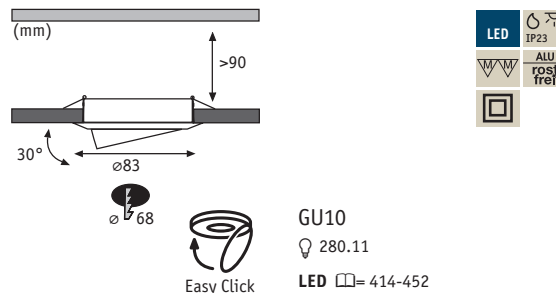

**Premium Line LED 230V GU10 51mm**

Aluminium zinc Aluminium cinc Alluminio zincato



White Blanco Bianco

**incl. 3x1 W, A++** <A++-E

3x35 lm, 6.500 K  
 230 V  
 EAN 4000870 987629  
**987.62**



Brushed iron Hierro mateado Ferro spazzolato

**incl. 3x1 W, A++** <A++-E

3x35 lm, 6.500 K  
 230 V  
 EAN 4000870 987643  
**987.64**



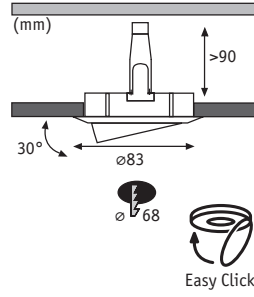

GU10  
 ⚡ 281.44  
 LED □= 414-452

**Premium Line Power LED 230V GU10 51mm** □ Aluminium zinc Aluminio cinc Alluminio zincato



🌀 White Blanco Bianco

**incl. 3×4 W, A+** < A+-E

3×200 lm, 3.000 K  
 230 V  
 EAN 4000870 925348  
**925.34**



🌀 Brushed iron Hierro mateado Ferro spazzolato

**incl. 3×4 W, A+** < A+-E

3×200 lm, 3.000 K  
 230 V  
 EAN 4000870 925331  
**925.33**

000

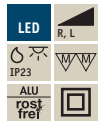
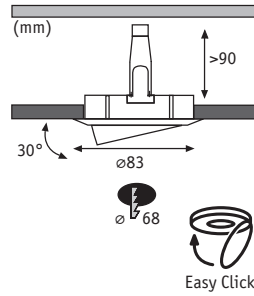

GU10  
 ⚡ 283.45  
 LED □= 414-452

**Premium Line Power LED 230V GU10 51mm** □ Aluminium zinc Aluminio cinc Alluminio zincato



🌀 White Blanco Bianco

**incl. 3×8 W, A+** < A+-E

3×430 lm, 2.700 K  
 230 V  
 EAN 4000870 927137  
**927.13**



🌀 Brushed iron Hierro mateado Ferro spazzolato

**incl. 3×8 W, A+** < A+-E

3×430 lm, 2.700 K  
 230 V  
 EAN 4000870 927090  
**927.09**

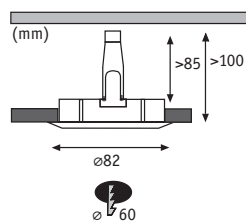

GU10  
 ⚡ 283.00  
 284.10  
 LED □= 414-452

LED 230V GU10 51mm

☒ Metal Metal Metallo



🔗 White Blanco Bianco

**incl. 1×4,5 W, A<sup>++</sup>** < A<sup>++</sup>-E

340 lm, 2.700 K

230 V

EAN 4000870 936580

**936.58** 📦 **new**

**incl. 3×4,5 W, A<sup>++</sup>** < A<sup>++</sup>-E

3×340 lm, 2.700 K

230 V

EAN 4000870 936559

**936.55** **new**



🔗 Brushed iron Hierro mateado Ferro spazzolato

**incl. 1×4,5 W, A<sup>++</sup>** < A<sup>++</sup>-E

340 lm, 2.700 K

230 V

EAN 4000870 936597

**936.59** 📦 **new**

**incl. 3×4,5 W, A<sup>++</sup>** < A<sup>++</sup>-E

3×340 lm, 2.700 K

230 V

EAN 4000870 936566

**936.56** **new**



🔗 Chrome Cromo Cromo

**incl. 1×4,5 W, A<sup>++</sup>** < A<sup>++</sup>-E

340 lm, 2.700 K

230 V

EAN 4000870 936603

**936.60** 📦 **new**

**incl. 3×4,5 W, A<sup>++</sup>** < A<sup>++</sup>-E

3×340 lm, 2.700 K

230 V

EAN 4000870 936573

**936.57** **new**



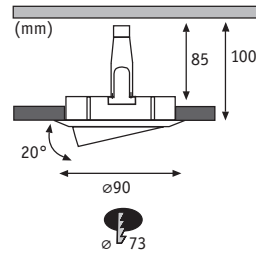

GU10  
 283.00  
 284.10  
 LED □ = 414-452

LED 230V GU10 51mm

☒ Metal Metal Metallo



☞ Matt white Blanco mate Bianco opaco

**incl. 1x4,5 W, A+ A++-E**

340 lm, 2.700 K  
 230 V  
 EAN 4000870 938485

**938.48 new**

**incl. 3x4,5 W, A+ A++-E**

3x340 lm, 2.700 K  
 230 V  
 EAN 4000870 938454

**938.45 new**



☞ Brushed iron Hierro mateado Ferro spazzolato

**incl. 1x4,5 W, A+ A++-E**

340 lm, 2.700 K  
 230 V  
 EAN 4000870 938492

**938.49 new**

**incl. 3x4,5 W, A+ A++-E**

3x340 lm, 2.700 K  
 230 V  
 EAN 4000870 938461

**938.46 new**



☞ Chrome Cromo Cromo

**incl. 1x4,5 W, A+ A++-E**

340 lm, 2.700 K  
 230 V  
 EAN 4000870 938508

**938.50 new**

**incl. 3x4,5 W, A+ A++-E**

3x340 lm, 2.700 K  
 230 V  
 EAN 4000870 938478

**938.47 new**

000

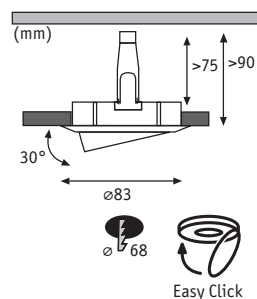

GU10  
 ⚡ 283.00  
 LED □ = 414-452

LED 230V GU10 51mm

☒ Metal Metal Metallo



☞ Matt white Blanco mate Bianco opaco

**incl. 3×6,5 W, A++** < A++-E

3×425 lm, 2.700 K

230 V

EAN 4000870 921050

**921.05 new**



☞ Brushed iron Hierro mateado Ferro spazzolato

**incl. 3×6,5 W, A++** < A++-E

3×425 lm, 2.700 K

230 V

EAN 4000870 921029

**921.02 new**



☞ Chrome Cromo Cromo

**incl. 3×6,5 W, A++** < A++-E

3×425 lm, 2.700 K

230 V

EAN 4000870 921012

**921.01 new**

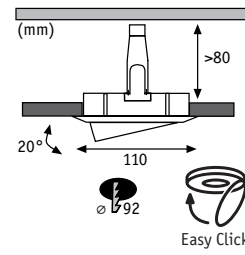

GU10  
 280.48  
 LED □= 414-452

Quality Line LED 230V GU10 51mm

☒ Metal Metal Metallo

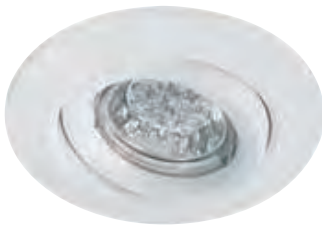

☞ White Blanco Bianco

incl. 1x1 W, A+ < A++-E

35 lm, 3.000 K  
 230 V  
 EAN 4000870 920152  
**920.15** ➡



☞ Brushed iron Hierro mateado Ferro spazzolato

incl. 1x1 W, A+ < A++-E

35 lm, 3.000 K  
 230 V  
 EAN 4000870 920169  
**920.16** ➡



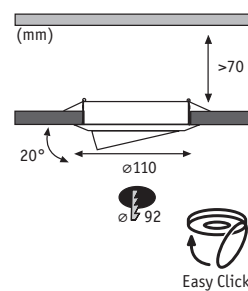

GU10  
 282.99  
 LED □= 414-452

Quality Line LED 230V GU10 51mm

☒ Metal Metal Metallo

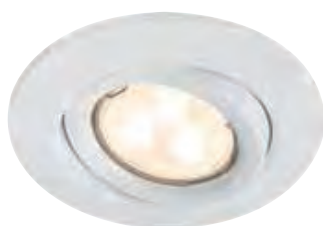

🌀 White Blanco Bianco

**incl. 3×3,5 W, A++** <A++-E

3×230 lm, 2.700 K

230 V

EAN 4000870 920275

**920.27**



🌀 Brushed iron Hierro mateado Ferro spazzolato

**incl. 3×3,5 W, A++** <A++-E

3×230 lm, 2.700 K

230 V

EAN 4000870 920268

**920.26**





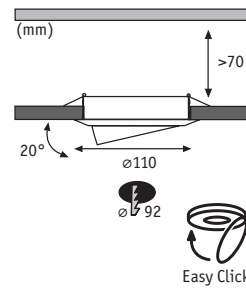

GU10  
 283.00  
 LED □= 414-452

**Quality Line LED 230V GU10 51mm** Metal Metal Metallo

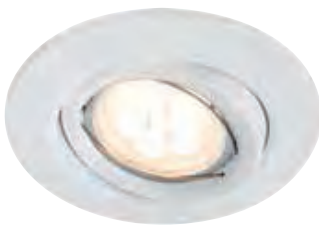

White Blanco Bianco

**incl. 3×6,5 W, A++ A++-E**  
 3×425 lm, 2.700 K  
 230 V  
 EAN 4000870 920299  
**920.29**



Brushed iron Hierro mateado Ferro spazzolato

**incl. 3×6,5 W, A++ A++-E**  
 3×425 lm, 2.700 K  
 230 V  
 EAN 4000870 920282  
**920.28**

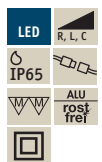
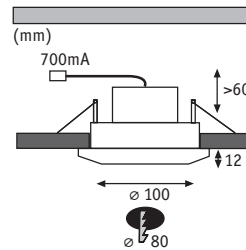

**Premium Line Pearly IP65** Aluminium Aluminium Alluminio



Matt white Blanco mate Bianco opaco

**incl. 3×7,5 W A++-A**  
 3×420 lm, 2.700 K  
 < 25°  
 230 V, incl. 27 VA  
 EAN 4000870 926864  
**926.86**

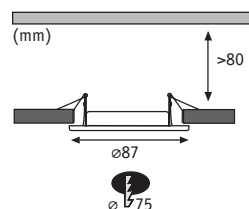

GU5,3  
 832.44  
 832.45  
 LED □= 414-452  
 12V □= 459-462

### Premium Line IP65

Aluminium zinc Aluminium zinc Alluminio zincato

- ▶ Protected from spray water and water jets (IP65)
- ▶ Glare-free due to recessed lamp
- ▶ Protección contra chorros de agua y agua proyectada (IP65)
- ▶ No deslumbra gracias a la luminaria dispuesta más atrás
- ▶ Protezione da spruzzi e getti d'acqua (IP65)
- ▶ Anabagliante grazie a lampadina in posizione arretrata



White Blanco Bianco

max. 35 W < A++-E

12 V  
 EAN 4000870 993330  
 993.33



Brushed iron Hierro mateado Ferro spazzolato

max. 35 W < A++-E

12 V  
 EAN 4000870 993439  
 993.43



Chrome Cromo Cromo

max. 35 W < A++-E

12 V  
 EAN 4000870 993422  
 993.42

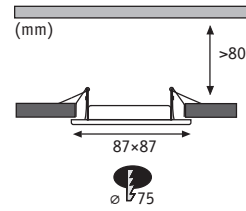

GU5,3

832.44  
832.45

LED □= 414-452

12V □= 459-462

**Premium Line IP65 Quadro**

Aluminium zinc Aluminium cinc Alluminio zincato

- ▶ Protected from spray water and water jets (IP65)
- ▶ Glare-free due to recessed lamp
- ▶ Protección contra chorros de agua y agua proyectada (IP65)
- ▶ No deslumbra gracias a la luminaria dispuesta más atrás
- ▶ Protezione da spruzzi e getti d'acqua (IP65)
- ▶ Anabagliante grazie a lampadina in posizione arretrata



White Blanco Bianco

**max. 35 W** < A++-E

12 V  
EAN 4000870 937280  
**937.28**



Brushed iron Hierro mateado Ferro spazzolato

**max. 35 W** < A++-E

12 V  
EAN 4000870 937266  
**937.26**

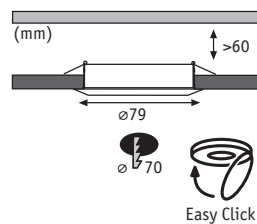

GU5,3

832.44

832.45

832.46

800.47

LED □= 414-452

12V □= 459-462

Premium Line Halogen IP44 12V GU5,3 51mm □ Aluminium zinc Aluminio cinc Alluminio zincato



White Blanco Bianco

max. 50 W

A++-E

12 V

EAN 4000870 179437

179.43



Brushed iron Hierro mateado Ferro spazzolato

max. 50 W

A++-E

12 V

EAN 4000870 179451

179.45



Chrome Cromo Cromo

max. 50 W

A++-E

12 V

EAN 4000870 179468

179.46

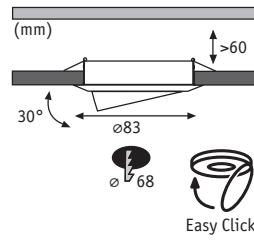

GU5,3

800.47  
832.44  
832.45  
832.46

LED □= 414-452

12V □= 459-462

**Premium Line Halogen 12V GU5,3 51mm**

Aluminium zinc Aluminium zinc Alluminio zincato



White Blanco Bianco

max. 50 W < A++-E

12 V  
EAN 4000870 179536  
179.53



Chrome matt Cromo mate Cromo opaco

max. 50 W < A++-E

12 V  
EAN 4000870 179543  
179.54

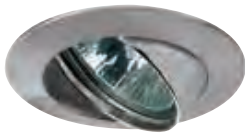

Brushed iron Hierro mateado Ferro spazzolato

max. 50 W < A++-E

12 V  
EAN 4000870 179550  
179.55



Chrome Cromo Cromo

max. 50 W < A++-E

12 V  
EAN 4000870 179567  
179.56



Black Negro Nero

max. 50 W < A++-E

12 V  
EAN 4000870 179512  
179.51

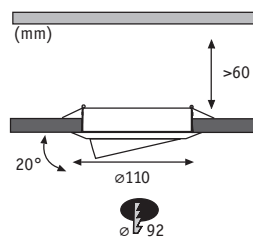

GU5,3

832.44  
832.45  
832.46

LED □= 414-452

12V □= 459-462

Quality Line 12V GU5,3 51mm

Metal Metal Metallo

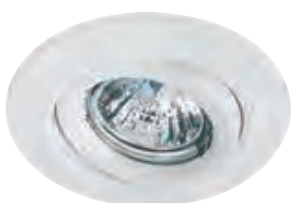

White Bianco Bianco

max. 50 W &lt; A++-E

12 V  
EAN 4000870 989715  
989.71



Brushed iron Hierro mateado Ferro spazzolato

max. 50 W &lt; A++-E

12 V  
EAN 4000870 989685  
989.68

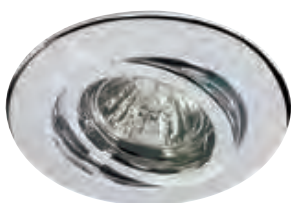

Chrome Cromo Cromo

max. 50 W &lt; A++-E

12 V  
EAN 4000870 989708  
989.70

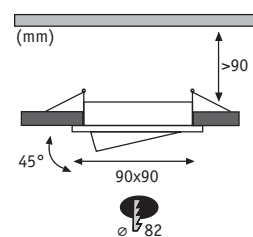

GX5,3

800.47  
800.49  
832.44  
832.45

LED □= 414-452

12V □= 459-462

Premium Line Drilled Alu

Aluminium Aluminium Alluminio



Brushed aluminium Aluminio mateado Alluminio spazzolato

max. 40 W &lt; A++-E

12 V  
EAN 4000870 926208  
926.20



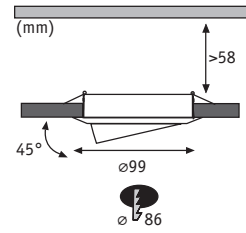

GU5,3

800.47  
832.44  
832.45  
832.46

LED □ = 414-452

12V □ = 459-462

**Premium Line Halogen 12V GU5,3 51mm**    Aluminium Aluminium Alluminio

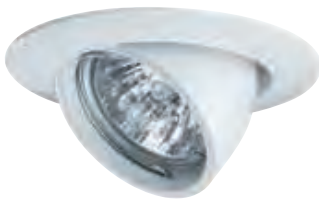

White Blanco Bianco

**max. 50W**    A++-E

12V  
EAN 4000870 987735  
**987.73**

000

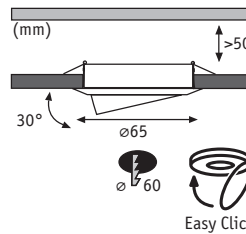

GU4

832.47  
832.48

LED □ = 414-452

12V □ = 459-462

**Premium Line Halogen 12V GU4 35mm**    Aluminium zinc Aluminium cinc Alluminio zincato



White Blanco Bianco

**max. 35W**    A++-E

12V  
EAN 4000870 057742  
**5774**



Brushed iron Hierro mateado Ferro spazzolato

**max. 35W**    A++-E

12V  
EAN 4000870 057759  
**5775**

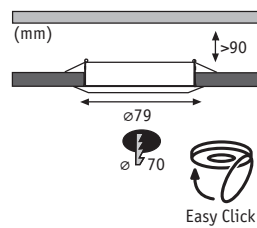

GU10  
 800.35  
 800.36  
 836.35  
**LED** □= 414-452

**Premium Line Halogen IP44 230V GU10 51mm** □ Aluminium zinc Aluminio cinc Alluminio zincato



White Blanco Bianco

**max. 50 W** < A++-E

230 V  
 EAN 4000870 057926  
**5792** □



Brushed iron Hierro mateado Ferro spazzolato

**max. 50 W** < A++-E

230 V  
 EAN 4000870 057964  
**5796** □



Chrome Cromo Cromo

**max. 50 W** < A++-E

230 V  
 EAN 4000870 057940  
**5794** □



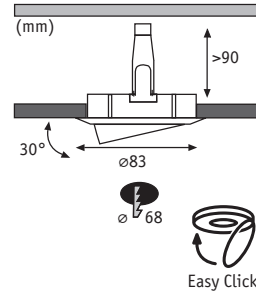

GU10  
800.35  
800.36  
836.35  
LED □= 414-452

**Premium Line Halogen 230V GU10 51mm**    Aluminium zinc    Aluminio cinc    Alluminio zincato



White Blanco Bianco

**max. 50 W**    A++-E

230 V  
EAN 4000870 989401  
**989.40**



Brushed iron Hierro mateado Ferro spazzolato

**max. 50 W**    A++-E

230 V  
EAN 4000870 988787  
**988.78**



Chrome Cromo Cromo

**max. 50 W**    A++-E

230 V  
EAN 4000870 989432  
**989.43**

000

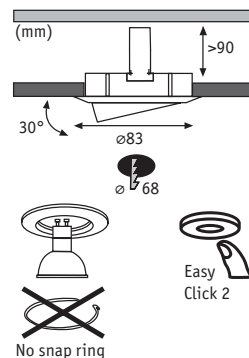

GU10  
 800.35  
 800.36  
 836.35  
**LED** □= 414-452

Easy Click 2

No snap ring

**Premium Line easyClick2**

Aluminium zinc / Aluminio cinc / Alluminio zincato

- ▶ No snap ring necessary
- ▶ Bulb exchange simply by pressing on the bulb
- ▶ Sin necesidad de circlip
- ▶ Luminaria fácil de cambiar presionando sencillamente sobre ella
- ▶ Anello di arresto non necessario
- ▶ Sostituzione semplice della lampadina premendo su di essa

White / Blanco / Bianco

Brushed iron / Hierro mateado / Ferro spazzolato



**max. 50 W** <math>A^{++}-E</math>  
 230 V  
 EAN 4000870 937310  
**937.31**



**max. 50 W** <math>A^{++}-E</math>  
 230 V  
 EAN 4000870 937303  
**937.30**



GU10  
 282.06  
 283.45  
**LED** □= 414-452

**Premium Cardano GU10 dimmable**

Metal / Metal / Metallo



Titanium / Titanio / Titanio  
**incl. 1x7 W, <math>A^{++}</math>** <math>A^{++}-E</math>  
 460 lm, 2.700 K  
 230 V  
 EAN 4000870 929056  
**929.05 new**

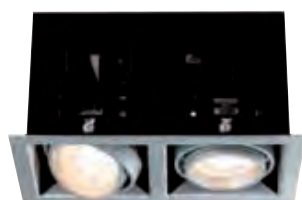
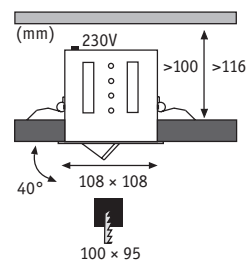

Titanium / Titanio / Titanio  
**incl. 2x7 W, <math>A^{++}</math>** <math>A^{++}-E</math>  
 2x460 lm, 2.700 K  
 230 V  
 EAN 4000870 929063  
**929.06 new**

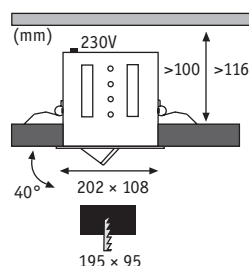



**Star Frill LED**

Plastic/Aluminium Plástico/Aluminio Plastica/Alluminio

- ▶ Effect and decorative light
- ▶ Ideal for wall and / or ceiling decorations
- ▶ Easy to install on plaster or wallpaper, using a ribbon cable
- ▶ Luz de efectos y decorativa
- ▶ Ideal para decorar paredes o techos
- ▶ Instalación fácil mediante un cable de cinta plana sobre el enlucido o el papel pintado
- ▶ Di grande effetto e suggestivo
- ▶ Ideali come decorazione da parete e/o soffitto
- ▶ Semplici da posare, tramite cavo piatto su intonaco o tappezzeria



Matt white/Chrome Blanco mate/Cromo Bianco opaco/Cromo

**incl. 6x0,45 W** <math>A^{++}</math>-A  
 6x28 lm, 2.700 K  
 <math>\angle 100^\circ</math>  
 230/12 V, incl. <math>\approx 7</math> VA  
 EAN 4000870 936481  
**936.48 new**

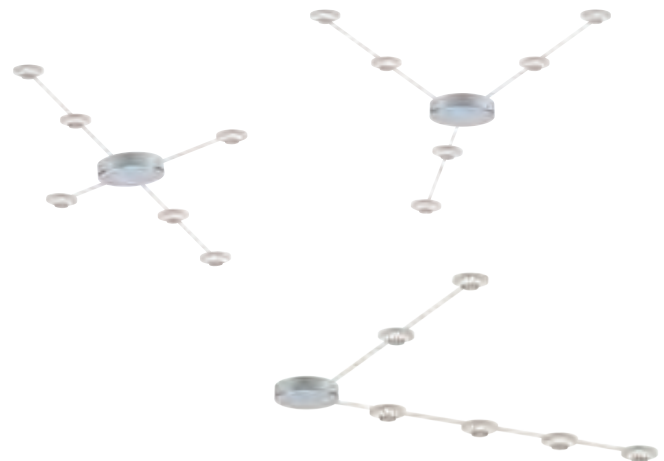

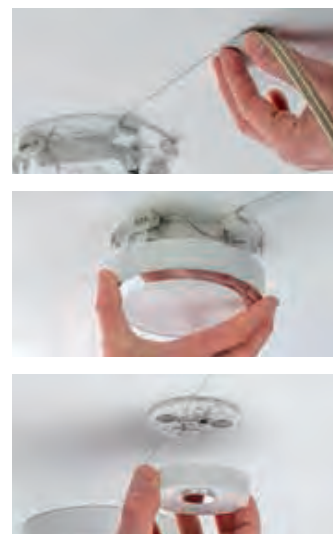
**Star Basin LED**

Plastic/Metal Plástico/Metal Plastica/Metallo

- ▶ Effect and decorative light
- ▶ Ideal for wall and / or ceiling decorations
- ▶ Easy to install on plaster or wallpaper, using a ribbon cable
- ▶ Luz de efectos y decorativa
- ▶ Ideal para decorar paredes o techos
- ▶ Instalación fácil mediante un cable de cinta plana sobre el enlucido o el papel pintado
- ▶ Di grande effetto e suggestivo
- ▶ Ideali come decorazione da parete e/o soffitto
- ▶ Semplici da posare, tramite cavo piatto su intonaco o tappezzeria

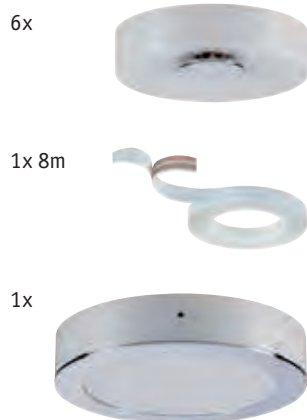

Matt white/Chrome Blanco mate/Cromo Bianco opaco/Cromo

**incl. 6x0,45 W** < A++-A

6x28 lm, 2.700 K  
 ∠ 145°  
 230/12 V, incl. 7 VA  
 EAN 4000870 936474

**936.47 new**





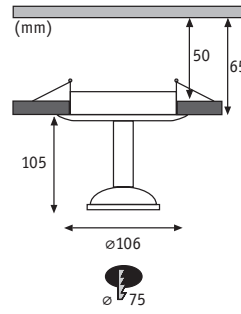

not. incl.  
Remote Control  
□= 388



**Star Glint RGB BLE**

Plastic Plástico Plastica



Matt white Blanco mate Bianco opaco

incl. 1x2,5 W < A++-A

58 lm  
 40°  
 230/12 V, incl. 4 VA  
 EAN 4000870 935927  
**935.92 new**



000

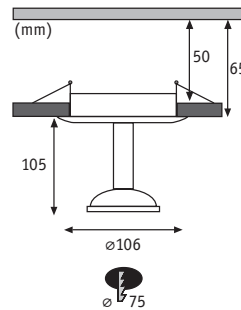

**Star Glint LED**

Plastic Plástico Plastica



Matt white Blanco mate Bianco opaco

incl. 1x2,5 W < A++-A

150 lm, 2.700 K  
 30°  
 230/12 V, incl. 4 VA  
 EAN 4000870 935910  
**935.91 new**

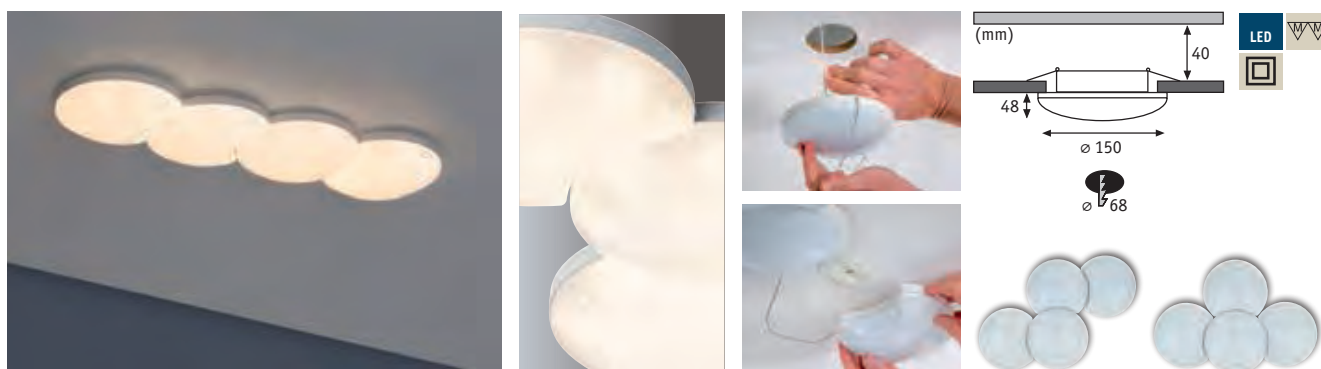

Star Rolling LED 230V/12V

☒ Metal/Acrylic Metal/Acrílico Metallo/Acricico



🕒 White Blanco Bianco

**incl. 1x (4x3 W)** <math>A^{++}</math>-A

1x 4x278 lm, 2.700 K

230/12V, incl. ⚡ 12 VA

EAN 4000870 935903

**935.90 new**

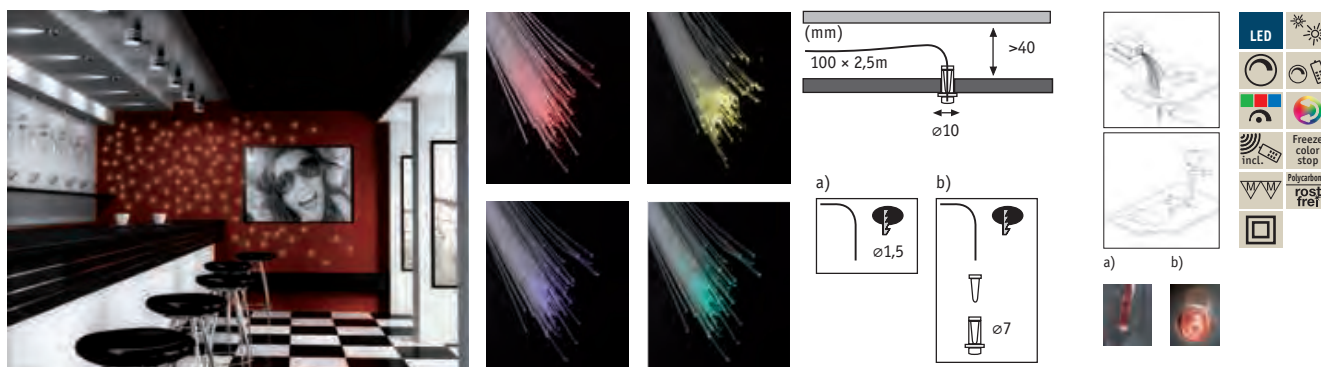

SkyLight RGB

☒ Polycarbonate Policarbonato Policarbonato

- ▶ Light fibre set with IR remote control:
- ▶ 100 light fibres.
- ▶ 5 speeds, 6 brightness settings, 4 RGB functions, 7 colours

- ▶ Kit de fibra óptica con mando a distancia por infrarrojos:
- ▶ 100 fibras.
- ▶ 5 velocidades, 6 niveles de claridad, 4 funciones RGB, 7 colores

- ▶ Set di fibre luminose con telecomando a infrarossi:
- ▶ 100 fibre ottiche.
- ▶ 5 velocità, 6 livelli di luminosità, 4 funzioni RGB, 7 colori



🕒 Multicolour Multicolor Multicolore

**incl. 1x3 W**

230V, incl. ⚡ 3 VA

EAN 4000870 922095

**922.09**

- 11x Color
- 7x Color step by step
- 7x Color by puls
- 7x Color dim change
- 7x Color change
- 6x dimable

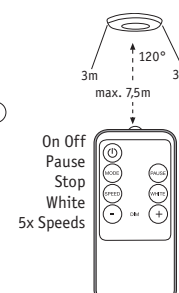

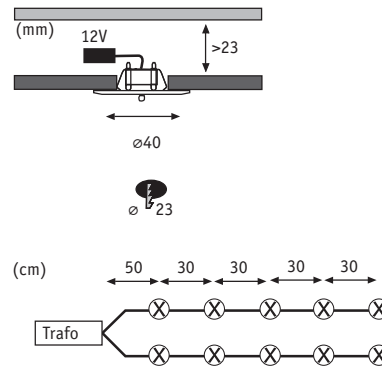

**Star Line LED**

☒ Metal Metal Metallo



🔗 Chrome Cromo Cromo

**incl. 10×0,25 W** < A++-A

3.000 K

230/12V, incl. ⚡ 7 VA

EAN 4000870 998106

**998.10**

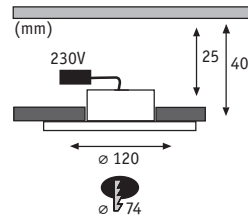

**Premium Whirl 120mm dimmable**

☒ Aluminium/Acrylic Aluminio/Acrílico Alluminio/Acrilico



🔗 Turned aluminium/Satin Aluminio torneado/Satinado Alluminio tornito/Satinato

**incl. 3×5,5 W** < A++-A

3×460 lm, 3.000 K

⚡ 110°

230 V

EAN 4000870 929070

**929.07 new**

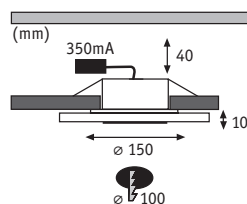

### Premium Line Whirl LED

Aluminium/Acrylic Alumínio/Acrílico Alluminio/Acrílico



Turned aluminium/Satin Alumínio torneado/Satinado Alluminio tornito/Satinato

**incl. 1×6 W**

A<sup>++</sup>-A

450 lm, 3.000 K  
230 V, incl. 6 VA  
EAN 4000870 925355  
**925.35**

**incl. 3×6 W**

A<sup>++</sup>-A

3×450 lm, 3.000 K  
∠ 113°  
230 V, incl. 23 VA  
EAN 4000870 925430  
**925.43**

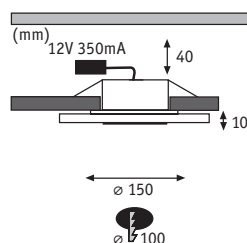

### Premium Line Whirl dimmable LED

Aluminium/Acrylic Alumínio/Acrílico Alluminio/Acrílico



Turned aluminium/Satin Alumínio torneado/Satinado Alluminio tornito/Satinato

**incl. 1×6 W**

A<sup>++</sup>-A

480 lm, 3.000 K  
∠ 110°  
230 V, incl. 9 VA  
EAN 4000870 927359  
**927.35**

**incl. 3×6 W**

A<sup>++</sup>-A

3×450 lm, 3.000 K  
∠ 110°  
230 V, incl. 18 VA  
EAN 4000870 929179  
**929.17 new**

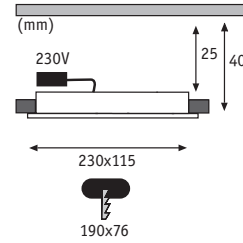

**Premium Whirl oval dimmable**

Aluminium/Acrylic Aluminio/Acrílico Alluminio/Acrílico



Turned aluminium/Satin Aluminio torneado/Satinado Alluminio tornito/Satinato

**incl. 1x8 W** < A++-A

680 lm, 3.000 K

110°

230 V

EAN 4000870 929087

**929.08 new**

000

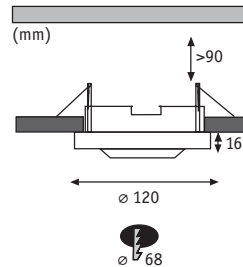

GU10

282.86

LED □= 414-452

**Premium EBL Single Shell**

Aluminium/Glass Aluminio/Cristal Alluminio/Vetro

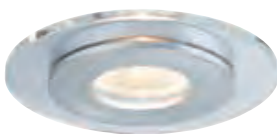

Brushed aluminium/Clear Aluminio mateado/Transparente Alluminio spazzolato/Trasparente

**incl. 3x3,5 W**, < A++ < A++-E

3x250 lm, 2.700 K

230 V

EAN 4000870 927267

**927.26**

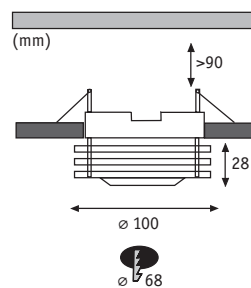

GU10  
 ⚡ 282.86  
 LED □ = 414-452

### Premium EBL Shell

Aluminium/Glass Aluminium/Cristal Alluminio/Vetro



Brushed aluminium Aluminium mateado Alluminio spazzolato

incl. 3×3,5 W, A++ A++-E

3×250 lm, 2.700 K

230 V

EAN 4000870 927281

927.28

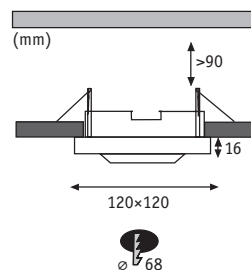

GU10  
 ⚡ 282.86  
 LED □ = 414-452

### Premium EBL Single Layer

Aluminium/Glass Aluminium/Cristal Alluminio/Vetro



Brushed aluminium/Clear Aluminium mateado/Transparente Alluminio spazzolato/Trasparente

incl. 3×3,5 W, A++ A++-E

3×250 lm, 2.700 K

230 V

EAN 4000870 927274

927.27



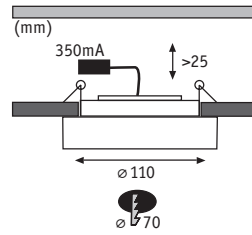

**Premium Line Bagel**

Acrylic/Aluminium Acrílico/Aluminio Acrílico/Alluminio



Satin/Aluminium Satinado/Aluminio Satinado/Alluminio

**incl. 3x5,5 W** <math>A^{++}-A</math>

3x420 lm, 2.700 K

$\sphericalangle$  127°

230 V, incl.  $\text{⚡}$  18 VA

EAN 4000870 927045

**927.04**

000

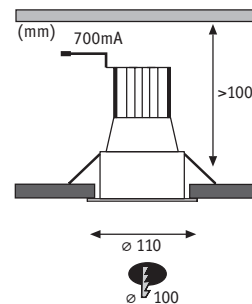

**Premium Line Daz LED**

Metal Metal Metallo

► Improved lighting comfort with glare-free recessed lighting providing general and indirect room lighting.

► Confort luminoso mejorado mediante lámparas empotrables que no deslumbran y en iluminación directa de interiores

► Migliore comfort luminoso grazie a faretti ad incasso senza effetto abbagliante per l'illuminazione base e l'illuminazione indiretta di interni

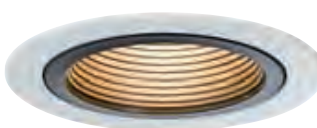

White/Black Blanco/Negro Bianco/Nero

**incl. 3x5,6 W** <math>A^{++}-A</math>

3x460 lm, 2.700 K

$\sphericalangle$  23°

230 V, incl.  $\text{⚡}$  30 VA

EAN 4000870 927021

**927.02**

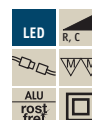
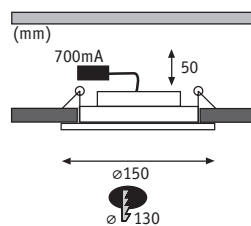
**Premium Line Dot**

Aluminium/Glass Aluminio/Cristal Alluminio/Vetro



Brushed aluminium Aluminio mateado Alluminio spazzolato

**incl. 3x8 W** <A++-A

3x520 lm, 2.700 K

∠ 98°

230 V, incl. 36 VA

EAN 4000870 926949

**926.94**

White/Chrome Blanco/Cromo Bianco/Cromo

**incl. 3x8 W** <A++-A

3x520 lm, 2.700 K

∠ 98°

230 V, incl. 36 VA

EAN 4000870 926932

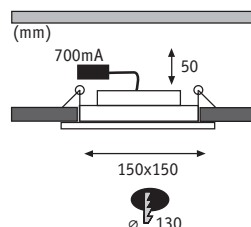
**926.93****Premium Line Dice**

Aluminium/Glass Aluminio/Cristal Alluminio/Vetro



Brushed aluminium Aluminio mateado Alluminio spazzolato

**incl. 3x8 W** <A++-A

3x520 lm, 2.700 K

∠ 98°

230 V, incl. 36 VA

EAN 4000870 926963

**926.96**

White/Chrome Blanco/Cromo Bianco/Cromo

**incl. 3x8 W** <A++-A

3x520 lm, 2.700 K

∠ 98°

230 V, incl. 36 VA

EAN 4000870 926956

**926.95**

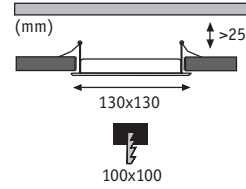

**Premium Line Panel**

☒ Metal/Glass Metal/Cristal Metallo/Vetro

- ▶ Blue light effect can be switched on with the normal light switch
- ▶ Efecto de luz azul aplicable con interruptor de luz normal
- ▶ Effetto luce blu attivabile con normale interruttore della luce



🔗 White/Clear Blanco/Transparente Bianco/Trasparente

**incl. 2x7 W** < A++-A  
 2x255 lm, 2.700 K  
 230/12 V, incl. ⚡ 15 VA  
 EAN 4000870 927106  
**927.10**

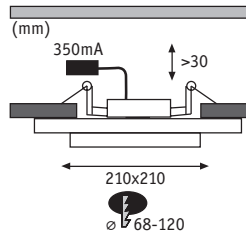

**Premium Line Panel Jet**

☒ Aluminium/Plastic Aluminio/Plástico Alluminio/Plastica



🔗 Brushed iron Hierro mateado Ferro spazzolato

**incl. 1x11,5 W** < A++-A  
 840 lm, 2.700 K  
 230 V  
 EAN 4000870 927892  
**927.89**

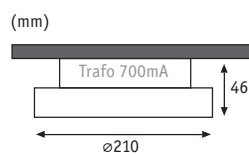

### Premium Line Panel Shower

Aluminium/Plastic Aluminio/Plástico Alluminio/Plastica



Chrome matt Cromo mate Cromo opaco

incl. 1x10 W < A++-A

620 lm, 2.700 K

∠ 120°

230 V

EAN 4000870 927908

**927.90**

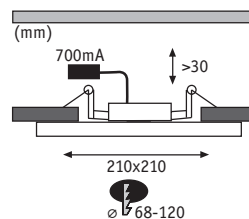

### Premium Line Panel Shower

Aluminium/Plastic Aluminio/Plástico Alluminio/Plastica



Chrome matt Cromo mate Cromo opaco

incl. 1x10 W < A++-A

620 lm, 2.700 K

∠ 120°

230 V

EAN 4000870 927915

**927.91**

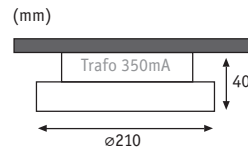

Premium Line Panel Line IP44

Aluminium/Plastic Aluminio/Plástico Alluminio/Plastica



Matt white Blanco mate Bianco opaco

incl. 1x11,5 W < A++-A

630 lm, 2.700 K

230 V

EAN 4000870 927922

927.92

000

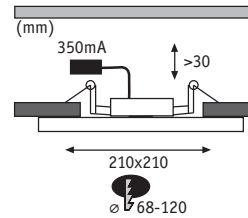

Premium Line Panel Line IP44

Aluminium/Plastic Aluminio/Plástico Alluminio/Plastica



Matt white Blanco mate Bianco opaco

incl. 1x11,5 W < A++-A

680 lm, 2.700 K

230 V

EAN 4000870 927939

927.93

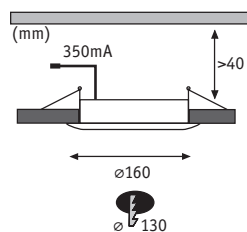

### Premium Line DecoDot

☒ Glass/Metal Cristal/Metal Vetro/Metallo



☞ Clear/White Transparente/Blanco Trasparente/Bianco

**incl. 1×7,5 W** <math>A^{++-A}</math>

600 lm, 2.700 K

☞ 110°

230 V, incl. ⚡ 9 VA

EAN 4000870 927335

**927.33**

**incl. 2×7,5 W** <math>A^{++-A}</math>

2×550 lm, 2.700 K

☞ 110°

230 V, incl. ⚡ 18 VA

EAN 4000870 927052

**927.05**

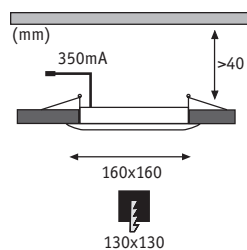

### Premium Line DecoDice

☒ Glass/Metal Cristal/Metal Vetro/Metallo



☞ Clear/White Transparente/Blanco Trasparente/Bianco

**incl. 1×7,5 W** <math>A^{++-A}</math>

640 lm, 2.700 K

☞ 110°

230 V, incl. ⚡ 9 VA

EAN 4000870 927342

**927.34**

**incl. 2×7,5 W** <math>A^{++-A}</math>

2×550 lm, 2.700 K

☞ 110°

230 V, incl. ⚡ 18 VA

EAN 4000870 927069

**927.06**



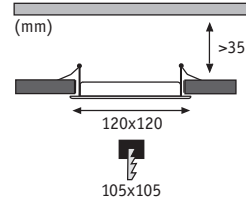

**Premium Line Panel**

Aluminium/Plastic Aluminio/Plástico Alluminio/Plastica



Matt white Blanco mate Bianco opaco

**incl. 1x6,5 W** <A++-A

790 lm, 2.700 K

∠ 120°

230 V, incl. 7 VA

EAN 4000870 920985

**920.98**



Brushed iron Hierro mateado Ferro spazzolato

**incl. 1x6,5 W** <A++-A

790 lm, 2.700 K

∠ 120°

230 V, incl. 7 VA

EAN 4000870 921005

**921.00**

000

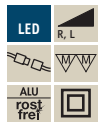
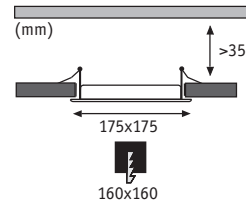

**Premium Line Panel**

Aluminium/Plastic Aluminio/Plástico Alluminio/Plastica



Matt white Blanco mate Bianco opaco

**incl. 1x11 W** <A++-A

1.410 lm, 2.700 K

∠ 120°

230 V, incl. 12 VA

EAN 4000870 920374

**920.37**



Brushed iron Hierro mateado Ferro spazzolato

**incl. 1x11 W** <A++-A

1.410 lm, 2.700 K

∠ 120°

230 V, incl. 12 VA

EAN 4000870 920411

**920.41**

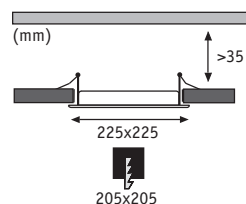

### Premium Line Panel

Aluminium/Plastic Aluminio/Plástico Alluminio/Plastica



Matt white Blanco mate Bianco opaco

**incl. 1x14 W** <math>A^{++}-A</math>

1.790 lm, 2.700 K

$\sphericalangle$  120°

230V, incl. 16 VA

EAN 4000870 920350

**920.35**



Brushed iron Hierro mateado Ferro spazzolato

**incl. 1x14 W** <math>A^{++}-A</math>

1.790 lm, 2.700 K

$\sphericalangle$  120°

230V, incl. 16 VA

EAN 4000870 920398

**920.39**



**Smart Home** ☞ = 386-403

Comfortably control your lighting with your smart phone or remote control, using the additional products from the Smart Home chapter (P. 386-403).

Controle su luz cómodamente mediante el smartphone o el mando a distancia con los productos complementarios del capítulo Smart Home (p. 386-403)

Comandate le vostre luci comodamente utilizzando lo smartphone o il telecomando con i prodotti supplementari del capitolo Smart Home (pag. 386-403).

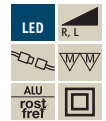
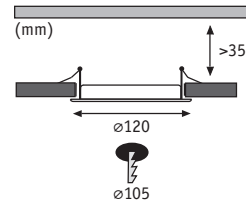

Premium Line Panel

Aluminium/Plastic Aluminio/Plástico Alluminio/Plastica



Matt white Blanco mate Bianco opaco

**incl. 1x6,5 W** <math>\langle A^{++}-A</math>

840 lm, 2.700 K

$\sphericalangle$  120°

230 V, incl.  $\text{---}$  7 VA

EAN 4000870 920978

**920.97**



Brushed iron Hierro mateado Ferro spazzolato

**incl. 1x6,5 W** <math>\langle A^{++}-A</math>

840 lm, 2.700 K

$\sphericalangle$  120°

230 V, incl.  $\text{---}$  7 VA

EAN 4000870 920992

**920.99**

000

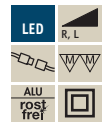
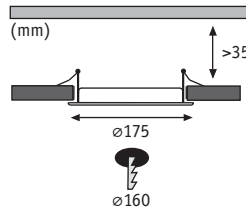

Premium Line Panel

Aluminium/Plastic Aluminio/Plástico Alluminio/Plastica



Matt white Blanco mate Bianco opaco

**incl. 1x11 W** <math>\langle A^{++}-A</math>

1.480 lm, 2.700 K

$\sphericalangle$  120°

230 V, incl.  $\text{---}$  12 VA

EAN 4000870 920367

**920.36**



Brushed iron Hierro mateado Ferro spazzolato

**incl. 1x11 W** <math>\langle A^{++}-A</math>

1.480 lm, 2.700 K

$\sphericalangle$  120°

230 V, incl.  $\text{---}$  12 VA

EAN 4000870 920404

**920.40**

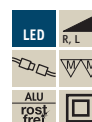
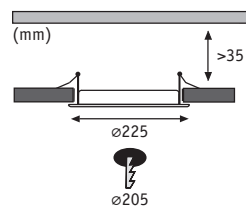

### Premium Line Panel

Aluminium/Plastic Aluminio/Plástico Alluminio/Plastica



Matt white Blanco mate Bianco opaco

**incl. 1x14 W** <math>\langle A^{++}-A</math>

1.880 lm, 2.700 K

<math>\sphericalangle 120^\circ</math>

230 V, incl. <math>\text{---}</math> 16 VA

EAN 4000870 920343

**920.34**



Brushed iron Hierro mateado Ferro spazzolato

**incl. 1x14 W** <math>\langle A^{++}-A</math>

1.880 lm, 2.700 K

<math>\sphericalangle 120^\circ</math>

230 V, incl. <math>\text{---}</math> 16 VA

EAN 4000870 920381

**920.38**



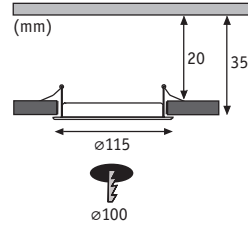

Quality Line Panel IP44

Plastic Plástico Plastica

White Blanco Bianco



**incl. 1x6 W** <A++-A  
589 lm, 2.700 K  
∠ 110°  
230 V  
EAN 4000870 920619  
**920.61**



Chrome matt Cromo mate Cromo opaco

**incl. 1x6 W** <A++-A  
589 lm, 2.700 K  
∠ 110°  
230 V  
EAN 4000870 920732  
**920.73**



**incl. 1x6 W** <A++-A  
671 lm, 4.000 K  
∠ 110°  
230 V  
EAN 4000870 920589  
**920.58**



**incl. 1x6 W** <A++-A  
671 lm, 4.000 K  
∠ 110°  
230 V  
EAN 4000870 920701  
**920.70**

000

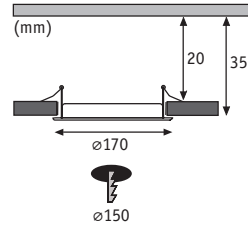

Quality Line Panel IP44

Plastic Plástico Plastica

White Blanco Bianco



**incl. 1x12 W** <A++-A  
1.118 lm, 2.700 K  
∠ 110°  
230 V  
EAN 4000870 920626  
**920.62**



Chrome matt Cromo mate Cromo opaco

**incl. 1x12 W** <A++-A  
1.118 lm, 2.700 K  
∠ 110°  
230 V  
EAN 4000870 920749  
**920.74**



**incl. 1x12 W** <A++-A  
1.262 lm, 4.000 K  
∠ 120°  
230 V  
EAN 4000870 920596  
**920.59**



**incl. 1x12 W** <A++-A  
1.262 lm, 4.000 K  
∠ 120°  
230 V  
EAN 4000870 920718  
**920.71**

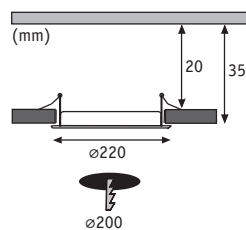

Quality Line Panel IP44

Plastic Plástico Plastica

White Blanco Bianco



incl. 1×18 W A++-A

1.724 lm, 2.700 K

∠ 110°

230 V

EAN 4000870 920633

920.63

Chrome matt Cromo mate Cromo opaco



incl. 1×18 W A++-A

1.724 lm, 2.700 K

∠ 110°

230 V

EAN 4000870 920756

920.75



incl. 1×18 W A++-A

2.011 lm, 4.000 K

∠ 120°

230 V

EAN 4000870 920602

920.60



incl. 1×18 W A++-A

2.011 lm, 4.000 K

∠ 120°

230 V

EAN 4000870 920725

920.72



Smart Home ☎ = 386-403

Comfortably control your lighting with your smart phone or remote control, using the additional products from the Smart Home chapter (P. 386-403).

Controle su luz cómodamente mediante el smartphone o el mando a distancia con los productos complementarios del capítulo Smart Home (p. 386-403)

Comandate le vostre luci comodamente utilizzando lo smartphone o il telecomando con i prodotti supplementari del capitolo Smart Home (pag. 386-403).



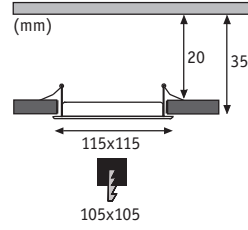

**Quality Line Panel IP44** Plastic Plástico Plastica

White Blanco Bianco



**incl. 1x6 W** A++-A  
 589 lm, 2.700 K  
 ∠ 110°  
 230 V  
 EAN 4000870 920671  
**920.67**



Chrome matt Cromo mate Cromo opaco

**incl. 1x6 W** A++-A  
 589 lm, 2.700 K  
 ∠ 110°  
 230 V  
 EAN 4000870 920794  
**920.79**



**incl. 1x6 W** A++-A  
 671 lm, 4.000 K  
 ∠ 100°  
 230 V  
 EAN 4000870 920640  
**920.64**



**incl. 1x6 W** A++-A  
 671 lm, 4.000 K  
 ∠ 100°  
 230 V  
 EAN 4000870 920763  
**920.76**

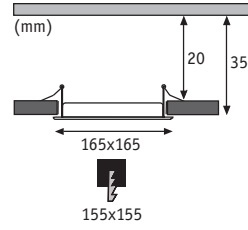

**Quality Line Panel IP44** Plastic Plástico Plastica

White Blanco Bianco



**incl. 1x12 W** A++-A  
 1.119 lm, 2.700 K  
 ∠ 110°  
 230 V  
 EAN 4000870 920688  
**920.68**



Chrome matt Cromo mate Cromo opaco

**incl. 1x12 W** A++-A  
 1.119 lm, 2.700 K  
 ∠ 110°  
 230 V  
 EAN 4000870 920800  
**920.80**



**incl. 1x12 W** A++-A  
 1.263 lm, 4.000 K  
 ∠ 120°  
 230 V  
 EAN 4000870 920657  
**920.65**



**incl. 1x12 W** A++-A  
 1.263 lm, 4.000 K  
 ∠ 120°  
 230 V  
 EAN 4000870 920770  
**920.77**

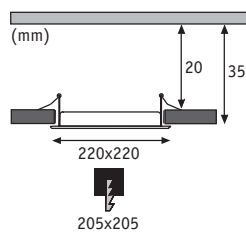

## Quality Line Panel IP44

Plastic Plástico Plastica



White Blanco Bianco

incl. 1x18 W A++-A

1.724 lm, 2.700 K

 $\sphericalangle$  110°

230 V

EAN 4000870 920695

**920.69**

Chrome matt Cromo mate Cromo opaco

incl. 1x18 W A++-A

1.724 lm, 2.700 K

 $\sphericalangle$  110°

230 V

EAN 4000870 920817

**920.81**incl. 1x18 W A++-A

2.011 lm, 4.000 K

 $\sphericalangle$  120°

230 V

EAN 4000870 920664

**920.66**incl. 1x18 W A++-A

2.011 lm, 4.000 K

 $\sphericalangle$  120°

230 V

EAN 4000870 920787

**920.78**



000

### *Downlights | CabinetLight*

Under-cabinet luminaires for optimum illumination of work surfaces in the kitchen, wall cabinets and shelf units etc.

Luminarias para la instalación debajo de armarios para la iluminación óptima, p. ej., de áreas de trabajo en la cocina, armarios empotrados o estanterías.

Lampade sottopensili per illuminazione ottimale, ad es. di aree di lavoro in cucina, pensili o scaffali.

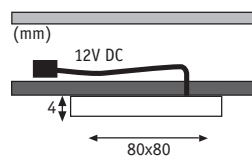

Micro Line LED Leaf

Aluminium Aluminium Alluminio



Brushed aluminium Aluminium mateado Alluminio spazzolato

incl. 3x4,7 W &lt; A++-A

3x310 lm, 2.700 K

∠ 120°

230/12V, incl. ⚡ 15 VA

EAN 4000870 935613

935.61

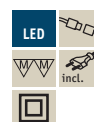
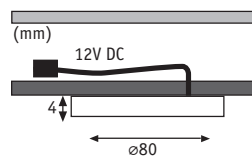

Micro Line LED Leaf

Aluminium Aluminium Alluminio



Brushed aluminium Aluminium mateado Alluminio spazzolato

incl. 3x4 W &lt; A++-A

3x280 lm, 2.700 K

∠ 120°

230/12V, incl. ⚡ 12 VA

EAN 4000870 935620

935.62

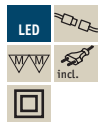
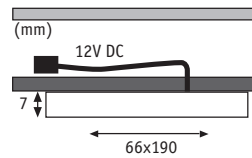

Micro Line LED Pattern

Plastic Plástico Plastica

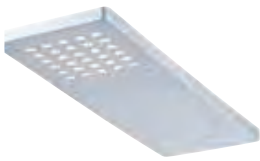

Chrome matt Cromo mate Cromo opaco

**incl. 3x2,2 W** < A++-A

3x160 lm, 2.700 K

70°

230/12 V, incl. 12 VA

EAN 4000870 935637

**935.63**

000

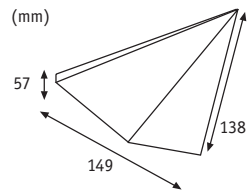

Micro Line LED Kite

Aluminium Aluminio Alluminio



Brushed aluminium Aluminio mateado Alluminio spazzolato

**incl. 1x6,2 W** < A++-A

580 lm, 2.700 K

230/12 V, incl. 8 VA

EAN 4000870 920312

**920.31**

**incl. 2x6,2 W** < A++-A

2x580 lm, 2.700 K

230/12 V, incl. 15 VA

EAN 4000870 935842

**935.84**

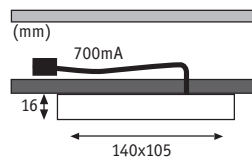

Micro Line LED Vane

Aluminium Aluminium Alluminio

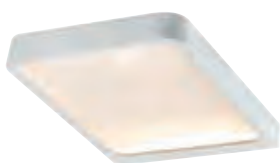

Matt white Blanco mate Bianco opaco

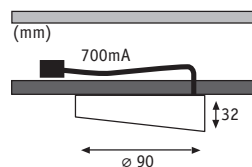
**incl. 1x6,7 W** <A++-A450 lm, 2.700 K  
230/12 V, incl.  $\text{⊕}$  8 VA  
EAN 4000870 920329  
**920.32****incl. 2x6,7 W** <A++-A2x450 lm, 2.700 K  
230/12 V, incl.  $\text{⊕}$  15 VA  
EAN 4000870 935835  
**935.83**

Micro Line LED Gate

Aluminium Aluminium Alluminio



Brushed iron Hierro mateado Ferro spazzolato

**incl. 1x6,2 W** <A++-A620 lm, 2.700 K  
230/12 V, incl.  $\text{⊕}$  8 VA  
EAN 4000870 920336  
**920.33****incl. 2x6,2 W** <A++-A2x620 lm, 2.700 K  
230/12 V, incl.  $\text{⊕}$  15 VA  
EAN 4000870 935828  
**935.82**



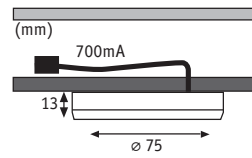

Micro Line LED Unity

☒ Metal/Acrylic Metal/Acrílico Metallo/Acrilico



☞ Brushed iron Hierro mateado Ferro spazzolato

**incl. 3×4,5 W** < A++-A

3×360 lm, 2.700 K

⊘ 120°

230 V, incl. ⚡ 15 VA

EAN 4000870 935644

**935.64**

000

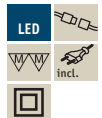
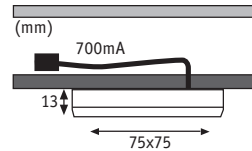

Micro Line LED Unity

☒ Metal/Acrylic Metal/Acrílico Metallo/Acrilico



☞ Brushed iron Hierro mateado Ferro spazzolato

**incl. 3×4,5 W** < A++-A

3×360 lm, 2.700 K

⊘ 120°

230 V, incl. ⚡ 15 VA

EAN 4000870 935651

**935.65**

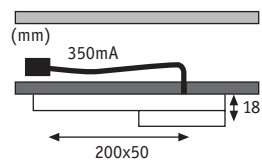

## Micro Line LED Setup

Metal Metal Metallo



Brushed iron Hierro mateado Ferro spazzolato

incl. 3x3,2 W &lt; A++-A

3x220 lm, 2.700 K

∠ 120°

230 V, incl. ⚡ 15 VA

EAN 4000870 935668

935.66

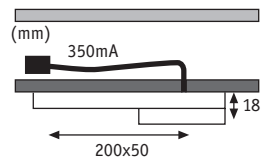

## Micro Line LED Setup

Metal/Acrylic Metal/Acrílico Metallo/Acricico



Brushed iron Hierro mateado Ferro spazzolato

incl. 3x3,2 W &lt; A++-A

3x250 lm, 2.700 K

∠ 120°

230 V, incl. ⚡ 15 VA

EAN 4000870 935675

935.67

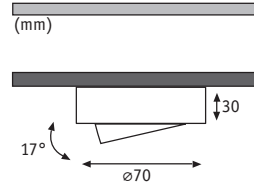

G4

800.22  
831.17

LED □ = 414-452

12V □ = 459-462

**Micro Line Dress**

Aluminium Aluminium Alluminio



White Blanco Bianco

max. 20 W < A++-E

12 V  
EAN 4000870 935149  
935.14



Brushed iron Hierro mateado Ferro spazzolato

max. 20 W < A++-E

12 V  
EAN 4000870 935125  
935.12



Chrome Cromo Cromo

max. 20 W < A++-E

12 V  
EAN 4000870 935118  
935.11



**Smart Home** □ = 386-403

Comfortably control your lighting with your smart phone or remote control, using the additional products from the Smart Home chapter (P. 386-403).

Controle su luz cómodamente mediante el smartphone o el mando a distancia con los productos complementarios del capítulo Smart Home (p. 386-403)

Comandate le vostre luci comodamente utilizzando lo smartphone o il telecomando con i prodotti supplementari del capitolo Smart Home (pag. 386-403).

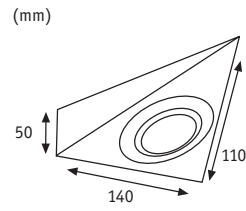
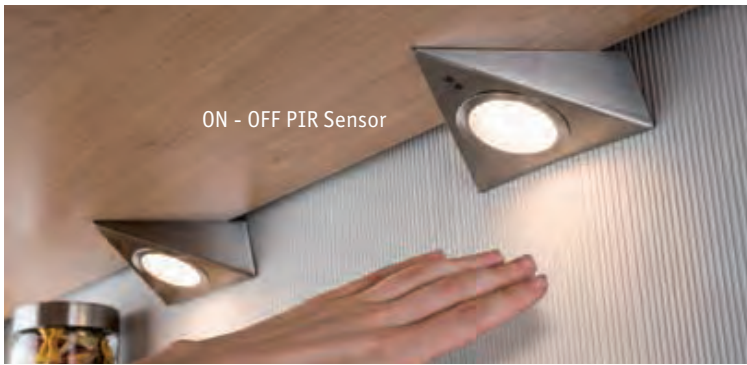

**Micro Line LED Triangle Sensor** Metal/Glass Metal/Cristal Metallo/Vetro



Brushed iron Hierro mateado Ferro spazzolato

**incl. 3x2,8 W** <math>A^{++}</math>-A  
 3x170 lm, 2.700 K  
 $\sphericalangle$  100°  
 230/12 V, incl.  $\text{⚡}$  12 VA  
 EAN 4000870 935729  
**935.72**

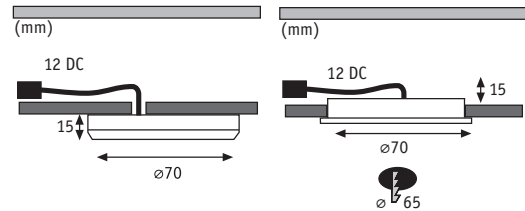

**Micro Line LED Platy** Polycarbonate Policarbonato Policarbonato

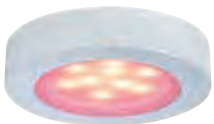

Matt white Blanco mate Bianco opaco

**incl. 3x1 W**  
 3x14 lm  
 $\sphericalangle$  120°  
 230/12 V, incl.  $\text{⚡}$  7,5 VA  
 EAN 4000870 935682  
**935.68**

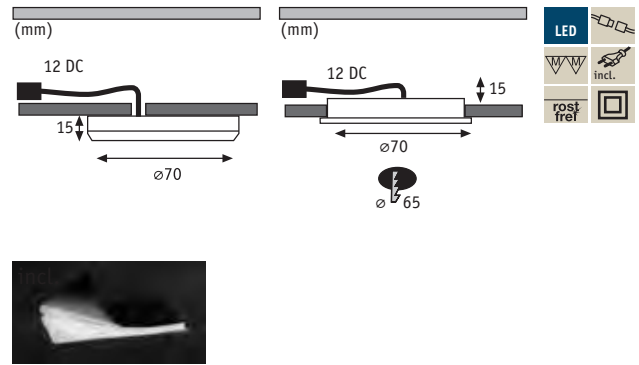
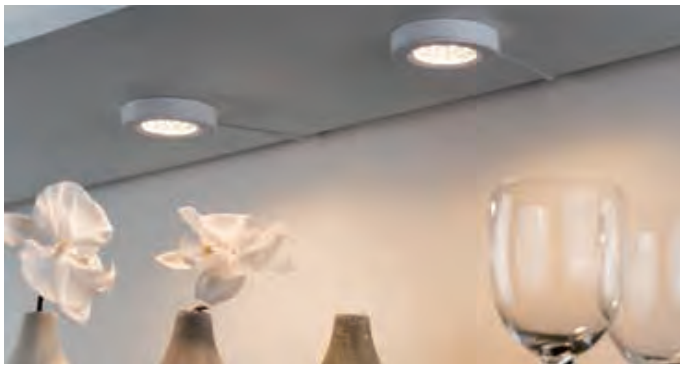

**Micro Line LED Platy**

Plastic Plástico Plastica

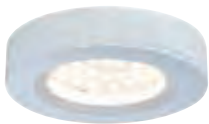

Matt white Blanco mate Bianco opaco

**incl. 3×2,5 W** <A++-A

3×170 lm, 3.000 K

∠ 105°

230/12 V, incl. ⚡ 7,5 VA

EAN 4000870 935736

**935.73**



Chrome matt Cromo mate Cromo opaco

**incl. 3×2,5 W** <A++-A

3×170 lm, 3.000 K

∠ 105°

230/12 V, incl. ⚡ 7,5 VA

EAN 4000870 935804

**935.80**

000

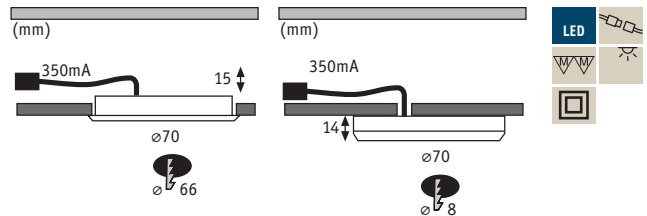

**Micro Line LED Platy**

Metal Metal Metallo



Aluminium Aluminio Alluminio

**incl. 3×3 W** <A++-A

3×244 lm, 2.700 K

∠ 180°

230 V, incl. ⚡ 12 VA

EAN 4000870 935477

**935.47**

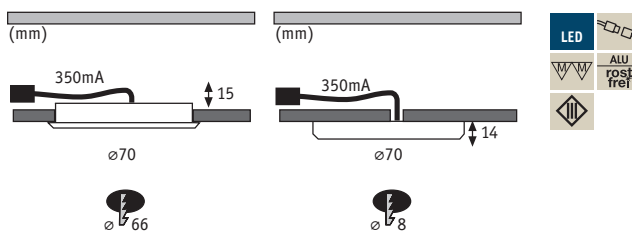

Micro Line LED Plane

Metal Metal Metallo



Aluminium Aluminio Alluminio

incl. 1×3 W &lt; A++-A

235 lm, 2.700 K

∠ 120°, 72 cd

EAN 4000870 925874

925.87

Trafo/Power Supply □= 404-414

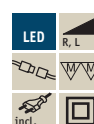
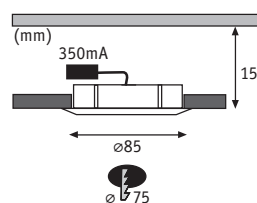
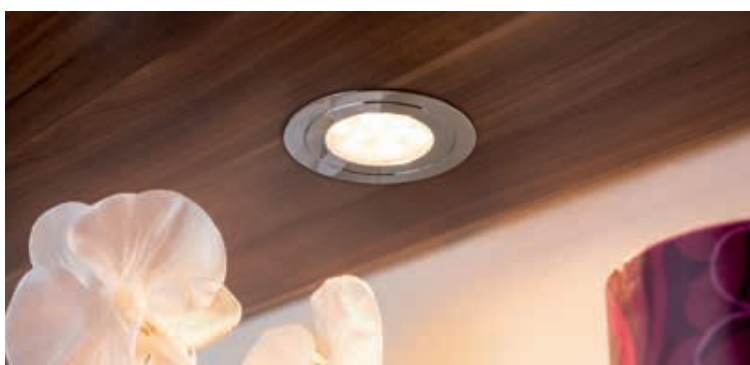

Micro Line LED Circuit

Metal Metal Metallo



Matt white Blanco mate Bianco opaco

incl. 3×5,6 W &lt; A++-A

3×420 lm, 2.700 K

∠ 96°, 180 cd

230 V, incl. □= 17,5 VA

EAN 4000870 935699

935.69



Brushed iron Hierro mateado Ferro spazzolato

incl. 3×5,6 W &lt; A++-A

3×420 lm, 2.700 K

∠ 96°, 180 cd

230 V, incl. □= 17,5 VA

EAN 4000870 935705

935.70



Chrome Cromo Cromo

incl. 3×5,6 W &lt; A++-A

3×420 lm, 2.700 K

∠ 96°, 180 cd

230 V, incl. □= 17,5 VA

EAN 4000870 935712

935.71



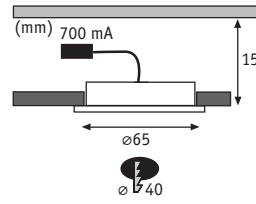

**Micro Line Whirl Mini LED**

Acrylic Acrílico Acrilico



Satin Satinado Satinato

**incl. 1x2,4 W**

A++-A

115 lm, 2.700 K

∠ 100°

230 V, incl. ⚡ 3 VA

EAN 4000870 998663

**998.66**

**incl. 3x2,4 W**

A++-A

3x115 lm, 2.700 K

∠ 100°

230 V, incl. ⚡ 7 VA

EAN 4000870 998656

**998.65**

000

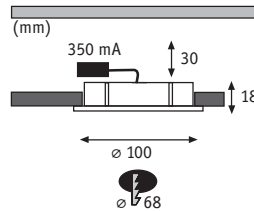

**Micro Line Deco LED**

Metal/Acrylic Metal/Acrílico Metallo/Acrilico



Chrome matt/Clear Cromo mate/Transparente Cromo opaco/Trasparente

**incl. 3x3 W**

A++-A

3.000 K

∠ 110°, 75 cd

230 V, incl. ⚡ 10 VA

EAN 4000870 935439

**935.43**



Chrome matt/Clear Cromo mate/Transparente Cromo opaco/Trasparente

**incl. 3x3 W**

A++-A

6.500 K

∠ 110°, 75 cd

230 V, incl. ⚡ 10 VA

EAN 4000870 983522

**983.52**

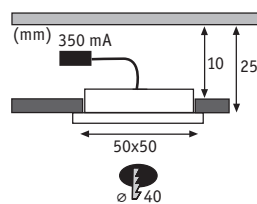
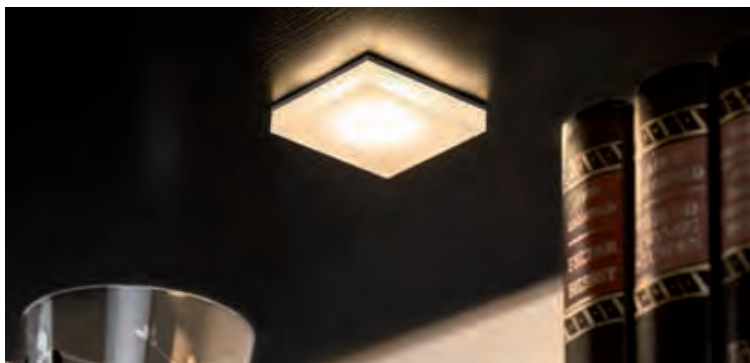

Micro Line LED Fleecy

Acrylic Acrílico Acrílico



Satin Satinado Satinato

incl. 3×1,3 W &lt; A++-A

3×70 lm, 2.700 K  
 230 V, incl. ⚡ 3,6 VA  
 EAN 4000870 935743  
**935.74**



Satin Satinado Satinato

incl. 3×1,3 W &lt; A++-A

3×78 lm, 4.000 K  
 230 V, incl. ⚡ 3,6 VA  
 EAN 4000870 935750  
**935.75**

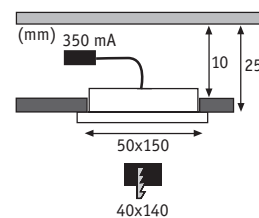

Micro Line LED Fleecy

Acrylic Acrílico Acrílico



Satin Satinado Satinato

incl. 3×3,6 W &lt; A++-A

3×218 lm, 2.700 K  
 230 V, incl. ⚡ 9 VA  
 EAN 4000870 935767  
**935.76**



Satin Satinado Satinato

incl. 3×3,6 W &lt; A++-A

3×233 lm, 4.000 K  
 230 V, incl. ⚡ 9 VA  
 EAN 4000870 935774  
**935.77**

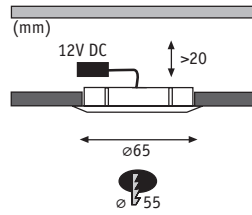

**Micro Line LED**

▣ Stainless steel Acero inoxidable Acciaio legato

▶ Can be switched on and off with a proximity switch

▶ Encendido y apagado mediante sensor de proximidad

▶ Accensione e spegnimento con interruttore di prossimità



☞ Stainless steel Acero inoxidable Acciaio legato

**incl. 3×2,8 W** <math>\triangleleft</math> A++-A  
 3×170 lm, 2.700 K  
 <math>\sphericalangle</math> 100°  
 230/12 V, incl. <math>\rightarrow</math> 12 VA  
 EAN 4000870 935590  
**935.59**

000

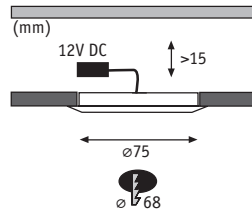

**Micro Line LED**

▣ Metal Metal Metallo

▶ Luminous colour adjustable with touch switch

▶ Colores de luz ajustables con interruptor táctil

▶ Colore della luce regolabile con interruttore touch



☞ Matt aluminium Aluminio mate Alluminio opaco

**incl. 3×2,6 W** <math>\triangleleft</math> A++-A  
 3×180 lm, 2.700 - 6.500 K  
 <math>\sphericalangle</math> 100°  
 230 V, incl. <math>\rightarrow</math> 12 VA  
 EAN 4000870 935606  
**935.60**

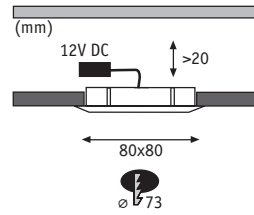
**Micro Line LED**

Stainless steel Acero inoxidable Acciaio legato

- ▶ Can be switched on and off with a proximity switch
- ▶ Encendido y apagado mediante sensor de proximidad
- ▶ Accensione e spegnimento con interruttore di prossimità



Stainless steel Acero inoxidable Acciaio legato

**incl. 3x3,6 W** <math>\langle A^{++}-A</math>

3x180 lm, 2.700 K

&lt;math&gt;\sphericalangle 75^\circ&lt;/math&gt;

230 V, incl. &lt;math&gt;\pm 12&lt;/math&gt; VA

EAN 4000870 935583

**935.58**

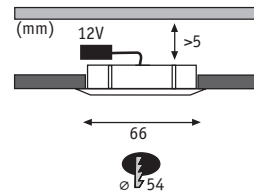

## Micro Line LED

Metal Metal Metallo



White Blanco Bianco

incl. 3×1 W &lt; A++-A

3×34 lm, 2.700 K  
 230/12 V, incl. 3,6 VA  
 EAN 4000870 998151  
**998.15**



Brushed iron Hierro mateado Ferro spazzolato

incl. 3×1 W &lt; A++-A

3×34 lm, 2.700 K  
 230/12 V, incl. 3,6 VA  
 EAN 4000870 998120  
**998.12**



Chrome Cromo Cromo

incl. 3×1 W &lt; A++-A

3×34 lm, 2.700 K  
 230/12 V, incl. 3,6 VA  
 EAN 4000870 998144  
**998.14**

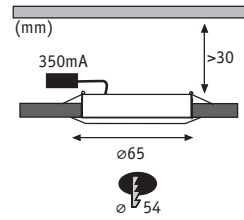

## Micro Line LED

Metal Metal Metallo



White Blanco Bianco

**incl. 1×4,5 W** <A++-A

305 lm, 2.700 K

⊘ 180°

230 V, incl. 6 VA

EAN 4000870 935552

**935.55** **incl. 3×4,5 W** <A++-A

3×305 lm, 2.700 K

⊘ 180°

230 V, incl. 12 VA

EAN 4000870 935545

**935.54**

Brushed iron Hierro mateado Ferro spazzolato

**incl. 1×4,5 W** <A++-A

305 lm, 2.700 K

⊘ 180°

230 V, incl. 6 VA

EAN 4000870 935569

**935.56** **incl. 3×4,5 W** <A++-A

3×305 lm, 2.700 K

⊘ 180°

230 V, incl. 12 VA

EAN 4000870 935538

**935.53**

Chrome Cromo Cromo

**incl. 3×4,5 W** <A++-A

3×305 lm, 2.700 K

⊘ 180°

230 V, incl. 9 VA

EAN 4000870 935521

**935.52**



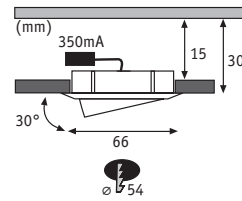

## Micro Line schwenkbar LED 230V

Metal Metal Metallo



White Blanco Bianco

**incl. 1×4,2 W** <A++-A  
320 lm, 2.700 K  
230 V, incl.  $\text{⊖}$  6,3 VA  
EAN 4000870 920923  
**920.92**

**incl. 3×4,2 W** <A++-A  
3×320 lm, 2.700 K  
230 V, incl.  $\text{⊖}$  13 VA  
EAN 4000870 920916  
**920.91**



Brushed iron Hierro mateado Ferro spazzolato

**incl. 1×4,2 W** <A++-A  
320 lm, 2.700 K  
230 V, incl.  $\text{⊖}$  6,3 VA  
EAN 4000870 920909  
**920.90**

**incl. 3×4,2 W** <A++-A  
3×320 lm, 2.700 K  
230 V, incl.  $\text{⊖}$  13 VA  
EAN 4000870 920893  
**920.89**



Chrome Cromo Cromo

**incl. 1×4,2 W** <A++-A  
320 lm, 2.700 K  
230 V, incl.  $\text{⊖}$  6,3 VA  
EAN 4000870 920886  
**920.88**

**incl. 3×4,2 W** <A++-A  
3×320 lm, 2.700 K  
230 V, incl.  $\text{⊖}$  13 VA  
EAN 4000870 920879  
**920.87**

000

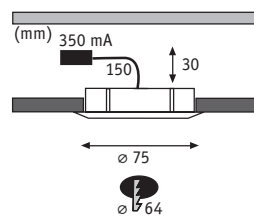

### Micro Line HighPower LED

Aluminium Aluminium Alluminio



Chrome matt Cromo mate Cromo opaco

incl. 3x3 W A++-A

3.000 K

∠ 100°, 70 cd

230 V, incl.  $\text{⚡}$  10 VA

EAN 4000870 935446

**935.44**

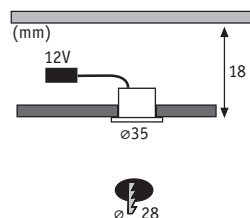

### Micro Line Mini LED

Metal Metal Metallo



Brushed iron Hierro mateado Ferro spazzolato

incl. 5x0,4 W A++-A

5x20 lm, 2.700 K

∠ 90°

230/12 V, incl.  $\text{⚡}$  3,6 VA

EAN 4000870 935866

**935.86**



incl. 5x0,4 W A++-A

5x20 lm, 6.500 K

∠ 90°

230/12 V, incl.  $\text{⚡}$  3,6 VA

EAN 4000870 935880

**935.88**

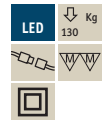
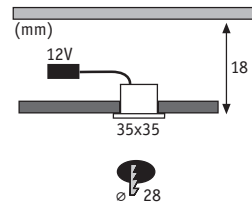

Micro Line Mini LED

☒ Metal Metal Metallo



🔗 Brushed iron Hierro mateado Ferro spazzolato

**incl. 5×0,4 W** <A++-A

5×20 lm, 2.700 K

☒ 90°

230/12 V, incl. ⚡ 3,6 VA

EAN 4000870 935873

**935.87**

**incl. 5×0,4 W** <A++-A

5×20 lm, 6.500 K

☒ 90°

230/12 V, incl. ⚡ 3,6 VA

EAN 4000870 935897

**935.89**

000

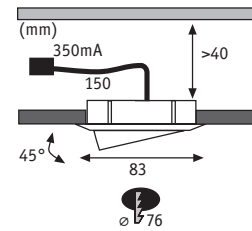

Micro Line Drilled Alu LED

☒ Aluminium Aluminio Alluminio



🔗 Turned aluminium Aluminio torneado Alluminio tornito

**incl. 3×3 W** <A++-A

3.000 K

☒ 30°, 613 cd

230 V, incl. ⚡ 10 VA

EAN 4000870 935415

**935.41**

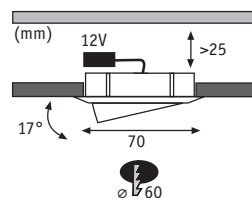

G4

800.22  
831.17

LED □= 414-452

12V □= 459-462

## Micro Line Dress

Aluminium Aluminio Alluminio



Brushed iron Hierro mateado Ferro spazzolato

max. 20 W

A++-E

12 V

EAN 4000870 935262

935.26



Chrome Cromo Cromo

max. 20 W

A++-E

12 V

EAN 4000870 935255

935.25

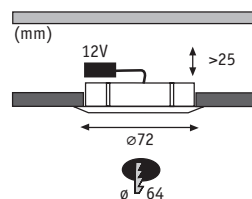

G4

831.15  
831.17

LED □= 414-452

12V □= 459-462

## Micro Line Klipp Klapp

Metal/Glass Metal/Cristal Metallo/Vetro



White Blanco Bianco

max. 20 W

A++-E

12 V

EAN 4000870 984666

984.66



Brushed iron Hierro mateado Ferro spazzolato

max. 20 W

A++-E

12 V

EAN 4000870 984079

984.07



Chrome Cromo Cromo

max. 20 W

A++-E

12 V

EAN 4000870 984024

984.02

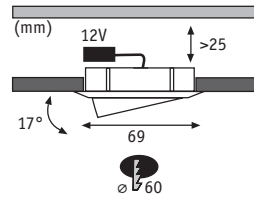
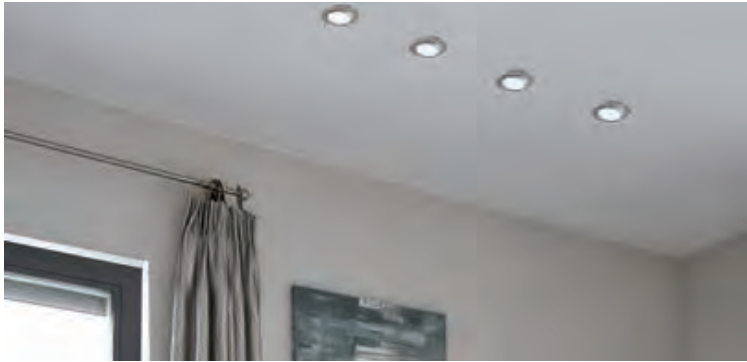

G4

831.15  
831.17

LED □= 414-452

12V □= 459-462

Micro Line Swivel

☒ Metal/Glass Metal/Cristal Metallo/Vetro



☞ Brushed iron Hierro mateado Ferro spazzolato

**max. 20 W** < A++-E

12 V  
EAN 4000870 984741  
**984.74** ☞



☞ Chrome Cromo Cromo

**max. 20 W** < A++-E

12 V  
EAN 4000870 984765  
**984.76** ☞



☞ Black Negro Nero

**max. 20 W** < A++-E

12 V  
EAN 4000870 984710  
**984.71** ☞

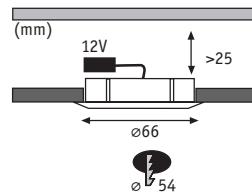
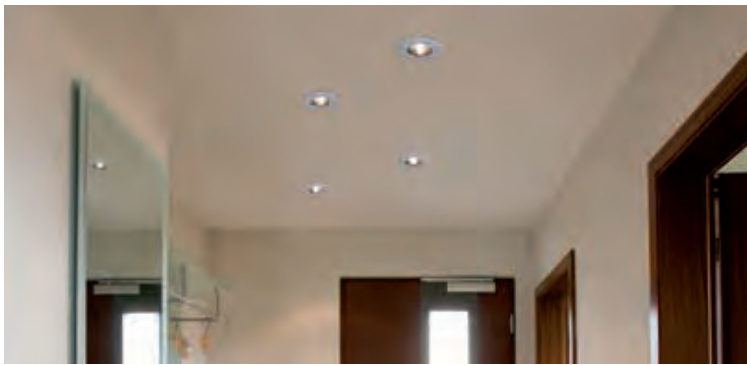

G4  
 831.15  
 831.17  
**LED** □= 414-452  
**12V** □= 459-462

**Micro Line Structure** Metal/Glass Metal/Cristal Metallo/Vetro



White Blanco Bianco

**max. 20 W** A++-E  
 12 V  
 EAN 4000870 984321  
**984.32**



Brushed iron Hierro mateado Ferro spazzolato

**max. 20 W** A++-E  
 12 V  
 EAN 4000870 984499  
**984.49**



Chrome Cromo Cromo

**max. 20 W** A++-E  
 12 V  
 EAN 4000870 984628  
**984.62**

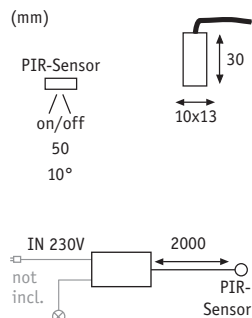
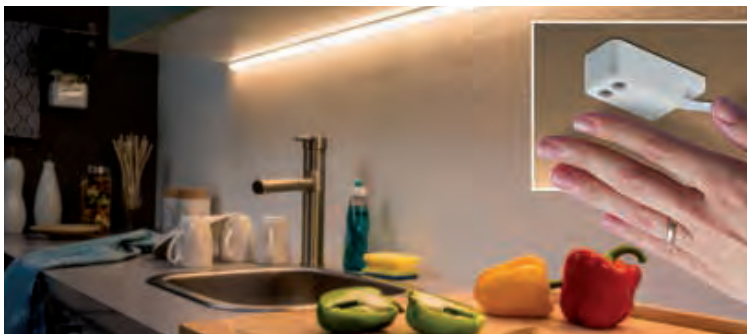

**PIR-Sensor 230V** Plastic Plástico Plastica

- ▶ Proximity switch for switching on and off the LED stripes and other products
- ▶ Max. 75 W (magnetic transformers)
- ▶ Max. 60 W (electronic load)
- ▶ Max. 250 W (light bulbs)
- ▶ Interruptor de proximidad para encender/apagar regletas LED-stripes y otros productos
- ▶ Máx. 75 W (transformadores magnéticos)
- ▶ Máx. 60 W (carga electrónica)
- ▶ Máx. 250 W (lámparas incandescentes)
- ▶ Interruteur de proximité Marche/Arrêt des rubans LED et autres produits
- ▶ Max. 75 W (trasformatori magnetici)
- ▶ Max. 60 W (carico elettronico)
- ▶ Max. 250 W (lampadine a incandescenza)



White Blanco Bianco

**max. 60 W**  
 230 V  
 EAN 4000870 935811  
**935.81**





Downlights | 2Easy

*Combine them yourself! Everything is possible!  
 ;Haga sus propias combinaciones! Todo es posible!  
 Scegliete da soli le combinazioni! Tutto è possibile!*



**Mounting rings**  
(Spot-Set)

**Aros de montaje**  
(Spot-Set)

**Anelli per montaggio**  
(Spot-Set)

**Choose your light**  
(Basic)

**Selección su luz**  
(Basic)

**Scegliete la vostra luce**  
(Basic)

**Install – plug together**  
The custom light solution is ready  
And what is your taste in lighting?

**instalar - acoplar**  
La solución lumínica individual está lista.  
¿Y qué tipo de luz le gusta?

**Installare - assemblare**  
La vostra soluzione di illuminazione è pronta! Che gusti avete in fatto di luce?

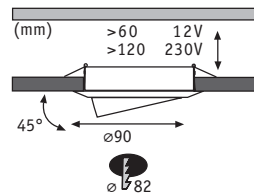

Basic  
□ = 380

2Easy Spot-Set Premium

Aluminium Aluminium Alluminio



Turned aluminium Aluminium torneado Alluminio tornito

max. 3×35 W A++-E  
EAN 4000870 925942  
925.94

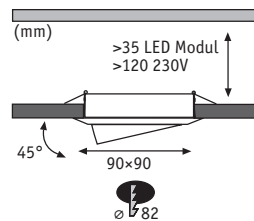

Basic  
□ = 380

2Easy Spot-Set Premium

Aluminium Aluminium Alluminio



Brushed aluminium Aluminium mateado Alluminio spazzolato

max. 3×35 W A++-E  
EAN 4000870 925959  
925.95

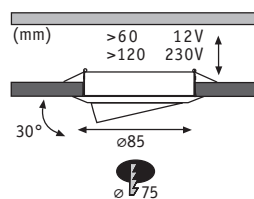

Basic  
□ = 380

2Easy Spot-Set Premium

Aluminium Aluminium Alluminio



Turned aluminium Aluminium torneado Alluminio tornito

max. 3×35 W A++-E  
EAN 4000870 965283  
965.28

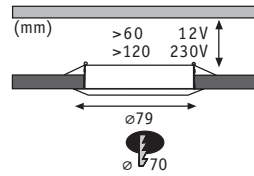

**2Easy Spot-Set Premium**

Aluminium zinc / Aluminio cinc / Alluminio zincato



White Blanco Bianco



Brushed iron Hierro mateado  
Ferro spazzolato



Chrome Cromo Cromo

**max. 3×50 W** <A++-E  
EAN 4000870 997390  
**997.39**

**max. 3×50 W** <A++-E  
EAN 4000870 997383  
**997.38**

**max. 3×50 W** <A++-E  
EAN 4000870 997406  
**997.40**

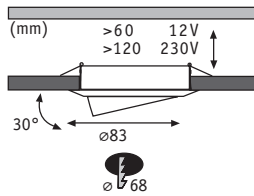

**2Easy Spot-Set Premium**

Aluminium zinc / Aluminio cinc / Alluminio zincato



White Blanco Bianco



Brushed iron Hierro mateado  
Ferro spazzolato



Chrome Cromo Cromo

**max. 3×50 W** <A++-E  
EAN 4000870 997420  
**997.42**

**max. 3×50 W** <A++-E  
EAN 4000870 997437  
**997.43**

**max. 3×50 W** <A++-E  
EAN 4000870 997444  
**997.44**

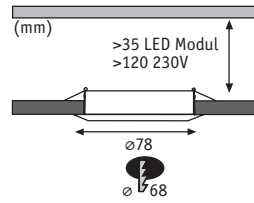

Basic  
□ = 380

2Easy Spot-Set Premium Nova

Aluminium zinc Aluminium cinc Alluminio zincato

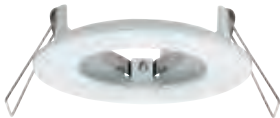

Matt white Blanco mate  
Bianco opaco

max. 3×35 W <math>\langle A^{++}-E</math>  
EAN 4000870 936351  
936.35 new



Turned aluminium  
Aluminio torneado  
Alluminio tornito

max. 3×35 W <math>\langle A^{++}-E</math>  
EAN 4000870 936368  
936.36 new



Brushed iron Hierro mateado  
Ferro spazzolato

max. 3×35 W <math>\langle A^{++}-E</math>  
EAN 4000870 936375  
936.37 new



Rosé gold Oro rosa Oro rosa

max. 3×35 W <math>\langle A^{++}-E</math>  
EAN 4000870 936382  
936.38 new

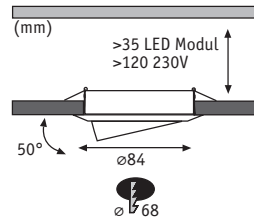

Basic  
□ = 380

2Easy Spot-Set Premium Nova

Aluminium zinc Aluminium cinc Alluminio zincato



Matt white Blanco mate  
Bianco opaco

max. 3×35 W <math>\langle A^{++}-E</math>  
EAN 4000870 936436  
936.43 new



Turned aluminium  
Aluminio torneado  
Alluminio tornito

max. 3×35 W <math>\langle A^{++}-E</math>  
EAN 4000870 936443  
936.44 new



Brushed iron Hierro mateado  
Ferro spazzolato

max. 3×35 W <math>\langle A^{++}-E</math>  
EAN 4000870 936450  
936.45 new



Rosé gold Oro rosa Oro rosa

max. 3×35 W <math>\langle A^{++}-E</math>  
EAN 4000870 936467  
936.46 new

*Combine them yourself! Everything is possible!*  
*¡Haga sus propias combinaciones! Todo es posible!*  
*Scegliete da soli le combinazioni! Tutto è possibile!*

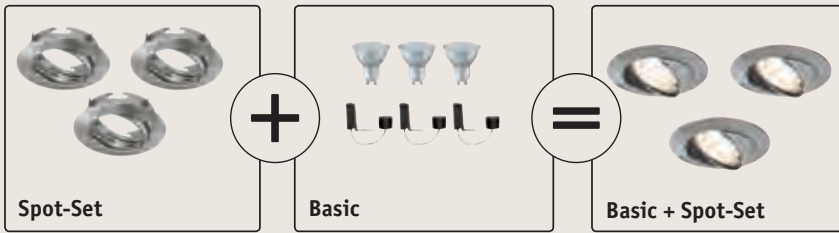

**Spot-Set**  
 = 377-379

**2Easy Basic LED Coin 230V**

Plastic Plástico Plastica



Satin Satinado Satinato

**incl. 3×6,8 W**

3×592 lm (Modul), 2.700 K  
 <math>\sphericalangle</math> 120°  
 230 V  
 EAN 4000870 938867

**938.86 new**

**incl. 3×6,8 W**

3×633 lm (Modul), 2.700 K  
 <math>\sphericalangle</math> 120°  
 230 V  
 EAN 4000870 938874

**938.87 new**



**2Easy Basic LED Coin 230V**

Plastic Plástico Plastica



Satin Satinado Satinato

**incl. 3×6,8 W**

3×430 lm (Modul), 2.700 K  
 230 V  
 EAN 4000870 938201

**938.20**



**2Easy Basic LED Coin 230V**

Plastic Plástico Plastica



Satin Satinado Satinato

**incl. 3×7 W**

3×380 lm (Modul), 2.700 K  
 <math>\sphericalangle</math> 105°  
 230 V  
 EAN 4000870 938393

**938.39**



**2Easy Basic LED 230V**



Warm white Blanco cálido Bianco caldo

**incl. 3×3,5 W**

3×230 lm, 2.700 K  
 230 V  
 EAN 4000870 927946

**927.94**



**2Easy Basic LED 230V**



Warm white Blanco cálido Bianco caldo

**incl. 3×8 W**

3×430 lm, 2.700 K  
 230 V  
 EAN 4000870 927953

**927.95**







- ▶ On and off switch up to 3500 W
  - ▶ Up to 6 transmitters, self-learning
  - ▶ Easy group switching function
  - ▶ Socket with child safety mechanism
  - ▶ Range of up to 30 m
  - ▶ Standby < 0.6 W
- ▶ Encendido y apagado hasta 3500 W
  - ▶ Hasta 6 emisores, sencilla autoprogramación
  - ▶ Sencilla función de conmutación por grupos
  - ▶ Toma eléctrica con seguro para niños
  - ▶ Tiene un alcance de hasta 30 m
  - ▶ Standby < 0,6 W
- ▶ Accensione e spegnimento fino a 3500 W
  - ▶ Possibilità di uso di fino a 6 trasmettitori, semplice autoprogrammazione
  - ▶ Semplice funzione di commutazione di gruppo
  - ▶ Presa con sicurezza bambini
  - ▶ Portata fino a 30 m
  - ▶ Standby < 0,6 W



**Premium Line radio adapter plug 433 MHz**  
**Adaptador por radio Premium Line Line 433 MHz**  
**Adattatore via radio premium Line 433 MHz**

🎨 White Blanco Bianco

max. 3.500 W

230 V

⌀110 ⇄52 ↗32 mm

EAN 4000870 975497

**975.49** 📦



- ▶ Use as many wall transmitters as you like, simultaneously
  - ▶ Affix with double-sided adhesive tape or screws to walls, glass, tiles or even furniture
  - ▶ Also transmits through walls and doors
  - ▶ Range of up to 30 m
  - ▶ Battery operated (1x A23 12V DC)
- ▶ Pueden emplearse simultáneamente tantos emisores de pared como se desee
  - ▶ Fijación en paredes, cristal, azulejos o incluso muebles mediante tornillos o cinta adhesiva por ambas caras
  - ▶ También transmite a través de paredes y puertas
  - ▶ Tiene un alcance de hasta 30 m
  - ▶ Funciona con pilas (1x A23 12 V DC)
- ▶ Possibilità di utilizzare contemporaneamente più trasmettitori a parete
  - ▶ Fissaggio con nastro biadesivo o viti su pareti, vetri, mattonelle o mobili
  - ▶ Trasmette anche attraverso pareti e porte
  - ▶ Portata fino a 30 m
  - ▶ Funzionamento a batteria (1x A23 12V DC)



**Premium line radio wall transmitter 433 MHz**  
**Emisor de pared por radio Premium line 433 MHz**  
**Trasmittitore a parete via radio Premium line 433 MHz**

🎨 White Blanco Bianco

⌀80 ⇄80 ↗17 mm

EAN 4000870 975527

**975.52** 📦





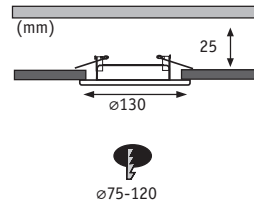

**Downlight adapter**

☒ Metal Metal Metallo

- ▶ For 51 mm Premium and Quality fixed and swivelling and 35 mm Quality swivelling
  - ▶ For recessed lighting with an outside diameter > 76 mm
  - ▶ Shallow installation depth of only 25 mm
  - ▶ Diameter: 130 mm
- ▶ Premium y Quality de 51 mm en versión rígida y pivotable, Quality de 35 mm pivotable
  - ▶ Para lámparas empotrables de diámetro exterior >76 mm
  - ▶ Mínima profundidad de empotre de solo 25 mm
  - ▶ Diámetro: 130 mm
- ▶ Per Premium e Quality da 51 mm fissi e orientabili e Quality da 35 mm orientabili
  - ▶ Per faretti da incasso con diametro esterno di >76 mm
  - ▶ Profondità minima di incasso ridotta, di soli 25 mm
  - ▶ Diametro: 130 mm



🌀 White Blanco Bianco

**max. 50 W**

EAN 4000870 925058

**925.05** 📦



🌀 Brushed iron Hierro mateado Ferro spazzolato

**max. 50 W**

EAN 4000870 925065

**925.06** 📦

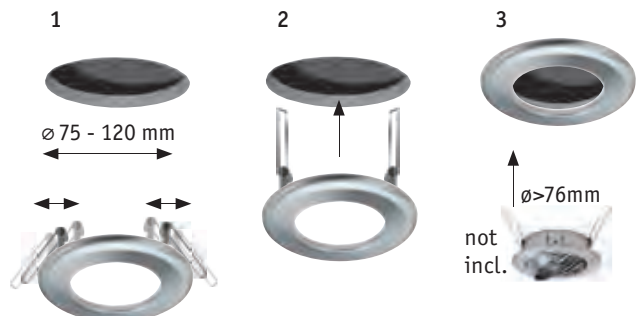

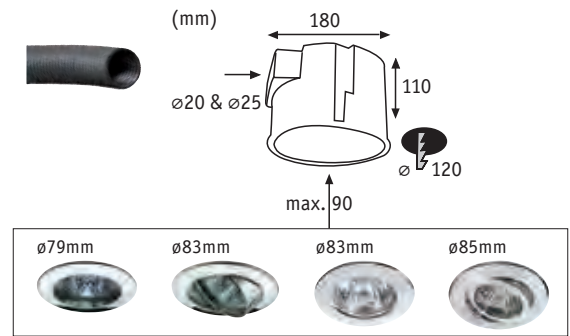

**Recessed fitting** ☒ Plastic Plástico Plastica  
**Carcasa incorporado**  
**Coppa da incasso**

- |   |  |  |
|---|--|--|
| <ul style="list-style-type: none"> <li>▶ Air tight = suitable for blower door (0,21m<sup>3</sup>/(hxm)+-10%)</li> <li>▶ Connection for corrugated pipes 20 + 25 mm</li> <li>▶ Additional cable inlet</li> <li>▶ Transformer cut-out removable</li> <li>▶ Centre-point determination possible by magnet</li> <li>▶ Fire retardant, 850°C-tested</li> </ul> | <ul style="list-style-type: none"> <li>▶ Hermético = apto para puertas de ventilador (0,21m<sup>3</sup>/(hxm)+-10%)</li> <li>▶ Conexión para tubo ondulado 20 + 25 mm</li> <li>▶ Pasacables adicional</li> <li>▶ Sección de transformador desmontable</li> <li>▶ Permite determinar el punto central con imán</li> <li>▶ Ignífugo, probado a 850 °C</li> </ul> | <ul style="list-style-type: none"> <li>▶ A tenuta d'aria = adatto per blower door (0,21m<sup>3</sup>/(hxm)+-10%)</li> <li>▶ Collegamento per tubi ondulati 20 + 25 mm</li> <li>▶ Passacavo aggiuntivo</li> <li>▶ Sezione del trasformatore rimovibile</li> <li>▶ Possibilità di rilevamento del punto centrale con magnete</li> <li>▶ Resistenza al fuoco fino a 850 °C testata</li> </ul> |
|---|--|--|



🌀 Grey Gris Grigio

**max. 35 W**  
 EAN 4000870 002506  
**250** ➡

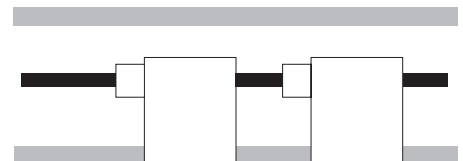

**Recessed fitting** ☒ Metal Metal Metallo  
**Carcasa incorporado**  
**Coppa da incasso**



🌀 Black Negro Nero

**max. 35 W**  
 12 V  
 EAN 4000870 002308  
**230** ➡

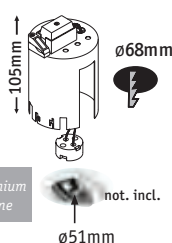

**max. 35 W**  
 230 V  
 EAN 4000870 002360  
**236** ➡

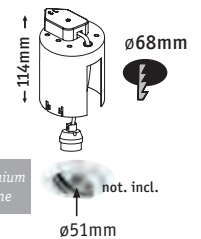

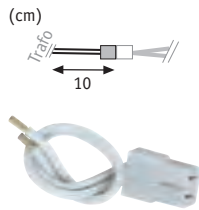

**Adapter for transformers with a clamp connection (2x1,5mm<sup>2</sup>)**  
**Adaptador para transformadores con conexión a presión (2x1,5mm<sup>2</sup>)**  
**Adattatore per trasformatore con collegamento a morsetti (2x1,5mm<sup>2</sup>)**

max. 150 W  
 12 V  
 EAN 4000870 979853  
**979.85**

Halogen  
12V



**12V, G4, GX5,3, GY6,35, GU5,3, GU4**

max. 50 W, G4 / GX5,3 / GY6,35  
 12 V  
 ⌀170 ↔15 ↗15 mm  
 EAN 4000870 002162  
**216**

Halogen  
12V

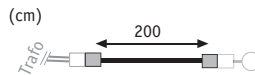

**200cm (2x0,75mm<sup>2</sup>)**

max. 105 W  
 12 V  
 0,75 mm<sup>2</sup> ↔2 m  
 EAN 4000870 979839  
**979.83**

Halogen  
12V

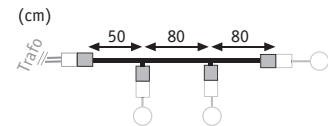

**210cm (2x0,75mm<sup>2</sup>)**

max. 3x35 W  
 12 V  
 0,75 mm<sup>2</sup> ↔2,1 m  
 EAN 4000870 979730  
**979.73**

Halogen  
12V



**12V, G4, GX5,3, GY6,35, GU5,3, GU4**

max. 75 W, G4 / GX5,3 / GY6,35  
 12 V  
 EAN 4000870 021897  
**218.9**

Halogen  
12V

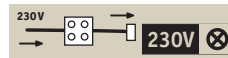

**230V GU, GZ10**

GZ10  
 230 V  
 EAN 4000870 002179  
**217**



**230V GU10 Box**

max. 50 W, GU10  
 230 V  
 ⌀23 ↔70 ↗35 mm  
 EAN 4000870 938102  
**938.10**

Halogen  
230V



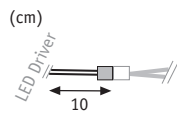
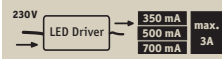

Adapter JST 1x0,1m, 350, 500, 700, 1000mA (2x0,5mm<sup>2</sup>)

↔0,1m  
EAN 4000870 002285  
228

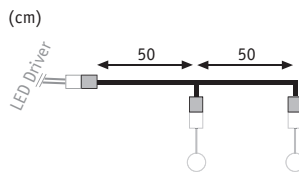

Adapter JST 1x1m, 350, 500, 700, 1000mA (2x0,5mm<sup>2</sup>)

↔1m  
EAN 4000870 002292  
229

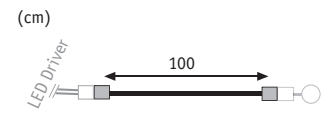

Adapter JST 1x1m, 350, 500, 700, 1000mA (2x0,5mm<sup>2</sup>)

↔1m  
EAN 4000870 002339  
233



**Circlip (Plastic)**  
Arandela de retención (Plástico)  
Anillo elastico (Plastica)



EAN 4000870 000205  
202000223



EAN 4000870 000212  
202000224



EAN 4000870 000274  
404001963

**Circlip (Metal)**  
Arandela de retención (Metal)  
Anillo elastico (Metallo)



ø35 mm  
EAN 4000870 000267  
404000753



ø51 mm  
EAN 4000870 000250  
404000752



ø35 mm  
EAN 4000870 000243  
404000126



ø51 mm  
EAN 4000870 000236  
404000125



ø35 mm  
EAN 4000870 938058  
938.05



ø51 mm  
EAN 4000870 937617  
937.61



ø35 mm  
EAN 4000870 938065  
938.06



ø51 mm  
EAN 4000870 937624  
937.62



# Smart Home

- 388 Bluetooth Low Energy
- 396 ZigBee
- 402 Smart Friends

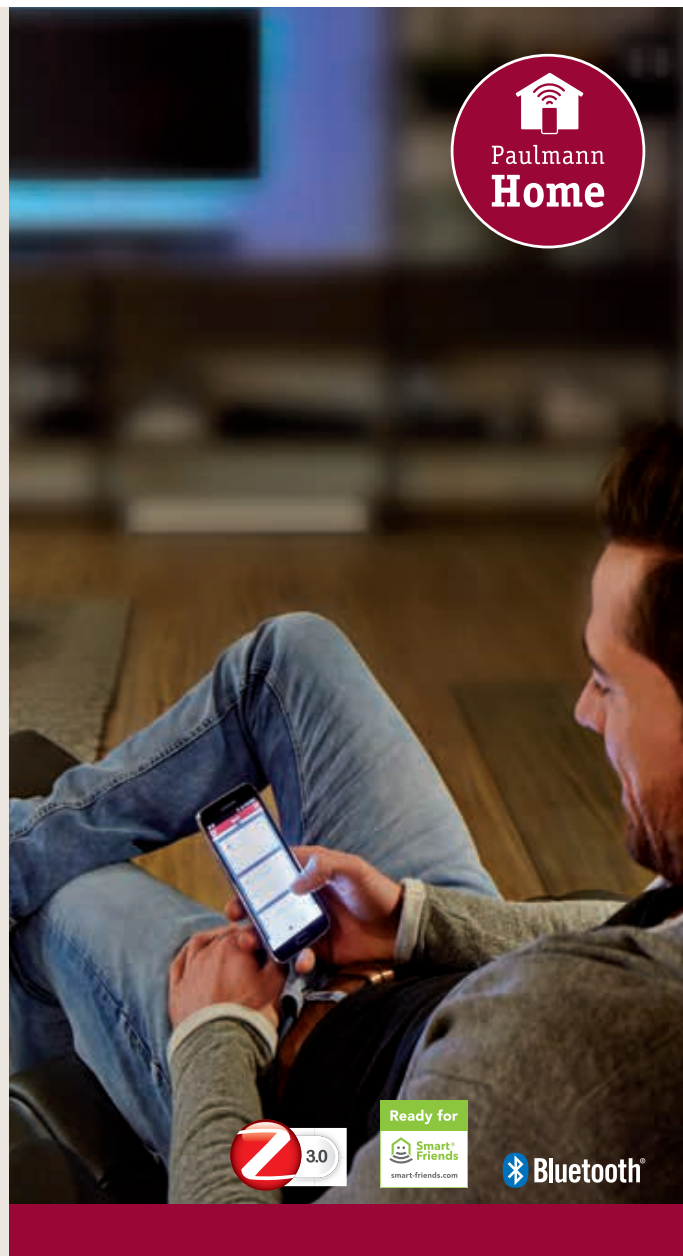

Lighting control

Control lumínico

Comando della luce

Lighting control  
and building control

Control lumínico  
más control de edificios

Comando della luce  
più comando dell'edificio

Building control  
including lighting control

Control de edificios,  
incluyendo control lumínico

Comando dell'edificio  
incl. comando della luce

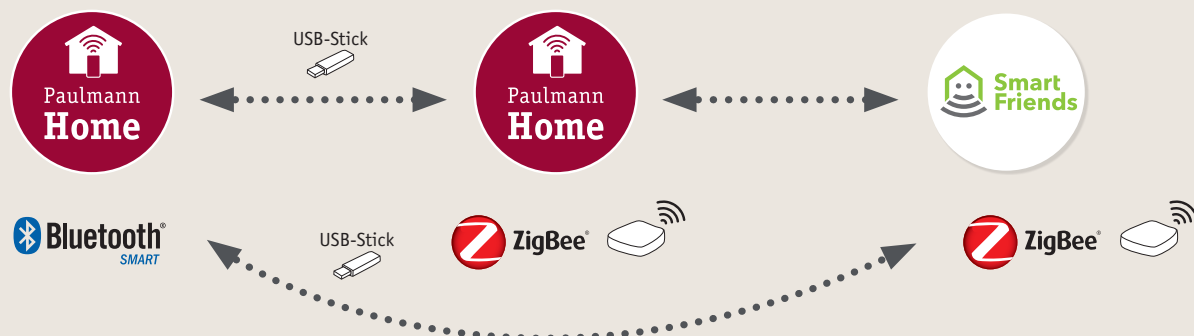

*One app for all functions*  
*Una aplicación para todas las funciones*  
*Una app per tutte le funzioni*

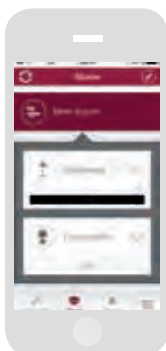
**Rooms**

Configure rooms individually and assign your luminaires to the rooms.

**Estancias**

Cree estancias individualmente y asígneles sus luminarias.

**Spazi**

Impostate spazi del tutto personalizzati a cui abbinare i vostri apparecchi.

**Luminaires, lamps, controllers**

Configure each of your luminaires as you want – with a name and a symbol.

**Luminarias, lámparas, controladores**

Cree cada una de sus luminarias como desee, con un nombre y un símbolo.

**Apparecchi, lampade, controller**

Impostate ciascuno dei vostri apparecchi come desiderate, dandogli un nome e un simbolo.

**Colour control**

Create the perfect mood in each room with RGB+W effect lighting, tunable white or simple dimming.

**Control del color**

Ya sea con efectos de luz RGB+W, blanco ajustable o simplemente luz regulable, cree el ambiente adecuado para cada estancia.

**Comando dei colori**

Che sia luce a effetto RGB+W, regolazione del bianco (Tunable White) o semplicemente dimming, immergete il vostro ambiente nell'atmosfera giusta.

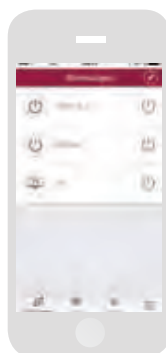
**Scenarios**

You can save your favourite settings and return everything to exactly how you like it at the press of a button

**Escenas**

Con su configuración favorita, puede ajustarlo todo según sus preferencias siempre que quiera, con solo un botón.

**Scene**

Con le vostre regolazioni preferite potete impostare sempre tutto come preferite premendo semplicemente un tasto.

**Favourites**

You can configure each luminaire as a favourite for extra prompt operation.

**Favoritos**

Puede marcar cada luminaria como favorita para poder operar con ella rápidamente.

**Preferiti**

Potete impostare ogni apparecchio come preferito per poterlo comandare velocemente.

**Timing**

You decide at what time your luminaire automatically turns on or off.

Your smartphone does not need to be present for the light to turn on.

**Control de tiempo**

Determine a qué hora debe encenderse o apagarse automáticamente su luminaria.

No hace falta que el smartphone se encuentre cerca en el momento del encendido/apagado.

**Comando temporale**

Stabilite a vostro piacimento a che ora deve accendersi o spegnersi automaticamente il vostro apparecchio.

Al momento dell'accensione lo smartphone non deve trovarsi necessariamente nelle vicinanze.



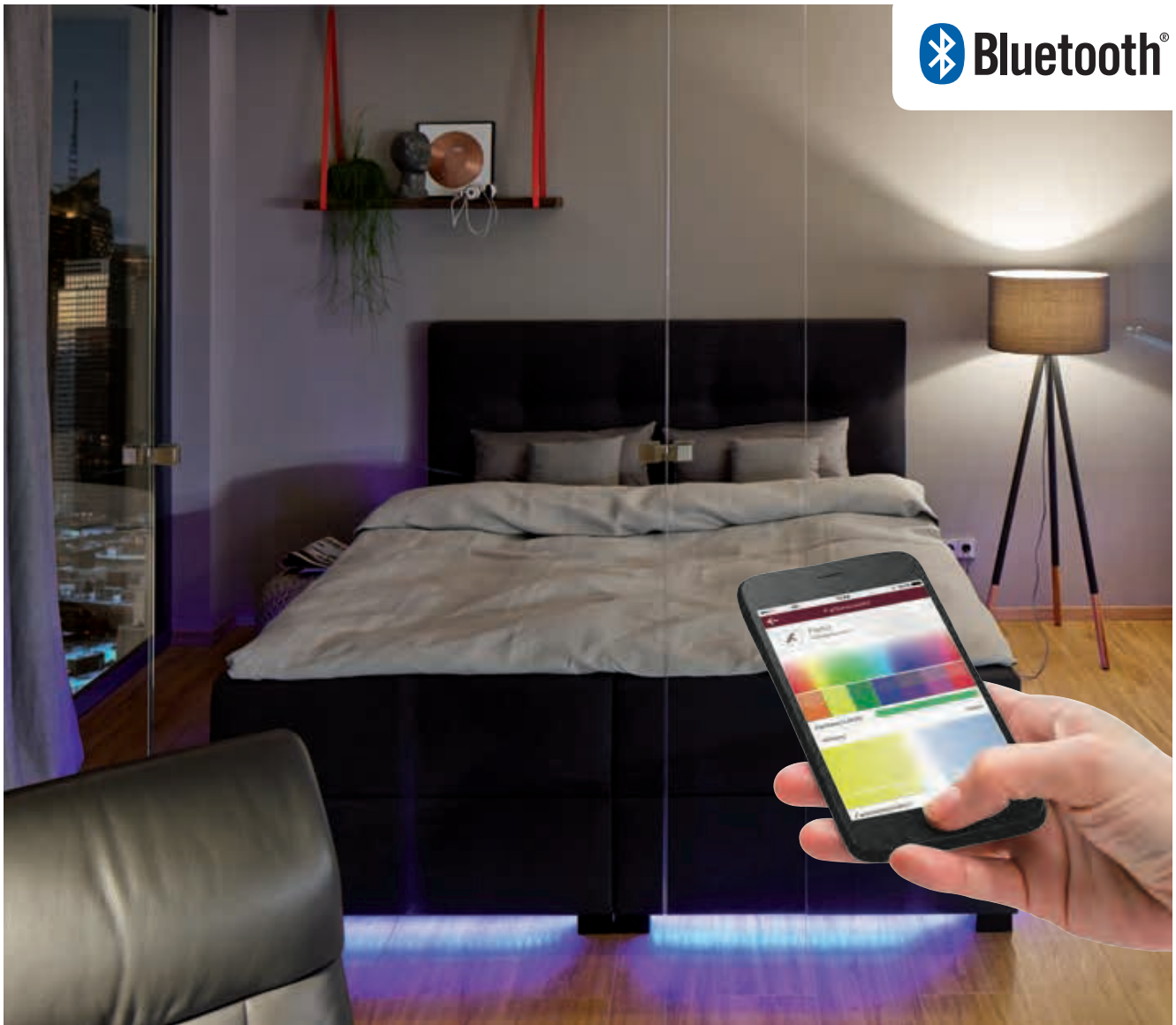

### Remote Control Boss

AAA/1,5V (Micro) × 2  
 ⌀18 ⇄48 ↗110 mm  
 EAN 4000870 500019  
**500.01**

- Black Plastic
- Negro Plástico
- Nero Plastica



### EuroPlug Switch

max. 400 W  
 230 V  
 Ω max. 400 W  
 C max. 75 W, I max. 75 W  
 ⌀103 ⇄62 ↗47 mm  
 EAN 4000870 500194  
**500.19** **new**

- White Plastic
- Blanco Plástico
- Bianco Plastica



### EuroPlug Switch/Dimm

max. 300 W  
 230 V  
 Ω max. 300 W, I max. 100 W  
 ⌀103 ⇄62 ↗47 mm  
 EAN 4000870 500200  
**500.20** **new**

- White Plastic
- Blanco Plástico
- Bianco Plastica



- 🔗 White 📦 Plastic
- 🔗 Blanco 📦 Plástico
- 🔗 Bianco 📦 Plastica



**Master Switch**

max. 500 W  
 220-240 V  
 $\Omega$  max. 500 W, C max. 75 W, I max. 75 W  
 $\varnothing$ 26  $\leftrightarrow$ 47  $\varnothing$ 136 mm  
 EAN 4000870 500170  
**500.17** **new**



**Master Switch/Dimm**

max. 300 W  
 220-240 V  
 $\Omega$  max. 300 W, I max. 100 W  
 $\varnothing$ 26  $\leftrightarrow$ 47  $\varnothing$ 136 mm  
 EAN 4000870 500187  
**500.18** **new**



- 🔗 Chrome matt/White 📦 Metal
- 🔗 Cromo mate/Blanco 📦 Metal
- 🔗 Cromo opaco/Bianco 📦 Metallo



**Set IceLED**

incl. 4x4 W  
 4x320 lm, 2.700 - 6.500 K  
 230/12 V, incl.  $\leftrightarrow$ 36 VA  
 $\varnothing$ 160 mm 2,5 mm<sup>2</sup>  $\leftrightarrow$ 10 m  
 EAN 4000870 500163  
**500.16** **new**

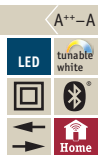

- 🔗 White 📦 Plastic
- 🔗 Blanco 📦 Plástico
- 🔗 Bianco 📦 Plastica









**Flaex LED Strip Set 5m RGB**

incl. 1x18 W  
 536 lm  
 $\angle$  120°  
 230/12 V, incl.  $\leftrightarrow$ 24 VA  
 $\varnothing$ 3 mm  $\varnothing$ 10,5 mm  $\leftrightarrow$ 5 m  
 EAN 4000870 500057  
**500.05** **new**









 Matt white  Plastic  
 Blanco mate  Plástico  
 Bianco opaco  Plastica



**Nox** A++-A





incl. 1x10,5 W  
 1.090 lm, 2.700 - 6.500 K  
 230 V, incl.  10,5 VA  
 ø170  $\varnothing$ 40 mm  
 EAN 4000870 500088  
**500.08 new**



**Nox** A++-A

incl. 1x14 W  
 1.490 lm, 2.700 - 6.500 K  
 230 V, incl.  14,5 VA  
 ø220  $\varnothing$ 40 mm  
 EAN 4000870 500095  
**500.09 new**









**Nox** A++-A

incl. 1x21 W  
 2.100 lm, 2.700 - 6.500 K  
 230 V, incl.  21 VA  
 ø300  $\varnothing$ 40 mm  
 EAN 4000870 500101  
**500.10 new**

   







 White  Plastic  
 Blanco  Plástico  
 Bianco  Plastica



**Premium Line LED LightSound** A++-A

incl. 1x6 W  
 630 lm, 2.700 K  
 $\sphericalangle$  110°  
 230/12 V, incl.  12 VA  
 $\updownarrow$ 39 ø117 mm  
 EAN 4000870 920961  
**920.96 new**

- ▶ Surface-mounted LightSound luminaire with integrated speaker and dimming function.
- ▶ Luminaria de superficie LightSound con altavoz y función de regulación.
- ▶ Apparecchi per montaggio a parete LightSound con altoparlante integrato e funzione dimming.
- ▶ Volume control and song selection directly via Bluetooth using a smart phone or tablet computer.
- ▶ Control de volumen y selección de canciones directamente por Bluetooth a través del smartphone o tableta
- ▶ Regolazione del volume e selezione canzone direttamente via Bluetooth tramite Smartphone o tablet.



- 🔗 White 📦 Plastic
- 🔗 Blanco 📦 Plástico
- 🔗 Bianco 📦 Plastica

for Strip  
☐ 191, 195



**YourLED Switch/Dimm Controller**

max. 60 W  
DC 12 V  
⤴19 ⤵39 ⤶80 mm  
EAN 4000870 500385  
**500.38** 📦 **new**



for RGB Color  
☐ = 190, 194



**YourLED RGB Controller**

max. 60 W  
DC 12 V  
⤴19 ⤵39 ⤶80 mm  
EAN 4000870 500392  
**500.39** 📦 **new**

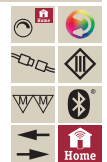

- 🔗 White 📦 Plastic
- 🔗 Blanco 📦 Plástico
- 🔗 Bianco 📦 Plastica



for MaxLED  
☐ 176-182



**MaxLED Switch/Dimm Controller**

max. 144 W  
DC 24 V  
⤴19 ⤵39 ⤶80 mm  
EAN 4000870 500026  
**500.02** 📦 **new**



for MaxLED  
☐ 185



**MaxLED TunableWhite Controller**

max. 144 W  
DC 24 V  
⤴19 ⤵39 ⤶80 mm  
EAN 4000870 500033  
**500.03** 📦 **new**



for MaxLED  
☐ 186

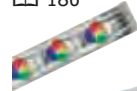

**MaxLED RGBW Controller**

max. 144 W  
DC 24 V  
⤴19 ⤵39 ⤶80 mm  
EAN 4000870 500040  
**500.04** 📦 **new**



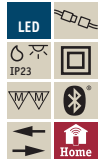
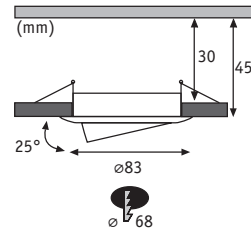







**Premium LED Smart Coin BLE**

A++-A

incl. 1x5 W  
490 lm, 2.700 K  
230/24 V, incl.  $\square$  6 VA  
 $\varnothing$ 83 mm  
EAN 4000870 920947  
**920.94**







-  Matt white  Aluminium zinc
-  Blanco mate  Aluminio cinc
-  Bianco opaco  Alluminio zincato



**Premium LED Smart Coin BLE**

A++-A

incl. 1x4,5 W  
560 + 530 lm, 2.700 - 6.500 K  
230/24 V, incl.  $\square$  6 VA  
 $\varnothing$ 83 mm  
EAN 4000870 920954  
**920.95**







-  Matt white  Aluminium zinc
-  Blanco mate  Aluminio cinc
-  Bianco opaco  Alluminio zincato



**Premium LED Smart Coin BLE**

A++-A

incl. 1x2,4 W  
80 lm  
230/24 V, incl.  $\square$  3 VA  
 $\varnothing$ 83 mm  
EAN 4000870 920930  
**920.93**







-  Matt white  Aluminium zinc
-  Blanco mate  Aluminio cinc
-  Bianco opaco  Alluminio zincato



**Premium LED Smart Coin BLE**

A++-A

incl. 1x5 W  
490 lm, 2.700 K  
230/24 V, incl.  $\square$  6 VA  
 $\varnothing$ 83 mm  
EAN 4000870 938447  
**938.44**







-  Brushed iron  Aluminium zinc
-  Hierro mateado  Aluminio cinc
-  Ferro spazzolato  Alluminio zincato



**Premium LED Smart Coin BLE**

A++-A

incl. 1x4,5 W  
560 + 530 lm, 2.700 - 6.500 K  
230/24 V, incl.  $\square$  6 VA  
 $\varnothing$ 83 mm  
EAN 4000870 938430  
**938.43**







-  Brushed iron  Aluminium zinc
-  Hierro mateado  Aluminio cinc
-  Ferro spazzolato  Alluminio zincato



**Premium LED Smart Coin BLE**

A++-A

incl. 1x2,4 W  
80 lm  
230/24 V, incl.  $\square$  3 VA  
 $\varnothing$ 83 mm  
EAN 4000870 938423  
**938.42**

-  Brushed iron  Aluminium zinc
-  Hierro mateado  Aluminio cinc
-  Ferro spazzolato  Alluminio zincato



**Goal**

A++-A

incl. 3x5,2 W  
3x515 lm, 2.700 K  
 $\sphericalangle$  110°  
230/24 V, incl.  $\square$  20 VA  
 $\varnothing$ 83 mm  
EAN 4000870 500064  
**500.06 new**







-  Matt white  Aluminium zinc
-  Blanco mate  Aluminio cinc
-  Bianco opaco  Alluminio zincato



**Goal**

A++-A

incl. 3x5,2 W  
3x515 lm, 2.700 K  
 $\sphericalangle$  110°  
230/24 V, incl.  $\square$  20 VA  
 $\varnothing$ 83 mm  
EAN 4000870 500071  
**500.07 new**

-  Brushed iron  Aluminium zinc
-  Hierro mateado  Aluminio cinc
-  Ferro spazzolato  Alluminio zincato



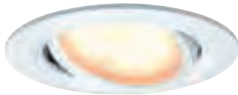
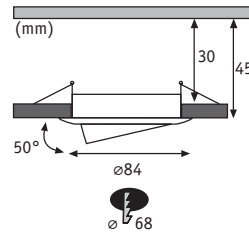

**Premium SmartCoin BLE Tunable**

A<sup>++</sup>-A

incl. 3×6 W  
3×570 lm, 2.000 - 2.700 K  
✕ 100°  
230/24 V, incl. -20 VA  
ø84 mm  
EAN 4000870 939369  
**939.36 new**



- ☞ Matt white ☞ Aluminium zinc
- ☞ Blanco mate ☞ Aluminio cinc
- ☞ Bianco opaco ☞ Alluminio zincato

**Premium SmartCoin BLE Tunable**

A<sup>++</sup>-A

incl. 3×5,5 W  
3×570 lm, 2.700 - 6.500 K  
✕ 100°  
230/24 V, incl. -20 VA  
ø84 mm  
EAN 4000870 939383  
**939.38 new**



- ☞ Matt white ☞ Aluminium zinc
- ☞ Blanco mate ☞ Aluminio cinc
- ☞ Bianco opaco ☞ Alluminio zincato

**Premium SmartCoin BLE RGBW**

A<sup>++</sup>-A

incl. 3×2 W  
3×100 lm  
✕ 103°  
230/24 V, incl. -20 VA  
ø84 mm  
EAN 4000870 939406  
**939.40 new**



- ☞ Matt white ☞ Aluminium zinc
- ☞ Blanco mate ☞ Aluminio cinc
- ☞ Bianco opaco ☞ Alluminio zincato



**Premium SmartCoin BLE Tunable**

A<sup>++</sup>-A

incl. 3×6 W  
3×570 lm, 2.000 - 2.700 K  
✕ 100°  
230/24 V, incl. -20 VA  
ø84 mm  
EAN 4000870 939376  
**939.37 new**



- ☞ Brushed iron ☞ Aluminium zinc
- ☞ Hierro mateado ☞ Aluminio cinc
- ☞ Ferro spazzolato ☞ Alluminio zincato

**Premium SmartCoin BLE Tunable**

A<sup>++</sup>-A

incl. 3×5,5 W  
3×570 lm, 2.700 - 6.500 K  
✕ 100°  
230/24 V, incl. -20 VA  
ø84 mm  
EAN 4000870 939390  
**939.39 new**



- ☞ Brushed iron ☞ Aluminium zinc
- ☞ Hierro mateado ☞ Aluminio cinc
- ☞ Ferro spazzolato ☞ Alluminio zincato

**Premium SmartCoin BLE RGBW**

A<sup>++</sup>-A

incl. 3×2 W  
3×100 lm  
✕ 103°  
230/24 V, incl. -20 VA  
ø84 mm  
EAN 4000870 939413  
**939.41 new**



- ☞ Brushed iron ☞ Aluminium zinc
- ☞ Hierro mateado ☞ Aluminio cinc
- ☞ Ferro spazzolato ☞ Alluminio zincato



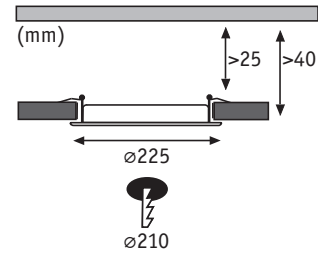

Smart Panel BLE	A++-A	Smart Panel BLE	A++-A	Smart Panel BLE	A++-A	Smart Panel BLE	A++-A
incl. 1x13,5 W 1.685 + 1.710 lm 2.700 - 6.500 K 230/24 V, incl. 15 VA ø225 mm EAN 4000870 500286 <b>500.28 new</b>		incl. 1x13,5 W 1.685 + 1.710 lm 2.700 - 6.500 K 230/24 V, incl. 15 VA ø225 mm EAN 4000870 500293 <b>500.29 new</b>		incl. 1x3,5 W 270 lm, 2.700 K 230/12 V, incl. 12 VA ø225 mm EAN 4000870 500262 <b>500.26 new</b>		incl. 1x3,5 W 270 lm, 2.700 K 230/12 V, incl. 12 VA ø225 mm EAN 4000870 500279 <b>500.27 new</b>	
<ul style="list-style-type: none"> <li>☞ Matt white </li> <li>☞ Blanco mate </li> <li>☞ Bianco opaco </li> </ul>		<ul style="list-style-type: none"> <li>☞ Brushed iron </li> <li>☞ Hierro mateado </li> <li>☞ Ferro spazzolato </li> </ul>		<ul style="list-style-type: none"> <li>☞ Matt white </li> <li>☞ Blanco mate </li> <li>☞ Bianco opaco </li> </ul>		<ul style="list-style-type: none"> <li>☞ Brushed iron </li> <li>☞ Hierro mateado </li> <li>☞ Ferro spazzolato </li> </ul>	

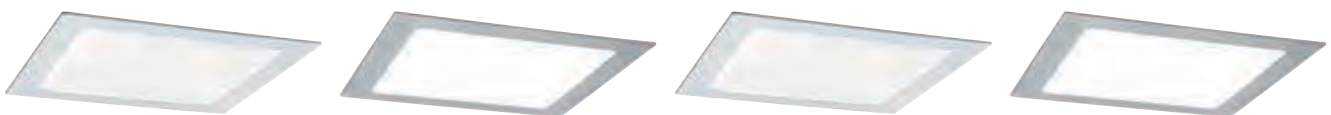
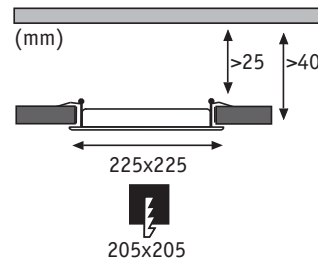
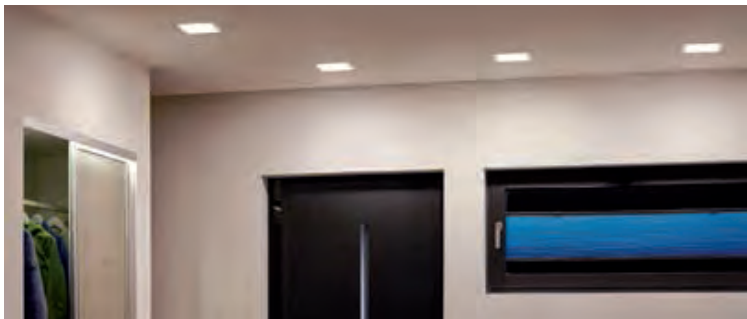

Smart Panel BLE	A++-A	Smart Panel BLE	A++-A	Smart Panel BLE	A++-A	Smart Panel BLE	A++-A
incl. 1x13,5 W 1.685 + 1.710 lm 2.700 - 6.500 K 230/24 V, incl. 15 VA ↔225 ↔225 mm EAN 4000870 500361 <b>500.36 new</b>		incl. 1x13,5 W 1.685 + 1.710 lm 2.700 - 6.500 K 230/24 V, incl. 15 VA ↔225 ↔225 mm EAN 4000870 500378 <b>500.37 new</b>		incl. 1x3,5 W 270 lm, 2.700 K 230/12 V, incl. 12 VA ↔225 ↔225 mm EAN 4000870 500347 <b>500.34 new</b>		incl. 1x3,5 W 270 lm, 2.700 K 230/12 V, incl. 12 VA ↔225 ↔225 mm EAN 4000870 500354 <b>500.35 new</b>	
<ul style="list-style-type: none"> <li>☞ Matt white </li> <li>☞ Blanco mate </li> <li>☞ Bianco opaco </li> </ul>		<ul style="list-style-type: none"> <li>☞ Brushed iron </li> <li>☞ Hierro mateado </li> <li>☞ Ferro spazzolato </li> </ul>		<ul style="list-style-type: none"> <li>☞ Matt white </li> <li>☞ Blanco mate </li> <li>☞ Bianco opaco </li> </ul>		<ul style="list-style-type: none"> <li>☞ Brushed iron </li> <li>☞ Hierro mateado </li> <li>☞ Ferro spazzolato </li> </ul>	

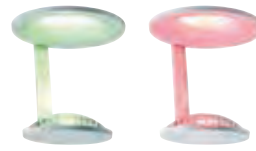

### Star Glint RGB BLE

incl. 1x2,5 W

58 lm

∠ 40°

230/12 V, incl. 4 VA

∅105 ø106 mm

EAN 4000870 935927

**935.92 new**

🌀 Matt white 🧱 Plastic

🌀 Blanco mate 🧱 Plástico

🌀 Bianco opaco 🧱 Plastica



### Opal Opal Opale



Boyn

	W	⚡	∅ mm	∓ mm	◻	lm	cd	∠	K	🕒	ON/OFF	📦	EAN	📌	
	9	E27	62	116	A*	650			2.700	25.000	50000	1	4000870 500118	✓	<b>new 500.11</b>
	9	E27	62	116	A*	650			2.700 - 6.500	25.000	50000	1	4000870 500125	✓	<b>new 500.12</b>
	9	E27	62	116	A	600			2.700	25.000	50000	1	4000870 500132	✓	<b>new 500.13</b>

### Clear Transparente Trasparente





Teen

	W	⚡	∅ mm	∓ mm	◻	lm/90°	cd	∠	K	🕒	ON/OFF	📦	EAN	📌	
	5	GU10	51	58	A*	300	845	35	2.700	25.000	50000	1	4000870 500149	✓	<b>new 500.14</b>
	5	GU10	51	58	A*	300	109	100	2.700 - 6.500	25.000	50000	1	4000870 500156	✓	<b>new 500.15</b>
	3	GU10	51	58	B	25	15	100	2.700	25.000	50000	1	4000870 500217	✓	<b>new 500.21</b>



**Gent Remote Control**

AAA/1,5V (Micro) × 2  
 ⌀18 ⇄55 ↗138 mm  
 EAN 4000870 500675  
**500.67 new**

- 🌀 Black  Plástico
- 🌀 Negro  Plástico
- 🌀 Nero  Plástica



**Cephei Switch**

max. 1.000 W  
 230 V  
 Ω max. 1.000 W  
 C max. 75 W, I max. 75 W  
 ⌀53 ⇄163 ↗60 mm  
 EAN 4000870 500439  
**500.43 new**

- 🌀 White/Grey  Plástico
- 🌀 Blanco/Gris  Plástico
- 🌀 Bianco/Grigio  Plástica



**Cephei Switch/Dimm**

max. 1.000 W  
 230 V  
 Ω max. 1.000 W  
 C max. 75 W,  
 ⌀53 ⇄163 ↗60 mm  
 EAN 4000870 500446  
**500.44 new**

- 🌀 White/Grey  Plástico
- 🌀 Blanco/Gris  Plástico
- 🌀 Bianco/Grigio  Plástica





- ↳ Matt white 田 Plastic
- ↳ Blanco mate 田 Plástico
- ↳ Bianco opaco 田 Plastica



**Cesena** A++-A

incl. 1x11 W  
850 lm, 2.700 - 6.500 K  
<math>\sphericalangle</math> 120°  
230 V  
ø170 mm  
EAN 4000870 500828  
**500.82 new**

LED, tunable white, Zigbee, Home



**Cesena** A++-A

incl. 1x13 W  
1.100 lm, 2.700 - 6.500 K  
<math>\sphericalangle</math> 120°  
230 V  
ø225 mm  
EAN 4000870 500835  
**500.83 new**

LED, tunable white, Zigbee, Home



**Cesena** A++-A

incl. 1x17 W  
1.400 lm, 2.700 - 6.500 K  
<math>\sphericalangle</math> 120°  
230 V  
ø300 mm  
EAN 4000870 500842  
**500.84 new**

LED, tunable white, Zigbee, Home



- ↳ Chrome matt 田 Plastic
- ↳ Cromo mate 田 Plástico
- ↳ Cromo opaco 田 Plastica



**Cesena** A++-A

incl. 1x11 W  
850 lm, 2.700 - 6.500 K  
<math>\sphericalangle</math> 120°  
230 V  
ø170 mm  
EAN 4000870 500859  
**500.85 new**

LED, RGB+W, Zigbee, Home



**Cesena** A++-A

incl. 1x13 W  
1.100 lm, 2.700 - 6.500 K  
<math>\sphericalangle</math> 120°  
230 V  
ø225 mm  
EAN 4000870 500866  
**500.86 new**

LED, RGB+W, Zigbee, Home



**Cesena** A++-A

incl. 1x17 W  
1.400 lm, 2.700 - 6.500 K  
<math>\sphericalangle</math> 120°  
230 V  
ø300 mm  
EAN 4000870 500873  
**500.87 new**

LED, RGB+W, Zigbee, Home



- ↳ Opal/Satin 田 Glass
- ↳ Opal/Satinado 田 Cristal
- ↳ Opale/Satinato 田 Vetro







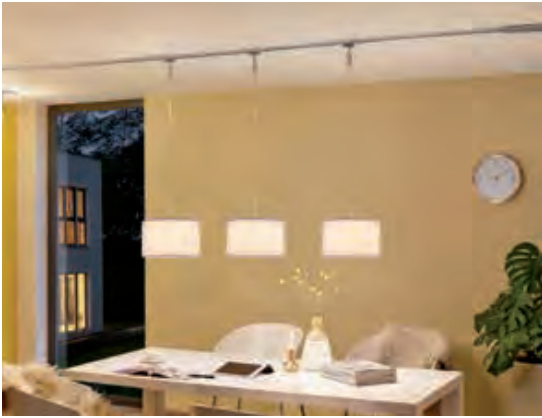

**Siegen** A++-E

incl. 7,5 W, E27, A++  
650 lm, 2.700 K  
230 V  
∅190 ∅200 mm  
EAN 4000870 501023  
**501.02 new**  
500.54

LED, RGB+W, On/Off, Zigbee, Home



-  White  Metal
-  Blanco  Metal
-  Bianco  Metallo

for URail  
□ 132-165



**URail Dimm/Switch Adapter**

230 V  
Ω max. 500 W, C max. 75 W  
⌀35 ↔155 ⌀56 mm  
EAN 4000870 500514  
**500.51 new**









**URail Dimm/Switch Adapter**

230 V  
Ω max. 500 W, C max. 75 W  
⌀35 ↔155 ⌀56 mm  
EAN 4000870 500507  
**500.50 new**



Tunable White



-  White  Plastic
-  Blanco  Plástico
-  Bianco  Plastica

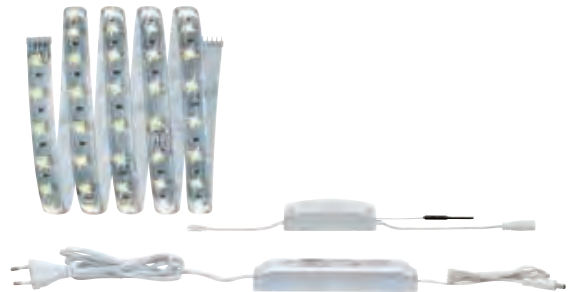







**Reflex LED Strip Set 3m Tunable**

incl. 1x20 W  
1.650-1.740 lm, 2.700 - 6.500 K  
∠ 120°  
230/24 V, incl. ⚡ 20 VA  
⌀3 mm ⌀12,5 mm ↔3 m  
EAN 4000870 500804  
**500.80 new**



RGB White

-  White  Plastic
-  Blanco  Plástico
-  Bianco  Plastica

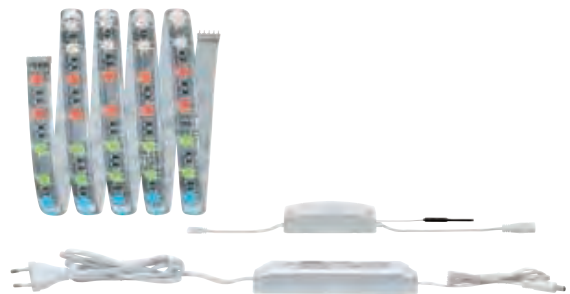

**Reflex LED Strip Set 3m RGBW**

incl. 1x20 W  
1.160-1.260 lm, 2.700 K  
∠ 120°  
230/24 V, incl. ⚡ 36 VA  
⌀3 mm ⌀12,5 mm ↔3 m  
EAN 4000870 500811  
**500.81 new**







- 🌀 White/Grey 🏠 Plástico
- 🌀 Blanco/Gris 🏠 Plástico
- 🌀 Bianco/Grigio 🏠 Plastica

for Strip  
☐ 191, 195



**YourLED Switch/Dimm Controller**

max. 60 W  
DC 12 V  
⌀28 ↔38 ↗95 mm  
EAN 4000870 500484  
**500.48** 🏠 **new**



for RGB Color  
☐ = 190, 194



**YourLED RGB Controller**

max. 60 W  
DC 12 V  
⌀28 ↔38 ↗95 mm  
EAN 4000870 500491  
**500.49** 🏠 **new**



- 🌀 White/Grey 🏠 Plástico
- 🌀 Blanco/Gris 🏠 Plástico
- 🌀 Bianco/Grigio 🏠 Plastica

for MaxLED  
☐ 176-182



**MaxLED Switch/Dimm Controller**

max. 144 W  
DC 24 V  
⌀28 ↔38 ↗95 mm  
EAN 4000870 500453  
**500.45** 🏠 **new**



for MaxLED  
☐ 185



max. 144 W  
DC 24 V  
⌀28 ↔38 ↗95 mm  
EAN 4000870 500460  
**500.46** 🏠 **new**



for MaxLED  
☐ 186

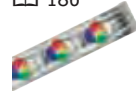

**MaxLED RGBW Controller**

max. 72 W  
DC 24 V  
⌀28 ↔38 ↗95 mm  
EAN 4000870 500477  
**500.47** 🏠 **new**





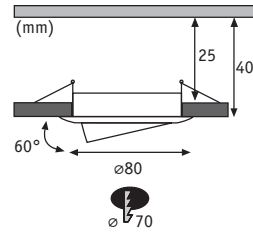











**Lens** A++-A

incl. 3x3,5W  
 3x180 lm, 2.700 - 6.500 K  
 ∠ 35°  
 230/12V, incl. -15 VA  
 ∅5 ∅80 mm  
 EAN 4000870 500644  
**500.64 new**





  
  
  





  
  
  





- 🔗 Matt white  Aluminium zinc
- 🔗 Blanco mate  Aluminio cinc
- 🔗 Bianco opaco  Alluminio zincato

**Lens** A++-A

incl. 3x4,8W  
 3x100 lm, 6.500 K  
 ∠ 35°  
 230/12V, incl. -15 VA  
 ∅5 ∅80 mm  
 EAN 4000870 500651  
**500.65 new**





  
  
  

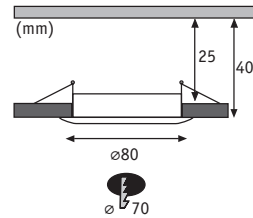



- 🔗 Matt white  Aluminium zinc
- 🔗 Blanco mate  Aluminio cinc
- 🔗 Bianco opaco  Alluminio zincato





**Lens** A++-A

incl. 3x4,8W  
 3x100 lm, 6.500 K  
 ∠ 35°  
 230/12V, incl. -15 VA  
 ∅2 ∅80 mm  
 EAN 4000870 500682  
**500.68 new**

- 🔗 Matt white  Aluminium zinc
- 🔗 Blanco mate  Aluminio cinc
- 🔗 Bianco opaco  Alluminio zincato



- 🔗 White 🏠 Aluminium/Plastic
- 🔗 Blanco 🏠 Aluminio/Plástico
- 🔗 Bianco 🏠 Alluminio/Plastica



**More**  
incl. 1x7W  
565 + 725 lm, 2.700 - 6.500 K  
230/24V, incl. ⚡ 12 VA  
ø120 mm  
EAN 4000870 500712  
**500.71 new**

**More**  
incl. 1x12W  
1.055 + 1.109 lm, 2.700 - 6.500 K  
230/24V, incl. ⚡ 15 VA  
ø170 mm  
EAN 4000870 500729  
**500.72 new**

**More**  
incl. 1x18W  
1.520 + 2.007 lm, 2.700 - 6.500 K  
230/24V, incl. ⚡ 20 VA  
ø225 mm  
EAN 4000870 500736  
**500.73 new**

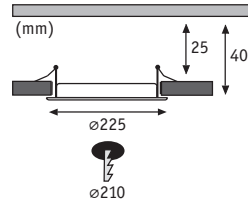
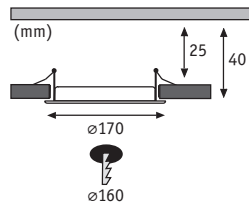
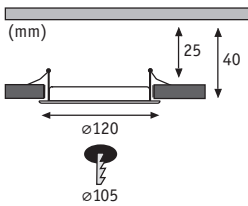

🔗 Opal Opal Opale

LED 🏠 Home

Soret

W	⚡	ø mm	↑ mm	⏏	lm	cd	⚡	K	🕒	ON/OFF ⏏	📦	EAN	📦
8,5	E27	60	120	A*	650			2.700	25.000	50000	10	4000870 500521	new 500.52
8,5	E27	60	120	A*	650			2.700 - 6.500	25.000	50000	10	4000870 500538	new 500.53
7,5	E27	60	120	A*	650			2.700	25.000	50000	10	4000870 500545	new 500.54



🔗 Clear Transparente Trasparente

LED 🏠 Home

Gatria

W	⚡	ø mm	↑ mm	⏏	lm	cd	⚡	K	🕒	ON/OFF ⏏	📦	EAN	📦
4,8	GU10	50	55	A*	350		36	2.700	25.000	50000	20	4000870 500613	new 500.61
4,8	GU10	50	55	A*	350		36	2.700 - 6.500	25.000	50000	20	4000870 500620	new 500.62



🔗 Opal Opal Opale

LED 🏠 Home

Candela

W	⚡	ø mm	↑ mm	⏏	lm	cd	⚡	K	🕒	ON/OFF ⏏	📦	EAN	📦
4,5	E14	37	115	A*	350			2.700	25.000	50000	15	4000870 500552	new 500.55
4,5	E14	37	115	A*	350			2.700 - 6.500	25.000	50000	15	4000870 500569	new 500.56



**Smart Friends-compatible**

With Smart Friends you can benefit from a future-proof, expandable system with four compatible German quality manufacturers:

- ▶ Security technology and outdoor WLAN camera by ABUS
- ▶ ZigBee and Bluetooth interior luminaires by Paulmann
- ▶ Drive technology for roller shutters and garage doors or Heating thermostats by Schellenberg
- ▶ Sensor technology and luminaires by STEINEL

You can use all products individually, you can link them up with each other and also automate operations. All of the products are controlled using the Smart Friends app on your smartphone or tablet PC.

**Compatible con Smart Friends**

Beneficiarse con Smart Friends de un sistema ampliable preparado para el futuro de cuatro fabricantes de calidad alemanes compatibles entre ellos:

- ▶ Tecnología de seguridad y cámara exterior WLAN de ABUS
- ▶ Luminarias interiores ZigBee y Bluetooth de Paulmann
- ▶ Técnica de accionamiento para persianas y puertas de garaje o Termostatos de calefacción de Schellenberg
- ▶ Tecnología de sensores y luminarias de STEINEL

Puede utilizar todos los productos individualmente o enlazarlos y, además, es posible automatizar acciones. El control de todos los productos se realiza a través de la aplicación Smart Friends en el smartphone o la tableta.

**Compatibilità con Smart Friends**

Con Smart Friends approfittate di un sistema, ampliabile e proteso verso il futuro, di quattro produttori tedeschi di elevata qualità compatibili fra loro:

- ▶ Tecnica di sicurezza e telecamera esterna WLAN di ABUS
- ▶ Apparecchi per interni ZigBee e Bluetooth di Paulmann
- ▶ Tecnica motoristica per tapparelle e porte garage o Termostati degli impianti di riscaldamento di Schellenberg
- ▶ Tecnica sensoristica e apparecchi di STEINEL

È possibile utilizzare tutti i prodotti singolarmente, collegarli fra loro e automatizzarne le attività. Il comando di tutti i prodotti ha luogo tramite la app Smart Friends su smartphone o tablet.



**Smart Friends Box**

30 ⇄ 140 ⇄ 140 mm  
 EAN 4000870 500668  
**500.66 new**

- 🎨 White 🧱 Plastic
- 🎨 Blanco 🧱 Plástico
- 🎨 Bianco 🧱 Plastica





Your house frightens off burglars automatically!

¡Su casa ahuyenta a los ladrones automáticamente!

Gli intrusi vengono spaventati automaticamente dall'impianto domotico!



Let your house wake you up!

¡Deje que le despierte su casa!

Lasciatevi svegliare dalla vostra casa!



Create a cosy atmosphere from the comfort of your sofa!

¡Cree un ambiente acogedor desde su propio sofá!

Create un'atmosfera rilassante comodamente dal vostro divano!



Your house is expecting you when you come home in the evening!

¡Cuando vuelve por la tarde, su casa ya le está esperando!

Per il rientro serale troverete già la vostra casa ad aspettarvi!



Smart Friends combines solutions from the fields of light, security, heating control and drive technology.

Smart Friends reúne soluciones de los ámbitos de luz, seguridad, control de calefacción y técnica de accionamiento.

Smart Friends riunisce soluzioni dai settori luce, sicurezza, comando del riscaldamento e tecnica motoristica.



**Your data are safe!**

With Smart Friends, data protection has top priority. Smart Friends guarantees you maximum protection of your data thanks to local data storage in the box – without any data whatsoever in the cloud.

**¡Sus datos están a salvo!**

Con Smart Friends, la protección de datos es prioritaria. Smart Friends le garantiza la máxima protección de sus datos gracias a su almacenamiento local en la caja; no se guarda ningún tipo de datos en la nube.



**I vostri dati sono al sicuro!**

Con Smart Friends la protezione dei dati è al primo posto. Smart Friends vi garantisce la massima protezione dei dati grazie alla loro memorizzazione locale sulla box, del tutto senza dati in cloud.

Lighting control / transformers

Control de luz / Transformadores

Controllo dell'illuminazione / Trasformatori



**VDE Disc Transformer 230/12V**



- ▶ Disc transformers fit through round boreholes
- ▶ Can be dimmed with all dimmers (phases cut on/off)
- ▶ Los disc-trafos se encajan a través de agujeros circulares
- ▶ Regulable con todos los reguladores (de corte o inversión de fases)
- ▶ I trasformatori Disc si inseriscono in fori circolari
- ▶ Intensità regolabile con tutti i dimmer (a ritardo di fase e ad anticipo di fase)



**230/12 V, 70 VA**  
 max. 20-70 W  
 ⌀23 ⌀55 mm  
 EAN 4000870 977286  
**977.28**



**230/12 V, 105 VA**  
 max. 35-105 W  
 ⌀25 ⌀75 mm  
 EAN 4000870 977293  
**977.29**



**VDE Mipro Transformer 230/12V**



- ▶ Mipro transformers are designed for compact dimensions; they fit in the smallest installation spaces
- ▶ Ideal for recessed luminaires
- ▶ Can be used at an ambient temperature of up to 50°
- ▶ Can be dimmed with all dimmers (phases cut on/off)
- ▶ Los mipro-trafos han sido diseñados para las menores dimensiones y caben en los espacios de montaje más reducidos
- ▶ Ideal para luces empotradas
- ▶ Utilizable hasta 50° de temperatura ambiente
- ▶ Regulable con todos los reguladores (de corte o inversión de fases)
- ▶ I trasformatori Mipro sono concepiti con dimensioni minime e possono essere montati in spazi ridottissimi
- ▶ Ideale per luci da incasso
- ▶ Per temperature ambiente fino a 50°
- ▶ Intensità regolabile con tutti i dimmer (a ritardo di fase e ad anticipo di fase)



**230/12 V, 70 VA**  
 max. 20-70 W  
 ⌀23 ⇄36 ⌀127 mm  
 EAN 4000870 977514  
**977.51**



**230/12 V, 105 VA**  
 max. 35-105 W  
 ⌀30 ⇄38 ⌀137 mm  
 EAN 4000870 977538  
**977.53**





### VDE Flat Transformer 230/12V



- ▶ Flat transformers have an installation height of only 24 mm
- ▶ Problem solver for slightly suspended ceilings
- ▶ Ideal for mirror and gallery lighting and in furniture
- ▶ Can be dimmed with all dimmers (phases cut on/off)
- ▶ Los flat-trafos sobresalen sólo 24 mm
- ▶ Exentos de problemas incluso en techos de baja altura
- ▶ Ideal para luces de espejos, galerías y muebles
- ▶ Regulable con todos los reguladores (de corte o inversión de fases)
- ▶ I trasformatori Flat hanno un'altezza di soli 24 mm
- ▶ Soluzione ai problemi di spazi ridotti nei controsoffitti
- ▶ Ideale per specchi, quadri e integrazione nei mobili
- ▶ Intensità regolabile con tutti i dimmer (a ritardo di fase e ad anticipo di fase)



#### 230/12V, 70 VA

max. 20-70 W  
 ⌀24 ⇄ 50 ⌀147 mm  
 EAN 4000870 977811  
**977.81**

#### 230/12V, 105 VA

max. 35-105 W  
 ⌀24 ⇄ 50 ⌀147 mm  
 EAN 4000870 977828  
**977.82**



### VDE Profi Transformer 230/12V



- ▶ Can be used at an ambient temperature of up to 50°
- ▶ Suitable for a low minimum load of 10 W
- ▶ Can be dimmed with all dimmers (phases cut on/off)
- ▶ Utilizable hasta 50 ° de temperatura ambiente
- ▶ Apto para baja carga mínima de 10 W
- ▶ Regulable con todos los reguladores (de corte o inversión de fases)
- ▶ Per temperatura ambiente fino a 50 °
- ▶ Adatto per carico minimo ridotto 10 W
- ▶ Intensità regolabile con tutti i dimmer (a ritardo di fase e ad anticipo di fase)



#### 230/12V, 50 VA

max. 10-50 W  
 ⌀19 ⇄ 36 ⌀77 mm  
 EAN 4000870 977361  
**977.36**



Smart Home ☞ = 386-403

Comfortably control your lighting with your smart phone or remote control, using the additional products from the Smart Home chapter (P. 386-403).

Controle su luz cómodamente mediante el smartphone o el mando a distancia con los productos complementarios del capítulo Smart Home (p. 386-403)

Comandate le vostre luci comodamente utilizzando lo smartphone o il telecomando con i prodotti supplementari del capitolo Smart Home (pag. 386-403).

**VDE Profi Transformer 230/12V**



- |   |  |  |
|---|--|--|
| <ul style="list-style-type: none"> <li>▶ Doubled primary connection for several transformers in a single switch</li> <li>▶ Several secondary terminal pairs</li> <li>▶ Max. 50 ° ambient temperature</li> <li>▶ Suitable for NYM cable</li> <li>▶ Captive strain relief and cap</li> <li>▶ Middle outlet</li> <li>▶ Can be dimmed with all dimmers (phases cut on/off)</li> </ul> | <ul style="list-style-type: none"> <li>▶ Doble conexión de primario para varios transformadores en un circuito</li> <li>▶ Varios pares de bornes de secundario</li> <li>▶ Hasta 50 ° de temperatura ambiente</li> <li>▶ Aptos para cable NYM</li> <li>▶ Capuchón y dispositivo antiaflojamiento imperdible</li> <li>▶ Salida central</li> <li>▶ Regulable con todos los reguladores (de corte o inversión de fases)</li> </ul> | <ul style="list-style-type: none"> <li>▶ Doppia connessione primaria per più trasformatori in un circuito</li> <li>▶ Più coppie di morsetti per secondario</li> <li>▶ Per temperature ambiente fino a 50 °</li> <li>▶ Adatto per cavi NYM</li> <li>▶ Scarico della trazione e coperchio imperdibili</li> <li>▶ Uscita centrale</li> <li>▶ Intensità regolabile con tutti i dimmer (a ritardo di fase e ad anticipo di fase)</li> </ul> |
|---|--|--|



**230/12V, 80 VA**  
 max. 20-80 W  
 ⌀27 ↔39 ⌀161 mm  
 EAN 4000870 977712  
**977.71**

**230/12V, 105 VA**  
 max. 35-105 W  
 ⌀27 ↔39 ⌀161 mm  
 EAN 4000870 977019  
**977.01**



**230/12V, 150 VA**  
 max. 50-150 W  
 ⌀40 ↔48 ⌀190 mm  
 EAN 4000870 977156  
**977.15**



**230/12V, 200 VA**  
 max. 100-200 W  
 ⌀44 ↔51 ⌀222 mm  
 EAN 4000870 977200  
**977.20**

**230/12V, 250 VA**  
 max. 100-250 W  
 ⌀44 ↔51 ⌀222 mm  
 EAN 4000870 977255  
**977.25**



**Halo + LED Trafo 230/12V AC**



- |   |  |  |
|---|--|--|
| <ul style="list-style-type: none"> <li>▶ For halogen and LED</li> <li>▶ No minimum load</li> <li>▶ Can be dimmed with reverse phase control dimmer</li> </ul> | <ul style="list-style-type: none"> <li>▶ Para halógeno y LED</li> <li>▶ Sin carga mínima</li> <li>▶ Intensidad regulable con reguladores de sección de fase</li> </ul> | <ul style="list-style-type: none"> <li>▶ Per Halogen e LED</li> <li>▶ Senza carico minimo</li> <li>▶ Intensità regolabile con dimmer a fase interrotta finale</li> </ul> |
|---|--|--|



**230/12V, 50 VA**  
 max. 0-50 W  
 ⌀28 ↔44 ⌀127 mm  
 EAN 4000870 977620  
**977.62** new

**230/12V, 65 VA**  
 max. 0-65 W  
 ⌀28 ↔44 ⌀127 mm  
 EAN 4000870 977675  
**977.67**



LED = 416-418  
 977.62 max. 30W  
 977.67 max. 40W



12V = 459-452  
 977.62 max. 50W  
 977.67 max. 65W



### Spice Transformer 230/12V



#### 230/12V, 300 VA

max. 300 W  
 ⌀80 ⇄205 ⚡205 mm  
 EAN 4000870 972786  
**972.78**

- 🔩 Chrome matt 🏠 Metal
- 🔩 Cromo mate 🏠 Metal
- 🔩 Cromo opaco 🏠 Metallo

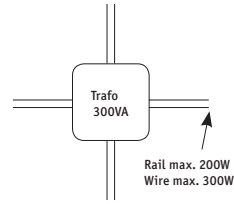

### Toroidal Decorative Transformer 230/12V



- 🔩 Chrome 🏠 Plastic
- 🔩 Cromo 🏠 Plástico
- 🔩 Cromo 🏠 Plastica

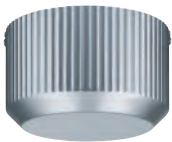

#### 230/12V, 80 VA

max. 80 W  
 ⌀86 ø145 mm  
 EAN 4000870 979327  
**979.32**

#### 230/12V, 105 VA

max. 105 W  
 ⌀86 ø145 mm  
 EAN 4000870 979419  
**979.41**

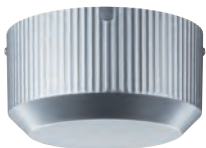

#### 230/12V, 150 VA

max. 150 W  
 ⌀92 ø174 mm  
 EAN 4000870 979433  
**979.43**

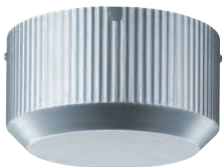

#### 230/12V, 200 VA

max. 200 W  
 ⌀100 ø189 mm  
 EAN 4000870 979457  
**979.45**

#### 230/12V, 300 VA

max. 300 W  
 ⌀100 ø189 mm  
 EAN 4000870 979464  
**979.46**



### Power Supply 230/12V DC

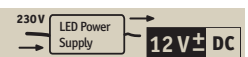

- ▶ For a wide range of system applications
- ▶ For YourLED and YourLED ECO

- ▶ Para múltiples aplicaciones
- ▶ Para YourLED y YourLED ECO

- ▶ Per numerose soluzioni del sistema yourLED
- ▶ Per YourLED e YourLED ECO



#### 230/12V, 15 VA

max. 15 W  
 ⌀18 ⇄125 ⚡40 mm  
 EAN 4000870 701997  
**701.99** 📦



#### 230/12V, 48 VA

max. 48 W  
 ⌀40 ⇄135 ⚡55 mm  
 EAN 4000870 702000  
**702.00** 📦



for YourLED Strip  
 □ = 190-195



**Power Supply 60W 230/12V DC IP65**



- ▶ For a wide range of system applications
- ▶ For YourLED and YourLED ECO
- ▶ Especially suitable for use in damp rooms.
- ▶ Para múltiples aplicaciones
- ▶ Para YourLED y YourLED ECO
- ▶ Especialmente indicado para espacios húmedos
- ▶ Per numerose soluzioni del sistema yourLED
- ▶ Per YourLED e YourLED ECO
- ▶ Particolarmente indicato per l'impiego in ambienti umidi.



**230/12V, 60VA**  
 max. 60W  
 ⌀40 ⇄225 ↗60 mm  
 EAN 4000870 702017  
**702.01**



for YourLED Strip  
 □ = 190-195



**LED Power Supply 12W 230/12V DC**



- ▶ Driver are specially designed for LED operation
- ▶ 230 V 50 Hz / 12 V DC
- ▶ Las controladoras han sido específicamente diseñadas para el funcionamiento con LEDs
- ▶ 230 V 50 Hz / 12 V DC
- ▶ Driver concepiti appositamente per il funzionamento di LED
- ▶ 230 V 50 Hz / 12 V DC



**230/12V, 12VA**  
 max. 12W  
 ⌀19 ⇄39 ↗122 mm  
 EAN 4000870 987544  
**987.54**

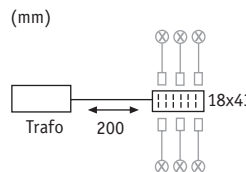

**Power Supply 230/24V DC**



- ▶ For a wide range of system applications
- ▶ For MaxLED
- ▶ Para múltiples aplicaciones
- ▶ Para MaxLED
- ▶ Per numerose soluzioni del sistema yourLED
- ▶ Per MaxLED



**230/24V, 36VA**  
 max. 36W  
 ⌀24 ⇄166 ↗52 mm  
 EAN 4000870 708231  
**708.23** **new**



**230/24V, 60VA**  
 max. 60W  
 ⌀35 ⇄175 ↗54 mm  
 EAN 4000870 708248  
**708.24** **new**



for MaxLED Strip  
 □ = 174-186



for SmartHome  
 □ = 386-403



**LED Driver 350mA const. 10W max. 35V DC**



- ▶ Driver are specially designed for LED operation
- ▶ 350 mA constant current

- ▶ Las controladoras han sido específicamente diseñadas para el funcionamiento con LEDs
- ▶ 350 mA de corriente constante

- ▶ Driver concepiti appositamente per il funzionamento di LED
- ▶ Corrente costante a 350 mA



**230V, 10VA**  
 max. 10W  
 ⌀30 ⇄50 ↗110 mm  
 EAN 4000870 975381  
**975.38**

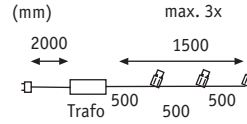

**LED-Driver Disc 350mA 9W max. 34V DC**



- ▶ Driver are specially designed for LED operation
- ▶ 350 mA constant current

- ▶ Las controladoras han sido específicamente diseñadas para el funcionamiento con LEDs
- ▶ 350 mA de corriente constante

- ▶ Driver concepiti appositamente per il funzionamento di LED
- ▶ Corrente costante a 350 mA



**230V, 9VA**  
 max. 9W  
 ⌀24 ø52 mm  
 EAN 4000870 977385  
**977.38**



**LED-Driver Disc 700mA 12W max. 16V**



- ▶ Driver are specially designed for LED operation
- ▶ 700 mA constant current

- ▶ Las controladoras han sido específicamente diseñadas para el funcionamiento con LEDs
- ▶ 700 mA de corriente constante

- ▶ Driver concepiti appositamente per il funzionamento di LED
- ▶ Corrente costante a 700 mA



**230V, 12VA**  
 max. 12W  
 ⌀24 ø52 mm  
 EAN 4000870 977378  
**977.37**



**LED Driver 700mA 3W max. 5V DC**



- ▶ Driver are specially designed for LED operation
- ▶ 700 mA constant current

- ▶ Las controladoras han sido específicamente diseñadas para el funcionamiento con LEDs
- ▶ 700 mA de corriente constante

- ▶ Driver concepiti appositamente per il funzionamento di LED
- ▶ Corrente costante a 700 mA



**230V, 3VA**  
 max. 3W  
 ⌀22 ⇄28 ↗38 mm  
 EAN 4000870 977033  
**977.03**



**LED Driver dimmable 350 mA**



- ▶ Driver are specially designed for LED operation
- ▶ 350 mA constant current
- ▶ Can be dimmed with all dimmers (phases cut on/off)
- ▶ Las controladoras han sido específicamente diseñadas para el funcionamiento con LEDs
- ▶ 350 mA de corriente constante
- ▶ Regulable con todos los reguladores (de corte o inversión de fases)
- ▶ Driver concepiti appositamente per il funzionamento di LED
- ▶ Corrente costante a 350 mA
- ▶ Intensità regolabile con tutti i dimmer (a ritardo di fase e ad anticipo di fase)



**230V, 7-9 VA**  
 max. 9 W  
 ⌀24 ⇄41 ↗119 mm  
 EAN 4000870 977231  
**977.23**

**230V, 8-12 VA**  
 max. 12 W  
 ⌀24 ⇄41 ↗119 mm  
 EAN 4000870 977248  
**977.24**

**230V, 10-15 VA**  
 max. 15 W  
 ⌀24 ⇄41 ↗119 mm  
 EAN 4000870 977262  
**977.26**



**230V, 15-20 VA**  
 max. 20 W  
 ⌀26 ⇄43 ↗143 mm  
 EAN 4000870 977606  
**977.60**



**LED Driver dimmable 700 mA**



- ▶ Driver are specially designed for LED operation
- ▶ 700 mA constant current
- ▶ Can be dimmed with all dimmers (phases cut on/off)
- ▶ Las controladoras han sido específicamente diseñadas para el funcionamiento con LEDs
- ▶ 700 mA de corriente constante
- ▶ Regulable con todos los reguladores (de corte o inversión de fases)
- ▶ Driver concepiti appositamente per il funzionamento di LED
- ▶ Corrente costante a 700 mA
- ▶ Intensità regolabile con tutti i dimmer (a ritardo di fase e ad anticipo di fase)



**230V, 7-9 VA**  
 max. 9 W  
 ⌀24 ⇄41 ↗119 mm  
 EAN 4000870 977279  
**977.27**

**230V, 9-12 VA**  
 max. 12 W  
 ⌀24 ⇄41 ↗119 mm  
 EAN 4000870 977392  
**977.39**



**230V, 13-18 VA**  
 max. 18 W  
 ⌀26 ⇄43 ↗143 mm  
 EAN 4000870 977347  
**977.34**

**230V, 18-25 VA**  
 max. 25 W  
 ⌀26 ⇄43 ↗143 mm  
 EAN 4000870 977330  
**977.33**

**230V, 21-30 VA**  
 max. 30 W  
 ⌀26 ⇄43 ↗143 mm  
 EAN 4000870 977323  
**977.32**





**LED Driver 350 mA**

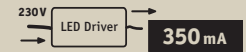

**230 V, 1-4 VA**  
 max. 4 W  
 ⌀19 ⇄39 ↗80 mm  
 EAN 4000870 977446  
**977.44** **new**



**230 V, 3,5-7 VA**  
 max. 7 W  
 ⌀23 ⇄38 ↗80 mm  
 EAN 4000870 977453  
**977.45** **new**



**230 V, 7-15 VA**  
 max. 15 W  
 ⌀18 ⇄49 ↗103 mm  
 EAN 4000870 977439  
**977.43** **new**



**230 V, 14-22 VA**  
 max. 22 W  
 ⌀22 ⇄43 ↗126 mm  
 EAN 4000870 977460  
**977.46** **new**



**LED Driver 700 mA**



**230 V, 2-7 VA**  
 max. 7 W  
 ⌀18 ⇄38 ↗79 mm  
 EAN 4000870 977477  
**977.47** **new**



**230 V, 6-15 VA**  
 max. 15 W  
 ⌀18 ⇄39 ↗122 mm  
 EAN 4000870 977484  
**977.48** **new**



**230 V, 11-22 VA**  
 max. 22 W  
 ⌀22 ⇄43 ↗126 mm  
 EAN 4000870 977491  
**977.49** **new**



**230 V, 19,5-42 VA**  
 max. 42 W  
 ⌀30 ⇄43 ↗137 mm  
 EAN 4000870 977507  
**977.50** **new**



**LED Transformer IP44 230/12V AC**



- ▶ 230 V 50 Hz / 12 V AC 50 Hz
- ▶ Ideal for the outdoors, IP44
- ▶ 230 V 50 Hz / 12 V AC 50 Hz
- ▶ Ideal para exteriores, IP44
- ▶ 230 V 50 Hz / 12 V AC 50 Hz
- ▶ Ideale per gli esterni, IP44



**230/12V, 6VA**

max. 6 W  
 ∅50 ⇔70 ↗60 mm  
 EAN 4000870 987599  
**987.59**

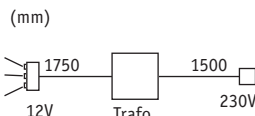

max. 6x  
**988.69**



max. 6x  
**988.71**



Connector  
**988.46**



max. 3x  
**988.77**



max. 3x  
**988.76**



**988.45**



**937.50**



**LED Transformer 230/12V AC**

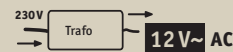

- ▶ 230 V 50 Hz / 12 V AC 50 Hz
- ▶ 230 V 50 Hz / 12 V AC 50 Hz
- ▶ 230 V 50 Hz / 12 V AC 50 Hz



**230/12V, 20VA**

max. 20 W  
 ∅53 ⇔58 ↗87 mm  
 EAN 4000870 977590  
**977.59**

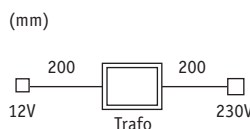

LED □ = 416-418



### Outdoorbox IP65



↕102 ↔146 ↗240 mm  
EAN 4000870 988473

**988.47**

- 🔗 Black 📦 Aluminium
- 🔗 Negro 📦 Aluminio
- 🔗 Nero 📦 Alluminio

Ⓜ  
IP65



### PIR-Sensor 230V

- ▶ Proximity switch for switching on and off the LED stripes and other products
- ▶ Max. 75 W (magnetic transformers)
- ▶ Max. 60 W (electronic load)
- ▶ Max. 250 W (light bulbs)
- ▶ Interruptor de proximidad para encender/apagar regletas LED-stripes y otros productos
- ▶ Máx. 75 W (transformadores magnéticos)
- ▶ Máx. 60 W (carga electrónica)
- ▶ Máx. 250 W (lámparas incandescentes)
- ▶ Interrupteur de proximité Marche/Arrêt des rubans LED et autres produits
- ▶ Max. 75 W (trasformatori magnetici)
- ▶ Max. 60 W (carico elettronico)
- ▶ Max. 250 W (lampadine a incandescenza)



#### PIR-Sensor 230V

max. 60 W  
230 V  
↕19 ø17,5 ↔85 ↗36 mm  
EAN 4000870 704516

**704.51**

- 🔗 White 📦 Plastic
- 🔗 Blanco 📦 Plástico
- 🔗 Bianco 📦 Plastica

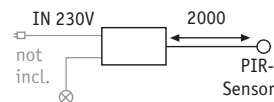
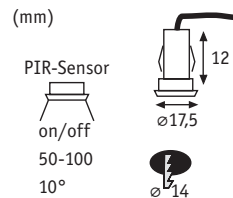

# LED bulbs

## Medio de iluminación LED

## Mezzi d'illuminazione a LED

- 416 LED/Coin
- 417 LED/12V
- 420 LED/230V



### Lumen comparison

### Comparativa de lúmenes

### Comparazione luminosità

Lighting technology  
Luminotecnica  
Soluzione illuminotecnica

(Incandescent) lamp watts  
Lámpara (incandescente) vatios  
Lampadina (a incandescenza) Watt

LED brightness in lumen  
Luminosidad LED en lúmenes  
Luminosità LED in Lumen

Omnidirectional lamps  
Proyectores omnidireccionales  
Luci omnidirezionali

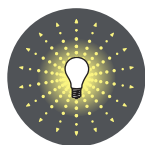

Classic incandescent light bulb Lámpara incandescente clásica Lampadina a incandescenza classica <b>E14, E27, GU10</b>		15 W	140 lm
		25 W	250 lm
		40 W	470 lm
		60 W	806 lm
		75 W	1055 lm
		100 W	1521 lm
Halogen 230V <b>G9, E27, R7s</b>		25 W	250 lm
		40 W	470 lm
		60 W	806 lm
Halogen 12V <b>G4, GY6,35</b>		5 W	45 lm
		10 W	90 lm
		20 W	190 lm
		35 W	390 lm
		50 W	630 lm

Reflector lamps  
Lámparas con reflector  
Riflettori

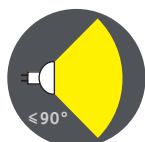

Halogen 230V <b>E14, E27, GU10</b>		25 W	125 lm
		35 W	200 lm
		50 W	300 lm
Halogen 12V <b>GU4, GU5,3</b>		10 W	80 lm/90 lm (GU4/GU5,3)
		20 W	160 lm/180 lm (GU4/GU5,3)
		35 W	300 lm
		50 W	540 lm



W	⊖	∅ mm	↑ mm	⬠	lm	lm/M	⚡	K	🕒	ON/OFF	📦	EAN	✓	
6,8		49,5	30	A	544	544	38	2.700	30.000	15000	1	4000870 939482	✓	<b>new 939.48</b>



🔗 Clear Transparente Trasparente

W	⊖	∅ mm	↑ mm	⬠	lm /90°	lm/M	⚡	K	🕒	ON/OFF	📦	EAN	✓	
6,8		49,5	40	A*	535	535	110	2.700	30.000	15000	1	4000870 938171	✓	<b>938.17</b>

LED Coin 51mm

🔗 Satin Satinado Satinato



W	⊖	∅ mm	↑ mm	⬠	lm /90°	lm/M	⚡	K	🕒	ON/OFF	📦	EAN	✓	
6,8		49,5	40	A*	535	535	160	2.700	30.000	15000	1	4000870 938195	✓	<b>938.19</b>
6,8		49,5	40	A*	470	470	160	6.500	30.000	15000	1	4000870 938324	✓	<b>938.32</b>

LED Coin 51mm



🔗 Clear Transparente Trasparente

W	⊖	∅ mm	↑ mm	⬠	lm	lm/M	⚡	K	🕒	ON/OFF	📦	EAN	✓	
7		49,5	35	A*	410	482	110	2.700	30.000	15000	1	4000870 938355	✓	<b>938.35</b>

LED Coin 51mm



🔗 Satin Satinado Satinato

W	⊖	∅ mm	↑ mm	⬠	lm /120°	lm/M	⚡	K	🕒	ON/OFF	📦	EAN	✓	
7		49,5	35	A	482	482	105	2.700	30.000	15000	1	4000870 938362	✓	<b>938.36</b>
7		49,5	35	A*	455	633	105	4.000	30.000	15000	1	4000870 938379	✓	<b>938.37</b>

LED Coin 51mm

🔗 Satin Satinado Satinato



W	⊖	∅ mm	↑ mm	⬠	lm	lm/M	⚡	K	🕒	ON/OFF	📦	EAN	✓	
6,8		50	30	A	592	592	120	2.700	30.000	15000	1	4000870 938843	✓	<b>new 938.84</b>
6,8		50	30	A	633	633	120	2.700	30.000	15000	1	4000870 938850	✓	<b>new 938.85</b>



## White Blanco Bianco

W	⚡	∅ mm	↑ mm	⬠	lm	cd	↘	K	🕒	ON/OFF	📦	EAN	📄	
1,3	G4	22	31	A+	90			2.700	15.000	50000	10	4000870 282878	✓	282.87



## White Blanco Bianco

W	⚡	∅ mm	↑ mm	⬠	lm	cd	↘	K	🕒	ON/OFF	📦	EAN	📄	
2,5	G4	30	42	A+	180			2.700	15.000	50000	10	4000870 282755	✓	282.75



## White Blanco Bianco

W	⚡	∅ mm	↑ mm	⬠	lm	cd	↘	K	🕒	ON/OFF	📦	EAN	📄	
1	G4	15	31	A+	85			3.000	10.000	40000	10	4000870 280911	✓	280.91



## Clear Transparente Trasparente

W	⚡	∅ mm	↑ mm	⬠	lm	cd	↘	K	🕒	ON/OFF	📦	EAN	📄	
2	G4	14	37	A+	140			2.700	15.000	50000	10	4000870 283363	✓	283.36

3 VA



## White Blanco Bianco

W	⚡	∅ mm	↑ mm	⬠	lm	cd	↘	K	🕒	ON/OFF	📦	EAN	📄	
2,5	G4	15	42	A+	170			2.700	15.000	50000	10	4000870 282762	✓	282.76



## White Blanco Bianco

W	⚡	∅ mm	↑ mm	⬠	lm	cd	↘	K	🕒	ON/OFF	📦	EAN	📄	
2,5	GY6,35	15	38	A+	170			2.700	15.000	50000	10	4000870 282779	✓	282.77



## Aluminium Aluminio Alluminio

W	⚡	∅ mm	↑ mm	⬠	lm /90°	cd	↘	K	🕒	ON/OFF	📦	EAN	📄	
4	GU4	35	40	A	200	550	30	2.700	15.000	50000	10	4000870 282601	✓	282.60

5 VA

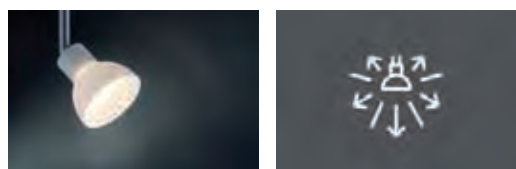

Maxiflood

## Soft opal Ópalo suave Opale tenue

W	⚡	∅ mm	↑ mm	⬠	lm	cd	↘	K	🕒	ON/OFF	📦	EAN	📄	
1,8	GU4	35	33	A+	100			2.700	15.000	50000	10	4000870 283295	✓	283.29

2 VA



## Aluminium Aluminio Alluminio

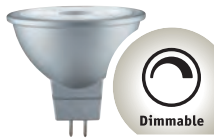

W	⊖	∅ mm	⇅ mm	◻	lm	cd	✂	K	⌚	ON/OFF	📦	EAN	☑	
4,5	GU5,3	51	46	A <sup>+</sup>	345	900	36	2.700	25.000	50000	10	4000870 284650	✓	new 284.65
5 VA														
6,5	GU5,3	51	46	A <sup>+</sup>	460	900	36	2.700	25.000	50000	10	4000870 284667	✓	new 284.66
7 VA														

## Aluminium Aluminio Alluminio



W	⊖	∅ mm	⇅ mm	◻	lm <sub>/90°</sub>	cd	✂	K	⌚	ON/OFF	📦	EAN	☑	
7,5	GU5,3	51	48	A	430	930	36	2.700	25.000	50000	10	4000870 283479	✓	283.47
8 VA														
6,5	GU5,3	51	48	A	340	900	36	2.700	25.000	50000	10	4000870 283462	✓	283.46
7 VA														

## Aluminium Aluminio Alluminio



W	⊖	∅ mm	⇅ mm	◻	lm <sub>/90°</sub>	cd	✂	K	⌚	ON/OFF	📦	EAN	☑	
7	GU5,3	51	48	A	420	1.200	35	2.700	25.000	50000	10	4000870 282564	✓	282.56
8 VA														

## Aluminium Aluminio Alluminio



W	⊖	∅ mm	⇅ mm	◻	lm <sub>/90°</sub>	cd	✂	K	⌚	ON/OFF	📦	EAN	☑	
4	GU5,3	51	45	A <sup>+</sup>	230	500	38	2.700	20.000	50000	7	4000870 283011	✓	283.01
5.5 VA														

## Aluminium Aluminio Alluminio



W	⊖	∅ mm	⇅ mm	◻	lm <sub>/90°</sub>	cd	✂	K	⌚	ON/OFF	📦	EAN	☑	
8	GU5,3	51	52	A	434	1.200	35	2.700	20.000	50000	10	4000870 282373	✓	282.37
9 VA														
8	GU5,3	51	52	A	470	1.100	35	6.500	20.000	50000	10	4000870 282489	✓	282.48
9 VA														

## Silver Plateado Argentó



W	⊖	∅ mm	⇅ mm	◻	lm <sub>/90°</sub>	cd	✂	K	⌚	ON/OFF	📦	EAN	☑	
1	GU5,3	51	45	A <sup>+</sup>	35	170	20	3.000	10.000	10000	10	4000870 280492	✓	280.49
1	GU5,3	51	45	A <sup>+</sup>	35	170	20	6.500	10.000	10000	10	4000870 280003	✓	280.00

## Blue Azul Blu



Blue Light



W	⊖	∅ mm	⇅ mm	◻	lm	cd	✂	K	⌚	ON/OFF	📦	EAN	☑	
3,5	GU5,3	51	52	B	40		25		20.000		10	4000870 282502	✓	282.50
4 VA														

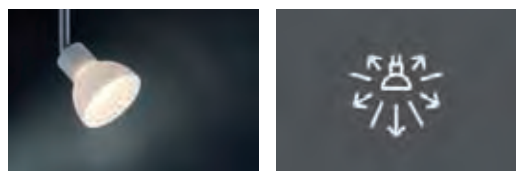

Maxiflood

Soft opal Ópalo suave Opale tenue

W	⚡	∅ mm	h mm	⬠	lm	cd	✂	K	⌚	ON/OFF	📦	EAN	✓	
3	GU5,3	51	45	A*	220			2.700	15.000	50000	10	4000870 283301	✓	283.30

4 VA



Hexa

Diamond Diamond Diamond

W	⚡	∅ mm	h mm	⬠	lm	cd	✂	K	⌚	ON/OFF	📦	EAN	✓	
3	GU5,3	45	50	A*	250			2.700	15.000	50000	1	4000870 283264	✓	283.26

4.5 VA



Quadro

Diamond Diamond Diamond

W	⚡	∅ mm	h mm	⬠	lm	cd	✂	K	⌚	ON/OFF	📦	EAN	✓	
3	GU5,3	37	50	A*	250			2.700	15.000	50000	1	4000870 283257	✓	283.25

4.5 VA





Clear Transparente Trasparente

W	⊖	∅ mm	↑ mm	⬠	lm	cd	⚡	K	⌚	ON/OFF	📦	EAN	☑	
1,5	G9	18	45	A+	100			2.700	15.000	50000	10	4000870 281796	☑	281.79

Clear Transparente Trasparente



W	⊖	∅ mm	↑ mm	⬠	lm	cd	⚡	K	⌚	ON/OFF	📦	EAN	☑	
2x1,5	G9	14	46	A+	90			2.700	25.000	50000	15	4000870 282892	☑	282.89
1,5	G9	14	46	A+	90			2.700	25.000	50000	15	4000870 283424	☑	283.42

Clear Transparente Trasparente



W	⊖	∅ mm	↑ mm	⬠	lm	cd	⚡	K	⌚	ON/OFF	📦	EAN	☑	
2	G9	18	54	A+	180			2.700	15.000	50000	10	4000870 282274	☑	282.27

Opal Opal Opale



W	⊖	∅ mm	↑ mm	⬠	lm	cd	⚡	K	⌚	ON/OFF	📦	EAN	☑	
2x2,4	G9	18	54	A+	180			2.700	25.000	50000	15	4000870 282908	☑	282.90
2,4	G9	18	54	A+	180			2.700	25.000	50000	15	4000870 283431	☑	283.43

W	⊖	∅ mm	↑ mm	⬠	lm	cd	⚡	K	⌚	ON/OFF	📦	EAN	☑	
3x2,4	G9	17	54	A+	210			2.700	20.000	50000	1	4000870 285107	☑	new 285.10
2,4	G9	17	54	A+	210			2.700	20.000	50000	1	4000870 285091	☑	new 285.09



Clear Transparente Trasparente

W	⊖	∅ mm	↑ mm	⬠	lm	cd	⚡	K	⌚	ON/OFF	📦	EAN	☑	
2,2	G9	15	50	A+	200			2.700	20.000	50000	10	4000870 283387	☑	283.38



Clear Transparente Trasparente

W	⊖	∅ mm	↑ mm	⬠	lm	cd	⚡	K	⌚	ON/OFF	📦	EAN	☑	
3	G9	16	50	A+	300			2.700	15.000		10	4000870 284469	☑	new 284.46



Clear Transparente Trasparente

W	⊖	∅ mm	↑ mm	⬠	lm	cd	⚡	K	⌚	ON/OFF	📦	EAN	☑	
3	G9	30	75	A+	250			3.000	15.000	50000	10	4000870 281123	☑	281.12



### Clear Transparente Trasparente

W	⊖	∅ mm	↑ mm	⬠	lm	cd	✂	K	⌚	ON/OFF	📦	EAN	☑	
3	GU10	30	70	A <sup>+</sup>	250			2.700	15.000	100000	10	4000870 282243	☑	282.24



### Satin Satinado Satinato

W	⊖	∅ mm	↑ mm	⬠	lm	cd	✂	K	⌚	ON/OFF	📦	EAN	☑	
5	GU10	30	125	A <sup>+</sup>	490			2.700	15.000	50000	10	4000870 284186	☑	284.18

Deco Pipe



W	⊖	∅ mm	↑ mm	⬠	lm /90°	cd	✂	K	⌚	ON/OFF	📦	EAN	☑	
5,5	GU10	51	54	A <sup>+</sup>	345	800	36	2.700	25.000	50000	10	4000870 284636	☑	new 284.63
7	GU10	51	54	A <sup>+</sup>	460	900	36	2.700	25.000	50000	10	4000870 284643	☑	new 284.64

R, C



### Aluminium Aluminio Alluminio

W	⊖	∅ mm	↑ mm	⬠	lm /90°	cd	✂	K	⌚	ON/OFF	📦	EAN	☑	
7	GU10	51	58	A	360	920	36	2.700	25.000	50000	10	4000870 283448	☑	283.44
8	GU10	51	58	A	430	950	36	2.700	25.000	50000	10	4000870 283455	☑	283.45

R, L



### Aluminium Aluminio Alluminio

W	⊖	∅ mm	↑ mm	⬠	lm /90°	cd	✂	K	⌚	ON/OFF	📦	EAN	☑	
3,5	GU10	51	54	A <sup>+</sup>	230	550	38	2.700	20.000	50000	7	4000870 282991	☑	282.99
6,5	GU10	51	54	A <sup>+</sup>	425	950	38	2.700	20.000	50000	7	4000870 283004	☑	283.00



### Glass Cristal Vetro

W	⊖	∅ mm	↑ mm	⬠	lm /90°	cd	✂	K	⌚	ON/OFF	📦	EAN	☑	
3,2	GU10	51	53	A <sup>+</sup>	230	500	36	2.700	15.000	50000	10	4000870 284094	☑	284.09
5,3	GU10	51	53	A <sup>+</sup>	345	650	36	2.700	15.000	50000	10	4000870 284100	☑	284.10



### Silver Plateado Argentó

W	⊖	∅ mm	↑ mm	⬠	lm /90°	cd	✂	K	⌚	ON/OFF	📦	EAN	☑	
3,7	GU10	51	53	A <sup>+</sup>	230	500	36	2.700	15.000	50000	10	4000870 284339	☑	new 284.33
5,7	GU10	51	53	A <sup>+</sup>	350	650	36	2.700	15.000	50000	10	4000870 284346	☑	new 284.34

R, C



*Diamond Diamond Diamond*

W	⊖	∅ mm	⊖ mm	⊖	lm /90°	cd	⚡	K	⌚	ON/OFF	📦	EAN	✓	
3	GU10	51	52	A*	250	450	45	2.700	15.000	50000	10	4000870 282854	✓	282.85



Long neck

*Diamond Diamond Diamond*

W	⊖	∅ mm	⊖ mm	⊖	lm /90°	cd	⚡	K	⌚	ON/OFF	📦	EAN	✓	
3	GU10	51	80	A*	250	450	45	2.700	15.000	50000	10	4000870 283554	✓	283.55



Maxiflood

*Soft opal Ópalo suave Opale tenue*

W	⊖	∅ mm	⊖ mm	⊖	lm	cd	⚡	K	⌚	ON/OFF	📦	EAN	✓	
3,5	GU10	51	53	A*	250			2.700	15.000	50000	10	4000870 282861	✓	282.86

*Silver Plateado Argentó*



W	⊖	∅ mm	⊖ mm	⊖	lm /90°	cd	⚡	K	⌚	ON/OFF	📦	EAN	✓	
1	GU10	51	55	A*	35	150	20	3.000	10.000	10000	10	4000870 280485	✓	280.48

1	GU10	51	55	A*	35	170	20	6.500	10.000	10000	10	4000870 280119	✓	280.11
---	------	----	----	----	----	-----	----	-------	--------	-------	----	----------------	---	--------



*Aluminium Aluminio Alluminio*

W	⊖	∅ mm	⊖ mm	⊖	lm /90°	cd	⚡	K	⌚	ON/OFF	📦	EAN	✓	
7,5	GU10	51	57	A*	470	1.000	35	6.500	20.000	50000	10	4000870 282465	✓	282.46



*Aluminium Aluminio Alluminio*

W	⊖	∅ mm	⊖ mm	⊖	lm /90°	cd	⚡	K	⌚	ON/OFF	📦	EAN	✓	
3,5	GU10	51	53	A*	200	800	24	2.700	20.000	50000	10	4000870 282199	✓	282.19



Aluminium Aluminium Alluminio

W	⊖	∅ mm	↑ mm	⬠	lm /120°	cd	✂	K	⌚	ON/OFF	📦	EAN	☑	
3	GU10	51	57	A*	135	65	100	2.700	20.000	50000	10	4000870 282328	✓	282.32
3	GU10	51	56	A*	150	70	100	6.500	20.000	50000	10	4000870 282472	✓	282.47



Red Rojo Rosso



W	⊖	∅ mm	↑ mm	⬠	lm	cd	✂	K	⌚	ON/OFF	📦	EAN	☑	
2,8	GU10	51	53	A	100		25		20.000		10	4000870 282526	✓	282.52



Green Verde Verde



W	⊖	∅ mm	↑ mm	⬠	lm	cd	✂	K	⌚	ON/OFF	📦	EAN	☑	
3,5	GU10	51	53	A*	200		25		20.000		10	4000870 282540	✓	282.54



Blue Azul Blu



W	⊖	∅ mm	↑ mm	⬠	lm	cd	✂	K	⌚	ON/OFF	📦	EAN	☑	
3,5	GU10	51	53	B	40		25		20.000		10	4000870 282533	✓	282.53



Red Rojo Rosso



W	⊖	∅ mm	↑ mm	⬠	lm /90°	cd	✂	K	⌚	ON/OFF	📦	EAN	☑	
1	GU10	51	55	A	18		20		10.000		10	4000870 280072	✓	280.07



Yellow Amarillo Giallo



W	⊖	∅ mm	↑ mm	⬠	lm /90°	cd	✂	K	⌚	ON/OFF	📦	EAN	☑	
1	GU10	51	52	A	21		20		10.000		10	4000870 280089	✓	280.08



Blue Azul Blu



W	⊖	∅ mm	↑ mm	⬠	lm /90°	cd	✂	K	⌚	ON/OFF	📦	EAN	☑	
1	GU10	51	52	A	18		20		10.000		10	4000870 280102	✓	280.10



Multicolour Multicolor Multicolore



W	⊖	∅ mm	↑ mm	⬠	lm /90°	cd	✂	K	⌚	ON/OFF	📦	EAN	☑	
1	GU10	51	52				20		10.000		10	4000870 280133	✓	280.13





Aluminium Aluminio Alluminio

W	⚡	∅ mm	↑ mm	⏏	lm /90°	cd	✂	K	🕒	ON/OFF	📦	EAN	📄	
4	GU10	111	70	A+	350	1.150	24	2.700	15.000	50000	1	4000870 285145	✓	<b>new 285.14</b>

QPAR 111



Aluminium Aluminio Alluminio

W	⚡	∅ mm	↑ mm	⏏	lm /90°	cd	✂	K	🕒	ON/OFF	📦	EAN	📄	
11	GU10	110	80	A	590	1.900	25	2.700	20.000	50000	10	4000870 282847	✓	<b>282.84</b>

QPAR 111



Aluminium Aluminio Alluminio

W	⚡	∅ mm	↑ mm	⏏	lm /120°	cd	✂	K	🕒	ON/OFF	📦	EAN	📄	
7	GX53	75	42	A	350	136	120	3.000	30.000	120000	8	4000870 281338	✓	<b>281.33</b>



Grow light Luz de crecimiento Luce per piante

🌱 CRI >90  
DECO

W	⚡	∅ mm	↑ mm	⏏	lm /90°	cd	✂	K	🕒	ON/OFF	📦	EAN	📄	
4,5	E27	63	102	A	180	700	30	4.000	15.000	50000	6	4000870 283417	✓	<b>283.41</b>

R63 Plant light



Silver Plateado Argentó

W	⚡	∅ mm	↑ mm	⏏	lm /90°	cd	✂	K	🕒	ON/OFF	📦	EAN	📄	
4,5	E14	50	85	A	225	800	24	2.700	20.000	50000	8	4000870 282380	✓	<b>282.38</b>

R50



R50

Warm white Blanco cálido Bianco caldo

W	⚡	∅ mm	↑ mm	⏏	lm /90°	cd	✂	K	🕒	ON/OFF	📦	EAN	☑	new	price
3,5	E14	50	84	A+	230	460	36	2.700	15.000	50000	8	4000870 284605	☑		284.60



R63

Warm white Blanco cálido Bianco caldo

W	⚡	∅ mm	↑ mm	⏏	lm /90°	cd	✂	K	🕒	ON/OFF	📦	EAN	☑	new	price
5	E27	63	95	A+	370	960	36	2.700	15.000	50000	6	4000870 284612	☑		284.61



R80

Opal Opal Opale

W	⚡	∅ mm	↑ mm	⏏	lm /120°	cd	✂	K	🕒	ON/OFF	📦	EAN	☑	new	price
10	E27	80	114	A+	806		110	2.700	25.000	50000	5	4000870 284445	☑		284.44



PAR38

Clear Transparente Trasparente

W	⚡	∅ mm	↑ mm	⏏	lm /90°	cd	✂	K	🕒	ON/OFF	📦	EAN	☑	new	price
10	E27	121	136	A+	900	3.400	25	2.700	25.000	50000	3	4000870 284452	☑		284.45





Opal Opal Opale



W	⚡	∅ mm	↑ mm	⬠	lm	cd	✂	K	🕒	ON/OFF	📦	EAN	✓	
6	E27	60	112	A*	470			2.700	25.000	50000	10	4000870 283509	✓	283.50
10	E27	62	116	A*	806			2.700	25.000	50000	10	4000870 283493	✓	283.49
10	E27	62	116	A*	806			6.500	25.000	50000	10	4000870 283486	✓	283.48



Opal Opal Opale

W	⚡	∅ mm	↑ mm	⬠	lm	cd	✂	K	🕒	ON/OFF	📦	EAN	✓	
6,5	E27	60	110	A*	470			2.700	20.000	50000	6	4000870 282977	✓	282.97
9,5	E27	60	120	A*	806			2.700	20.000	50000	6	4000870 282984	✓	282.98



Opal Opal Opale

W	⚡	∅ mm	↑ mm	⬠	lm	cd	✂	K	🕒	ON/OFF	📦	EAN	✓	
6,5	E27	60	110	A*	470			2.700	20.000	50000	6	4000870 282281	✓	282.28
7	E27	60	110	A*	470			6.500	20.000	50000	6	4000870 282441	✓	282.44
11	E27	60	110	A*	806			6.500	20.000	50000	6	4000870 282458	✓	282.45

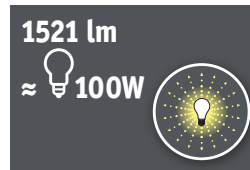

Opal Opal Opale

W	⚡	∅ mm	↑ mm	⬠	lm	cd	✂	K	🕒	ON/OFF	📦	EAN	✓	
13	E27	60	117	A*	1.521			2.700	15.000	50000	1	4000870 283981	✓	283.98



Clear Transparente Transparente

W	⚡	∅ mm	↑ mm	⬠	lm	cd	✂	K	🕒	ON/OFF	📦	EAN	✓	
3	E27	55	94	A*	260			2.700	15.000	50000	6	4000870 281888	✓	281.88



Satin Satinado Satinato

W	⚡	∅ mm	↑ mm	⬠	lm	cd	✂	K	🕒	ON/OFF	📦	EAN	✓	
3	E27	55	91	A*	250			2.700	15.000	50000	6	4000870 282717	✓	282.71



Satin Satinado Satinato

W	⚡	∅ mm	↑ mm	⬠	lm	cd	✂	K	🕒	ON/OFF	📦	EAN	✓	
5	E27	60	110	A*	470			2.700	15.000	50000	6	4000870 282786	✓	282.78

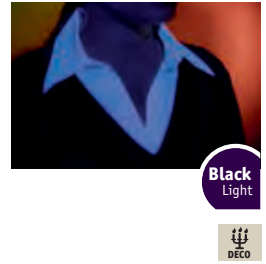

Black light Luz negra Luce nera

W	⚡	∅ mm	↑ mm	⏏	lm	cd	✂	K	🕒	ON/OFF	📦	EAN	☑	282.17
5	E27	60	110		1				15.000		6	4000870 282175	✓	282.17



- ▶ Bluetooth Version 4.0 and higher
- ▶ Versión Bluetooth 4.0 y superior
- ▶ Bluetooth Version 4.0 e superiore
- ▶ Power consumption of speaker = max. 2 W
- ▶ Consumo de energía altavoz = máx. 2W
- ▶ Potenza assorbita altoparlante = max. 2W



Opal Opal Opale

**Bluetooth** 2W









W	⚡	∅ mm	↑ mm	⏏	lm	cd	✂	K	🕒	ON/OFF	📦	EAN	☑	283.61
5	E27	65	127	A*	370			2.700	20.000	50000	10	4000870 283615	✓	283.61

Smartbulb



- ▶ Bluetooth Version 4.0 and higher
- ▶ Versión Bluetooth 4.0 y superior
- ▶ Bluetooth Version 4.0 e superiore

Smartphone control:

-  16 000 000 colors incl. white
-  Music mode
-  Light alarm clock
-  Auto effects
-  Rolling colors
-  Scenes

**Bluetooth**



Opal Opal Opale



W	⚡	∅ mm	↑ mm	⏏	lm	cd	✂	K	🕒	ON/OFF	📦	EAN	☑	284.08
7	E27	60	112	A*	450			2.700	20.000	50000	10	4000870 284087	✓	284.08

Smartbulb



🔗 Multicolour Multicolor Multicolore



W	⚡	∅ mm	↑ mm	⬠	lm	cd	✂	K	🕒	ON/OFF	📦	EAN	☑	new
3,5	E27	74	148						3.000		1	4000870 284704	✓	284.70



🔗 Multicolour Multicolor Multicolore



W	⚡	∅ mm	↑ mm	⬠	lm	cd	✂	K	🕒	ON/OFF	📦	EAN	☑	new
1,5	E27	80	150						3.000		1	4000870 284711	✓	284.71



🔗 Opal Opal Opale



W	⚡	∅ mm	↑ mm	⬠	lm	cd	✂	K	🕒	ON/OFF	📦	EAN	☑	new
6,5	E27	60	126	A*	470			2.700	15.000	50000	6	4000870 284728	✓	284.72

PIR



🔗 Opal Opal Opale



W	⚡	∅ mm	↑ mm	⬠	lm	cd	✂	K	🕒	ON/OFF	📦	EAN	☑	new
3,5	E27	45	83	B	75				15.000	50000	6	4000870 285183	✓	285.18



🔗 Opal Opal Opale



W	⚡	∅ mm	↑ mm	⬠	lm	cd	✂	K	🕒	ON/OFF	📦	EAN	☑	new
3,5	E14	35	99	B	75				15.000	50000	6	4000870 285176	✓	285.17



*Decorative LED lamps – Filament and Full Glass Bulbs*  
*Decorativas lámparas LED – Filamento y ampolla de vidrio*  
*Lampadine LED decorative – Filamento e vetro pieno*



Clear Transparente Trasparente

W	⚡	∅ mm	↑ mm	⬡	lm	cd	✂	K	⌚	ON/OFF	📦	EAN	✓	
2x4	E27	60	104	A+	470			2.700	15.000	50000	10	4000870 284759	✓	<b>new 284.75</b>



Clear Transparente Trasparente

W	⚡	∅ mm	↑ mm	⬡	lm	cd	✂	K	⌚	ON/OFF	📦	EAN	✓	
5	E27	60	104	A+	470			2.700	15.000	50000	6	4000870 283783	✓	<b>283.78</b>
7,5	E27	60	104	A+	806			2.700	15.000	50000	6	4000870 283776	✓	<b>283.77</b>



Clear Transparente Trasparente

W	⚡	∅ mm	↑ mm	⬡	lm	cd	✂	K	⌚	ON/OFF	📦	EAN	✓	
7,5	E27	60	104	A+	806			2.700	15.000	50000	6	4000870 284230	✓	<b>new 284.23</b>



Opal Opal Opale

W	⚡	∅ mm	↑ mm	⬡	lm	cd	✂	K	⌚	ON/OFF	📦	EAN	✓	
4,5	E27	55	93	A+	430			2.700	20.000	50000	6	4000870 283325	✓	<b>283.32</b>
6	E27	60	108	A+	550			2.700	20.000	50000	6	4000870 283318	✓	<b>283.31</b>



Gold Oro Oro

W	⚡	∅ mm	↑ mm	⬡	lm	cd	✂	K	⌚	ON/OFF	📦	EAN	✓	
5	E27	60	104	A+	380			2.500	15.000	50000	6	4000870 283745	✓	<b>283.74</b>
7,5	E27	60	104	A+	550			2.500	15.000	50000	6	4000870 283738	✓	<b>283.73</b>





🔗 Crown mirror silver Cúpula espejo plateado Testina a specchio argentato

W	⚡	∅ mm	↑ mm	◻	lm	cd	✂	K	🕒	ON/OFF	📦	EAN	✓	
5	E27	60	104	A*	380			2.700	15.000	50000	6	4000870 283769	✓	283.76
7,5	E27	60	104	A*	550			2.700	15.000	50000	6	4000870 283752	✓	283.75



🔗 Crown mirror copper Cúpula espejo cobre Testina a specchio rame

W	⚡	∅ mm	↑ mm	◻	lm	cd	✂	K	🕒	ON/OFF	📦	EAN	✓	
7,5	E27	60	104	A*	680			2.700	15.000	50000	6	4000870 284568	✓	new 284.56



🔗 Red Rojo Rosso



W	⚡	∅ mm	↑ mm	◻	lm	cd	✂	K	🕒	ON/OFF	📦	EAN	✓	
1	E27	60	104	A*	20				15.000		6	4000870 284483	✓	new 284.48



🔗 Green Verde Verde



W	⚡	∅ mm	↑ mm	◻	lm	cd	✂	K	🕒	ON/OFF	📦	EAN	✓	
1	E27	60	104	A*	25				15.000		6	4000870 284490	✓	new 284.49



🔗 Blue Azul Blu



W	⚡	∅ mm	↑ mm	◻	lm	cd	✂	K	🕒	ON/OFF	📦	EAN	✓	
1	E27	60	104	A	10				15.000		6	4000870 284506	✓	new 284.50



🔗 Orange Naranja Arancione



W	⚡	∅ mm	↑ mm	◻	lm	cd	✂	K	🕒	ON/OFF	📦	EAN	✓	
1	E27	60	104	A*	25				15.000		6	4000870 284513	✓	new 284.51



🔗 Violet Violeta Violetto



W	⚡	∅ mm	↑ mm	◻	lm	cd	✂	K	🕒	ON/OFF	📦	EAN	✓	
1	E27	60	104	B	5				15.000		6	4000870 284520	✓	new 284.52



Opal Opal Opale



W	⊖	∅ mm	↑ mm	⬠	lm	cd	✂	K	⌚	ON/OFF	📦	EAN	☑	
5,5	E14	36	110	A*	470			2.700	25.000	50000	10	4000870 283516	☑	283.51



Opal Opal Opale



W	⊖	∅ mm	↑ mm	⬠	lm	cd	✂	K	⌚	ON/OFF	📦	EAN	☑	
6,5	E14	36	104	A*	470			2.700	25.000	50000	8	4000870 282083	☑	282.08



Opal Opal Opale

W	⊖	∅ mm	↑ mm	⬠	lm	cd	✂	K	⌚	ON/OFF	📦	EAN	☑	
4	E14	35	100	A*	250			2.700	20.000	50000	8	4000870 282915	☑	282.91



Opal Opal Opale

W	⊖	∅ mm	↑ mm	⬠	lm	cd	✂	K	⌚	ON/OFF	📦	EAN	☑	
3,5	E14	35	102	A*	260			6.500	15.000	50000	8	4000870 283400	☑	283.40



Opal Opal Opale

W	⊖	∅ mm	↑ mm	⬠	lm	cd	✂	K	⌚	ON/OFF	📦	EAN	☑	
6	E14	38	112	A*	470			2.700	20.000	50000	8	4000870 282922	☑	282.92



Satin Satinado Satinato

W	⊖	∅ mm	↑ mm	⬠	lm	cd	✂	K	⌚	ON/OFF	📦	EAN	☑	
2,5	E14	35	105	A*	200			2.700	15.000	50000	8	4000870 282663	☑	282.66

4	E14	35	105	A**	390			2.700	15.000	50000	8	4000870 283202	☑	283.20
---	-----	----	-----	-----	-----	--	--	-------	--------	-------	---	----------------	---	--------



Clear Transparente Trasparente

W	⊖	∅ mm	↑ mm	⬠	lm	cd	✂	K	⌚	ON/OFF	📦	EAN	☑	
2x2	E14	35	97	A**	250			2.700	15.000	50000	10	4000870 284742	☑	new 284.74



Clear Transparente Trasparente

W	⊖	∅ mm	↑ mm	◁	lm	cd	✂	K	⌚	ON/OFF	📦	EAN	☑	
2,5	E14	35	105	A+	200			2.700	15.000	50000	8	4000870 282618	✓	282.61
4	E14	35	105	A++	400			2.700	15.000	50000	8	4000870 283158	✓	283.15



Clear Transparente Trasparente

W	⊖	∅ mm	↑ mm	◁	lm	cd	✂	K	⌚	ON/OFF	📦	EAN	☑	
2,5	E14	35	105	A+	200			2.700	15.000	15000	8	4000870 281727	✓	281.72
4	E14	35	105	A++	400			2.700	15.000	50000	8	4000870 283080	✓	283.08



Gold Oro Oro



W	⊖	∅ mm	↑ mm	◁	lm	cd	✂	K	⌚	ON/OFF	📦	EAN	☑	
2,5	E14	35	105	A	180			2.600	15.000	15000	8	4000870 281734	✓	281.73



Gold kroko-ice Escarchado - malla dorada Kraklè dorato



W	⊖	∅ mm	↑ mm	◁	lm	cd	✂	K	⌚	ON/OFF	📦	EAN	☑	
2,5	E14	35	105	A+	180			2.600	15.000	15000	8	4000870 281741	✓	281.74
4	E14	35	105	A+	360			2.700	15.000	50000	8	4000870 283103	✓	283.10



Clear Transparente Trasparente

W	⊖	∅ mm	↑ mm	◁	lm	cd	✂	K	⌚	ON/OFF	📦	EAN	☑	
2,5	E14	35	126	A+	200			2.700	15.000	15000	8	4000870 281703	✓	281.70
4	E14	35	126	A++	400			2.700	15.000	50000	8	4000870 283066	✓	283.06



Satin Satinado Satinato

W	⊖	∅ mm	↑ mm	◁	lm	cd	✂	K	⌚	ON/OFF	📦	EAN	☑	
2,5	E14	35	126	A+	200			2.700	15.000	15000	8	4000870 281710	✓	281.71
4	E14	35	126	A++	390			2.700	15.000	50000	8	4000870 283073	✓	283.07



Clear Transparente Trasparente

W	⊖	∅ mm	↑ mm	◁	lm	cd	✂	K	⌚	ON/OFF	📦	EAN	☑	
2,5	E14	35	97	A+	250			2.700	15.000	50000	10	4000870 283639	✓	283.63



Opal Opal Opale

W	⊖	∅ mm	↑ mm	⬡	lm	cd	✂	K	⌚	ON/OFF	📦	EAN	☑	
2,5	E14	35	97	A+	220			2.700	20.000	50000	8	4000870 283356	✓	283.35



Satin Satinado Satinato

W	⊖	∅ mm	↑ mm	⬡	lm	cd	✂	K	⌚	ON/OFF	📦	EAN	☑	
2,5	E14	35	97	A+	250			2.700	15.000	50000	10	4000870 283660	✓	283.66



Satin Satinado Satinato

W	⊖	∅ mm	↑ mm	⬡	lm	cd	✂	K	⌚	ON/OFF	📦	EAN	☑	
2,5	E14	35	123	A+	250			2.700	15.000	50000	10	4000870 283622	✓	283.62



Clear Transparente Trasparente

W	⊖	∅ mm	↑ mm	⬡	lm	cd	✂	K	⌚	ON/OFF	📦	EAN	☑	
2,5	E14	35	97	A+	250			2.700	15.000	50000	10	4000870 283714	✓	283.71



Gold Oro Oro

W	⊖	∅ mm	↑ mm	⬡	lm	cd	✂	K	⌚	ON/OFF	📦	EAN	☑	
2,5	E14	35	97	A+	220			2.500	15.000	50000	10	4000870 283721	✓	283.72



Gold Oro Oro

W	⊖	∅ mm	↑ mm	⬡	lm	cd	✂	K	⌚	ON/OFF	📦	EAN	☑	
2,5	E14	35	97	A+	220			2.500	15.000	50000	10	4000870 283646	✓	283.64



Gold kroko-ice Escarchado - malla dorada Kraklè dorato

W	⊖	∅ mm	↑ mm	⬡	lm	cd	✂	K	⌚	ON/OFF	📦	EAN	☑	
2,5	E14	35	97	A+	220			2.500	15.000	50000	10	4000870 283653	✓	283.65



Opal Opal Opale



W	⊖	∅ mm	⋈ mm	□	lm	cd	✂	K	⌚	ON/OFF	📦	EAN	✓	new	price
4,5	E14	35	97	A++	450			2.700	15.000	50000	1	4000870 284957	✓		284.95



Satin Satinado Satinato



W	⊖	∅ mm	⋈ mm	□	lm	cd	✂	K	⌚	ON/OFF	📦	EAN	✓	new	price
4,5	E14	35	97	A++	470			2.700	15.000	50000	1	4000870 284964	✓		284.96



Clear Transparente Trasparente



W	⊖	∅ mm	⋈ mm	□	lm	cd	✂	K	⌚	ON/OFF	📦	EAN	✓	new	price
2,8	E14	35	120	A++	250			2.700	15.000	50000	1	4000870 285077	✓		285.07



Gold Oro Oro



W	⊖	∅ mm	⋈ mm	□	lm	cd	✂	K	⌚	ON/OFF	📦	EAN	✓	new	price
4,5	E14	35	97	A++	430			2.500	15.000	50000	1	4000870 284933	✓		284.93



Clear Transparente Trasparente



W	⊖	∅ mm	⋈ mm	□	lm	cd	✂	K	⌚	ON/OFF	📦	EAN	✓	new	price
4,5	E14	35	97	A++	470			2.700	15.000	50000	1	4000870 284940	✓		284.94



Clear kroko-ice Escarchado - malla clara Kraklè chiaro



W	⊖	∅ mm	⋈ mm	□	lm	cd	✂	K	⌚	ON/OFF	📦	EAN	✓	new	price
4,5	E14	35	97	A+	400			2.500	15.000	50000	1	4000870 284971	✓		284.97



Clear Transparente Trasparente



W	⊖	∅ mm	⋈ mm	□	lm	cd	✂	K	⌚	ON/OFF	📦	EAN	✓	new	price
4,5	E14	35	120	A++	470			2.700	15.000	50000	1	4000870 285084	✓		285.08



Satin Satinado Satinato



W	⊖	∅ mm	⊕ mm	◻	lm	cd	✂	K	⌚	ON/OFF	📦	EAN	☑	new
4,5	E14	35	120	A++	470			2.700	15.000	50000	1	4000870 284926	✓	284.92



Gold Oro Oro



W	⊖	∅ mm	⊕ mm	◻	lm	cd	✂	K	⌚	ON/OFF	📦	EAN	☑	new
4,5	E14	35	97	A++	430			2.500	15.000	50000	1	4000870 284988	✓	284.98



Clear Transparente Trasparente



W	⊖	∅ mm	⊕ mm	◻	lm	cd	✂	K	⌚	ON/OFF	📦	EAN	☑	new
4,5	E14	35	97	A++	470			2.700	15.000	50000	1	4000870 284995	✓	284.99



Clear Transparente Trasparente



W	⊖	∅ mm	⊕ mm	◻	lm	cd	✂	K	⌚	ON/OFF	📦	EAN	☑	new
4,5	E14	25	82	A++	470			2.700	15.000	50000	1	4000870 285060	✓	285.06



Clear Transparente Trasparente



W	⊖	∅ mm	⊕ mm	◻	lm	cd	✂	K	⌚	ON/OFF	📦	EAN	☑	new
2,8	E14	25	82	A++	250			2.700	15.000	50000	1	4000870 285053	✓	285.05



Opal Opal Opale

W	⊖	∅ mm	⊕ mm	◻	lm	cd	✂	K	⌚	ON/OFF	📦	EAN	☑	new
4,5	E14	30	132	A++	530			2.700	15.000	50000	1	4000870 285138	✓	285.13

Deco Tube





Deco Pipe



Satin Satinado Satinato



W	⊖	∅ mm	⇄ mm	◊	lm	cd	✂	K	⌚	ON/OFF	📦	EAN	✓	new	284.36
6	E27	38	150	A*	470			2.700	15.000	50000	8	4000870 284360	✓	new	284.36



Deco Pipe



Satin Satinado Satinato



W	⊖	∅ mm	⇄ mm	◊	lm	cd	✂	K	⌚	ON/OFF	📦	EAN	✓	new	284.35
6	E14	38	145	A*	470			2.700	15.000	50000	8	4000870 284353	✓	new	284.35



Deco Pipe



Opal Opal Opale

W	⊖	∅ mm	⇄ mm	◊	lm	cd	✂	K	⌚	ON/OFF	📦	EAN	✓	283.27
5,5	E14	38	142	A*	470			2.700	15.000	50000	8	4000870 283271	✓	283.27



Deco Pipe

Opal Opal Opale

W	⊖	∅ mm	⇄ mm	◊	lm	cd	✂	K	⌚	ON/OFF	📦	EAN	✓	283.28
5,5	E27	38	142	A*	470			2.700	15.000	50000	8	4000870 283288	✓	283.28



Opal Opal Opale



W	⚡	∅ mm	↑ mm	⬠	lm	cd	✂	K	🕒	ON/OFF	📦	EAN	✓	
9,5	E27	80	117	A+	806			2.700	25.000	50000	6	4000870 283547	✓	283.54



Opal Opal Opale

W	⚡	∅ mm	↑ mm	⬠	lm	cd	✂	K	🕒	ON/OFF	📦	EAN	✓	
10	E27	95	138	A+	1.055			2.700	15.000	50000	4	4000870 284476	✓	new 284.47



Opal Opal Opale



W	⚡	∅ mm	↑ mm	⬠	lm	cd	✂	K	🕒	ON/OFF	📦	EAN	✓	
9,5	E27	80	127	A+	806			2.700	25.000	50000	10	4000870 284698	✓	new 284.69



Opal Opal Opale

W	⚡	∅ mm	↑ mm	⬠	lm	cd	✂	K	🕒	ON/OFF	📦	EAN	✓	
5	E27	80	118	A+	470			2.700	15.000	50000	5	4000870 282809	✓	282.80



Satin Satinado Satinato

W	⚡	∅ mm	↑ mm	⬠	lm	cd	✂	K	🕒	ON/OFF	📦	EAN	✓	
5	E27	80	118	A+	470			2.700	15.000	50000	5	4000870 282793	✓	282.79



Opal Opal Opale

W	⚡	∅ mm	↑ mm	⬠	lm	cd	✂	K	🕒	ON/OFF	📦	EAN	✓	
4	E27	60	91	A+	370			2.700	15.000	50000	6	4000870 283134	✓	283.13



Opal Opal Opale

W	⚡	∅ mm	↑ mm	⬠	lm	cd	✂	K	🕒	ON/OFF	📦	EAN	✓	
4	E14	60	97	A+	370			2.700	15.000	50000	6	4000870 283141	✓	283.14



Satin Satinado Satinato

W	⊖	∅ mm	↑ mm	□	lm	cd	⚡	K	⌚	ON/OFF	📦	EAN	☑	
4	E27	60	91	A <sup>+</sup>	390			2.700	15.000	50000	6	4000870 283233	✓	283.23
2,5	E27	60	91	A <sup>+</sup>	200			2.700	15.000	50000	6	4000870 282700	✓	282.70



Satin Satinado Satinato

W	⊖	∅ mm	↑ mm	□	lm	cd	⚡	K	⌚	ON/OFF	📦	EAN	☑	
2,5	E14	60	97	A <sup>+</sup>	200			2.700	15.000	50000	6	4000870 282694	✓	282.69
4	E14	60	97	A <sup>+</sup>	390			2.700	15.000	50000	6	4000870 283240	✓	283.24



Clear Transparente Trasparente

W	⊖	∅ mm	↑ mm	□	lm	cd	⚡	K	⌚	ON/OFF	📦	EAN	☑	
2,5	E27	60	91	A <sup>+</sup>	200			2.700	15.000	50000	8	4000870 282656	✓	282.65



Clear Transparente Trasparente

W	⊖	∅ mm	↑ mm	□	lm	cd	⚡	K	⌚	ON/OFF	📦	EAN	☑	
2,5	E14	60	97	A <sup>+</sup>	200			2.700	15.000	50000	8	4000870 282649	✓	282.64
4	E14	60	97	A <sup>+</sup>	400			2.700	15.000	50000	6	4000870 283196	✓	283.19



Crown mirror silver Cúpula espejo plateado Testina a specchio argentato

W	⊖	∅ mm	↑ mm	□	lm	cd	⚡	K	⌚	ON/OFF	📦	EAN	☑	
2,5	E27	60	91	A <sup>+</sup>	160			2.700	15.000	50000	6	4000870 282823	✓	282.82

*Decorative LED lamps – Filament and Full Glass Bulbs*  
*Decorativas lámparas LED – Filamento y ampolla de vidrio*  
*Lampadine LED decorative – Filamento e vetro pieno*



🔗 Gold Oro Oro

W	⚡	∅ mm	↑ mm	⬡	lm	cd	↘	K	🕒	ON/OFF 📄	📦	EAN	📄	
2,5	E27	125	175	A*	170			1.700	15.000	50000	3	4000870 283790	✓	283.79
4	E27	125	175	A*	250			1.700	15.000	50000	3	4000870 283806	✓	283.80
6,5	E27	125	175	A*	420			1.700	15.000	50000	8	4000870 283813	✓	283.81



🔗 Opal Opal Opale

W	⚡	∅ mm	↑ mm	⬡	lm	cd	↘	K	🕒	ON/OFF 📄	📦	EAN	📄	
6	E27	120	173	A+	806			2.700	15.000	50000	1	4000870 284841	✓	new 284.84





Clear Transparente Trasparente



W	⚡	∅ mm	↑ mm	⬡	lm	cd	⚡	K	🕒	ON/OFF	📦	EAN	✓	
7,5	E27	125	178	A+	806			2.700	15.000	50000	3	4000870 284247	✓	<b>new 284.24</b>



Gold Oro Oro

W	⚡	∅ mm	↑ mm	⬡	lm	cd	⚡	K	🕒	ON/OFF	📦	EAN	✓	
2,5	E27	95	138	A+	170			1.700	15.000	50000	4	4000870 283882	✓	<b>283.88</b>
6,5	E27	95	138	A+	400			1.700	15.000	50000	4	4000870 283899	✓	<b>283.89</b>
7,5	E27	95	138	A+	550			2.500	15.000	50000	4	4000870 283868	✓	<b>283.86</b>



Crown mirror silver Cúpula espejo plateado Testina a specchio argentato

W	⚡	∅ mm	↑ mm	⬡	lm	cd	⚡	K	🕒	ON/OFF	📦	EAN	✓	
5	E27	95	138	A+	420			2.700	15.000	50000	4	4000870 283875	✓	<b>283.87</b>



Crown mirror silver Cúpula espejo plateado Testina a specchio argentato



W	⚡	∅ mm	↑ mm	⬡	lm	cd	⚡	K	🕒	ON/OFF	📦	EAN	✓	
6	E27	95	138	A+	750			2.700	15.000	50000	1	4000870 284780	✓	<b>new 284.78</b>



Crown mirror copper Cúpula espejo cobre Testina a specchio rame

W	⚡	∅ mm	↑ mm	⬡	lm	cd	⚡	K	🕒	ON/OFF	📦	EAN	✓	
7,5	E27	95	138	A+	680			2.700	15.000	50000	4	4000870 284575	✓	<b>new 284.57</b>



Opal Opal Opale



W	⚡	∅ mm	↑ mm	⏏	lm	cd	⚡	K	🕒	ON/OFF	📦	EAN	📦
6	E27	95	138	A+	806			2.700	15.000	50000	1	4000870 284872	✓ <b>new 284.87</b>



Gold kroko-ice Escarchado - malla dorada Kraklè dorato



W	⚡	∅ mm	↑ mm	⏏	lm	cd	⚡	K	🕒	ON/OFF	📦	EAN	📦
6	E27	95	138	A+	750			2.500	15.000	50000	1	4000870 284889	✓ <b>new 284.88</b>



Opal Opal Opale

W	⚡	∅ mm	↑ mm	⏏	lm	cd	⚡	K	🕒	ON/OFF	📦	EAN	📦
6	E27	80	121	A+	550			2.700	20.000	50000	5	4000870 283370	✓ <b>283.37</b>



Opal Opal Opale



W	⚡	∅ mm	↑ mm	⏏	lm	cd	⚡	K	🕒	ON/OFF	📦	EAN	📦
6	E27	80	120	A+	806			2.700	15.000	50000	1	4000870 284865	✓ <b>new 284.86</b>





Ice crystal clear Craquele claro Cristalli di ghiaccio chiaro





W	⚡	∅ mm	↑ mm	⏏	lm	cd	⚡	K	🕒	ON/OFF	📦	EAN	📦
6	E27	80	120	A+	750			2.700	15.000	50000	1	4000870 284858	✓ <b>new 284.85</b>





Opal Opal Opale R, L

W	⊖	∅ mm	↑ mm	⬠	lm	cd	✂	K	⌚	ON/OFF	📦	EAN	☑	
6,5	E27	45	77	A+	470			2.700	25.000	50000	8	4000870 282106	✓	282.10



Opal Opal Opale R, C

W	⊖	∅ mm	↑ mm	⬠	lm	cd	✂	K	⌚	ON/OFF	📦	EAN	☑	
6	E27	45	90	A+	470			2.700	25.000	50000	10	4000870 284681	✓	new 284.68



Clear Transparente Trasparente R, C

W	⊖	∅ mm	↑ mm	⬠	lm	cd	✂	K	⌚	ON/OFF	📦	EAN	☑	
6	E14	45	90	A+	470			2.700	25.000	50000	10	4000870 284674	✓	new 284.67

Opal Opal Opale R, L

W	⊖	∅ mm	↑ mm	⬠	lm	cd	✂	K	⌚	ON/OFF	📦	EAN	☑	
6,5	E27	45	79	A+	470			2.700	25.000	50000	10	4000870 283530	✓	283.53

Opal Opal Opale R, L

W	⊖	∅ mm	↑ mm	⬠	lm	cd	✂	K	⌚	ON/OFF	📦	EAN	☑	
6,5	E14	45	81	A+	470			2.700	25.000	50000	10	4000870 283523	✓	283.52





Opal Opal Opale

W	⊖	∅ mm	↑ mm	⬠	lm	cd	✂	K	⌚	ON/OFF	📦	EAN	☑	
4	E27	45	74	A+	250			2.700	20.000	50000	7	4000870 282946	✓	282.94





W	⊖	∅ mm	↑ mm	⬠	lm	cd	✂	K	⌚	ON/OFF	📦	EAN	☑	
4	E14	45	80	A+	250			2.700	20.000	50000	7	4000870 282939	✓	282.93

Opal Opal Opale

W	⊖	∅ mm	↑ mm	⬠	lm	cd	✂	K	⌚	ON/OFF	📦	EAN	☑	
6	E27	45	87	A+	470			2.700	20.000	50000	7	4000870 282960	✓	282.96

W	⊖	∅ mm	↑ mm	⬠	lm	cd	✂	K	⌚	ON/OFF	📦	EAN	☑	
6	E14	45	89	A+	470			2.700	20.000	50000	7	4000870 282953	✓	282.95

Opal Opal Opale

W	⊖	∅ mm	↑ mm	⬠	lm	cd	✂	K	⌚	ON/OFF	📦	EAN	☑	
6,5	E27	45	79	A+	470			2.700	20.000	50000	8	4000870 282434	✓	282.43

W	⊖	∅ mm	↑ mm	⬠	lm	cd	✂	K	⌚	ON/OFF	📦	EAN	☑	
6,5	E14	45	79	A+	470			2.700	20.000	50000	8	4000870 282427	✓	282.42



## Opal Opal Opale

W	⚡	∅ mm	↑ mm	⬡	lm	cd	⚡	K	⌚	ON/OFF	📦	EAN	☑	
3,5	E14	45	79	A*	260			6.500	15.000	50000	8	4000870 283394	☑	283.39

## Opal Opal Opale



W	⚡	∅ mm	↑ mm	⬡	lm	cd	⚡	K	⌚	ON/OFF	📦	EAN	☑	
2,5	E27	45	75	A*	190			2.700	15.000	15000	8	4000870 281765	☑	281.76

4	E27	45	75	A*	370			2.700	15.000	50000	8	4000870 283127	☑	283.12
---	-----	----	----	----	-----	--	--	-------	--------	-------	---	----------------	---	--------



W	⚡	∅ mm	↑ mm	⬡	lm	cd	⚡	K	⌚	ON/OFF	📦	EAN	☑	
2,5	E14	45	81	A*	190			2.700	15.000	15000	8	4000870 281758	☑	281.75

4	E14	45	81	A*	370			2.700	15.000	50000	8	4000870 283110	☑	283.11
---	-----	----	----	----	-----	--	--	-------	--------	-------	---	----------------	---	--------

## Satin Satinado Satinato



W	⚡	∅ mm	↑ mm	⬡	lm	cd	⚡	K	⌚	ON/OFF	📦	EAN	☑	
2,5	E27	45	75	A*	200			2.700	15.000	50000	8	4000870 282687	☑	282.68



W	⚡	∅ mm	↑ mm	⬡	lm	cd	⚡	K	⌚	ON/OFF	📦	EAN	☑	
2,5	E14	45	81	A*	200			2.700	15.000	50000	8	4000870 282670	☑	282.67

4	E14	45	81	A**	390			2.700	15.000	50000	8	4000870 283219	☑	283.21
---	-----	----	----	-----	-----	--	--	-------	--------	-------	---	----------------	---	--------

## Clear Transparente Transparente



W	⚡	∅ mm	↑ mm	⬡	lm	cd	⚡	K	⌚	ON/OFF	📦	EAN	☑	
2,5	E27	45	75	A*	200			2.700	15.000	50000	8	4000870 282632	☑	282.63

4	E27	45	75	A**	400			2.700	15.000	50000	8	4000870 283172	☑	283.17
---	-----	----	----	-----	-----	--	--	-------	--------	-------	---	----------------	---	--------

W	⚡	∅ mm	↑ mm	⬡	lm	cd	⚡	K	⌚	ON/OFF	📦	EAN	☑	
2,5	E14	45	81	A*	200			2.700	15.000	50000	8	4000870 282625	☑	282.62

W	⚡	∅ mm	↑ mm	⬡	lm	cd	⚡	K	⌚	ON/OFF	📦	EAN	☑	
4	E14	45	81	A**	400			2.700	15.000	50000	8	4000870 283165	☑	283.16



## Clear Transparente Transparente

W	⚡	∅ mm	↑ mm	⬡	lm	cd	⚡	K	⌚	ON/OFF	📦	EAN	☑	
2x2	E14	45	78	A**	250			2.700	15.000	50000	10	4000870 284766	☑	new 284.76



Clear Transparente Traspirente

W	⚡	∅ mm	↑ mm	⬠	lm	cd	✂	K	🕒	ON/OFF	📦	EAN	📄	
2,5	E14	45	80	A <sup>+</sup>	250			2.700	15.000	50000	8	4000870 283707	✓	283.70



W	⚡	∅ mm	↑ mm	⬠	lm	cd	✂	K	🕒	ON/OFF	📦	EAN	📄	
2,5	E27	45	78	A <sup>+</sup>	250			2.700	15.000	50000	8	4000870 283851	✓	283.85



Opal Opal Opale

W	⚡	∅ mm	↑ mm	⬠	lm	cd	✂	K	🕒	ON/OFF	📦	EAN	📄	
2,5	E14	45	78	A <sup>+</sup>	220			2.700	20.000	50000	8	4000870 283349	✓	283.34



W	⚡	∅ mm	↑ mm	⬠	lm	cd	✂	K	🕒	ON/OFF	📦	EAN	📄	
2,5	E27	45	78	A <sup>+</sup>	220			2.700	20.000	50000	8	4000870 283332	✓	283.33



Gold Oro Oro

W	⚡	∅ mm	↑ mm	⬠	lm	cd	✂	K	🕒	ON/OFF	📦	EAN	📄	
2,5	E14	45	80	A <sup>+</sup>	220			2.500	15.000	50000	8	4000870 283677	✓	283.67



W	⚡	∅ mm	↑ mm	⬠	lm	cd	✂	K	🕒	ON/OFF	📦	EAN	📄	
2,5	E27	45	78	A <sup>+</sup>	200			2.500	15.000	50000	8	4000870 283820	✓	283.82



Gold kroko-ice Escarchado - malla dorada Kraklè dorato

W	⚡	∅ mm	↑ mm	⬠	lm	cd	✂	K	🕒	ON/OFF	📦	EAN	📄	
2,5	E14	45	80	A <sup>+</sup>	220			2.500	15.000	50000	8	4000870 283684	✓	283.68



W	⚡	∅ mm	↑ mm	⬠	lm	cd	✂	K	🕒	ON/OFF	📦	EAN	📄	
2,5	E27	45	78	A <sup>+</sup>	200			2.500	15.000	50000	8	4000870 283837	✓	283.83



Crown mirror silver Cúpula espejo plateado Testina a specchio argentato

W	⚡	∅ mm	↑ mm	⬠	lm	cd	✂	K	🕒	ON/OFF	📦	EAN	📄	
2,5	E14	45	80	A <sup>+</sup>	220			2.700	15.000	50000	8	4000870 283691	✓	283.69





W	⚡	∅ mm	↑ mm	⬠	lm	cd	✂	K	🕒	ON/OFF	📦	EAN	📄	
2,5	E27	45	78	A <sup>+</sup>	200			2.700	15.000	50000	8	4000870 283844	✓	283.84





Crown mirror copper Cúpula espejo cobre Testina a specchio rame

W	⚡	∅ mm	↑ mm	⬠	lm	cd	✂	K	🕒	ON/OFF	📦	EAN	📄	
2,5	E14	45	80	A <sup>+</sup>	250			2.700	15.000	50000	8	4000870 284551	✓	new 284.55



Clear Transparente Trasparente 

W	⊖	∅ mm	↑ mm	⬠	lm	cd	✂	K	⌚	ON/OFF	ⓦ	EAN	✓	new	285.01
4,5	E14	45	78	A+	470			2.700	15.000	50000	1	4000870 285015	✓		



Clear Transparente Trasparente 

W	⊖	∅ mm	↑ mm	⬠	lm	cd	✂	K	⌚	ON/OFF	ⓦ	EAN	✓	new	284.80
4,5	E27	45	83	A+	470			2.700	15.000	50000	1	4000870 284803	✓		



Opal Opal Opale 

W	⊖	∅ mm	↑ mm	⬠	lm	cd	✂	K	⌚	ON/OFF	ⓦ	EAN	✓	new	285.02
4,5	E14	45	78	A+	450			2.700	15.000	50000	1	4000870 285022	✓		



Opal Opal Opale 

W	⊖	∅ mm	↑ mm	⬠	lm	cd	✂	K	⌚	ON/OFF	ⓦ	EAN	✓	new	284.81
4,5	E27	45	83	A+	400			2.700	15.000	50000	1	4000870 284810	✓		



Gold Oro Oro 

W	⊖	∅ mm	↑ mm	⬠	lm	cd	✂	K	⌚	ON/OFF	ⓦ	EAN	✓	new	285.00
4,5	E14	45	78	A+	430			2.500	15.000	50000	1	4000870 285008	✓		



Gold Oro Oro 

W	⊖	∅ mm	↑ mm	⬠	lm	cd	✂	K	⌚	ON/OFF	ⓦ	EAN	✓	new	284.79
4,5	E27	45	83	A+	400			2.500	15.000	50000	1	4000870 284797	✓		



Clear kroko-ice Escarchado - malla clara Kraklè chiaro 

W	⊖	∅ mm	↑ mm	⬠	lm	cd	✂	K	⌚	ON/OFF	ⓦ	EAN	✓	new	285.03
4,5	E14	45	78	A+	400			2.500	15.000	50000	1	4000870 285039	✓		



Gold kroko-ice Escarchado - malla dorada Kraklè dorato 

W	⊖	∅ mm	↑ mm	⬠	lm	cd	✂	K	⌚	ON/OFF	ⓦ	EAN	✓	new	284.82
4,5	E27	45	83	A+	400			2.500	15.000	50000	1	4000870 284827	✓		

Crown mirror silver Cúpula espejo plateado Testina a specchio argentato 

W	⊖	∅ mm	↑ mm	⬠	lm	cd	✂	K	⌚	ON/OFF	ⓦ	EAN	✓	new	285.04
4,5	E14	45	78	A+	400			2.500	15.000	50000	1	4000870 285046	✓		

Crown mirror silver Cúpula espejo plateado Testina a specchio argentato 

W	⊖	∅ mm	↑ mm	⬠	lm	cd	✂	K	⌚	ON/OFF	ⓦ	EAN	✓	new	284.83
4,5	E27	45	83	A+	400			2.700	15.000	50000	1	4000870 284834	✓		



Clear Transparente Trasparente



W	⊖	∅ mm	⋈ mm	⬡	lm	cd	✂	K	⌚	ON/OFF	⊞	EAN	☑	
7,5	E27	64	140	A*	806			2.700	15.000	50000	6	4000870 284254	☑	<b>new 284.25</b>



Clear Transparente Trasparente

W	⊖	∅ mm	⋈ mm	⬡	lm	cd	✂	K	⌚	ON/OFF	⊞	EAN	☑	
2,5	E27	64	145	A*	180			1.800	15.000	50000	6	4000870 283936	☑	<b>283.93</b>
4	E27	64	145	A*	300			1.800	15.000	50000	6	4000870 283929	☑	<b>283.92</b>



Gold Oro Oro

W	⊖	∅ mm	⋈ mm	⬡	lm	cd	✂	K	⌚	ON/OFF	⊞	EAN	☑	
2,5	E27	64	145	A*	150			1.700	15.000	50000	6	4000870 283943	☑	<b>283.94</b>
4	E27	64	145	A*	250			1.700	15.000	50000	6	4000870 283950	☑	<b>283.95</b>
5	E27	64	145	A*	420			2.500	15.000	50000	6	4000870 283905	☑	<b>283.90</b>
7,5	E27	64	145	A*	550			2.500	15.000	50000	6	4000870 283912	☑	<b>283.91</b>





Clear Transparente Trasparente

W	⊖	∅ mm	↑ mm	⬠	lm	cd	✂	K	🕒	ON/OFF	📦	EAN	☑	🏷
9	R7s	24	118	A*	1.000			2.700	25.000	50000	10	4000870 284582	✓	new 284.58



Clear Transparente Trasparente

W	⊖	∅ mm	↑ mm	⬠	lm	cd	✂	K	🕒	ON/OFF	📦	EAN	☑	🏷
5	R7s	24	78	A*	500			2.700	25.000	50000	10	4000870 284599	✓	new 284.59



White Blanco Bianco



W	⊖	∅ mm	↑ mm	⬠	lm	cd	✂	K	🕒	ON/OFF	📦	EAN	☑	🏷
12	R7s	48	118	A*	850			4.000	15.000	50000	10	4000870 282113	✓	282.11
12	R7s	48	118	A	806			2.700	15.000	50000	10	4000870 282120	✓	282.12







gold LED light

1879

classic edition



Gold Oro Oro

W	⊖	∅ mm	↑ mm	⬠	lm	cd	⚡	K	⌚	ON/OFF	📦	EAN	🏷️
2,5	E27	95	138	A*	170			1.700	15.000	50000	1	4000870 283998	new 283.99
6,5	E27	95	138	A	400			1.700	15.000	50000	1	4000870 284001	new 284.00



Gold Oro Oro

W	⊖	∅ mm	↑ mm	⬠	lm	cd	⚡	K	⌚	ON/OFF	📦	EAN	🏷️
2,5	E27	125	175	A*	170			1.700	15.000	50000	1	4000870 284018	new 284.01
4	E27	125	175	A*	250			1.700	15.000	50000	1	4000870 284025	new 284.02
6,5	E27	125	175	A*	420			1.700	15.000	50000	1	4000870 284032	new 284.03



Clear Transparente Trasparente

W	⊖	∅ mm	↑ mm	⬠	lm	cd	⚡	K	⌚	ON/OFF	📦	EAN	🏷️
2,5	E27	64	154	A*	180			1.800	15.000	50000	1	4000870 284049	new 284.04
4	E27	64	145	A*	300			1.800	15.000	50000	1	4000870 284056	new 284.05



Gold Oro Oro

W	⊖	∅ mm	↑ mm	⬠	lm	cd	✂	K	⌚	ON/OFF	⊞	EAN	☑
2,5	E27	64	145	A <sup>+</sup>	150			1.700	15.000	50000	1	4000870 284063	new 284.06
4	E27	64	145	A <sup>+</sup>	250			1.700	15.000	50000	1	4000870 284070	new 284.07



Gold Oro Oro

W	⊖	∅ mm	↑ mm	⬠	lm	cd	✂	K	⌚	ON/OFF	⊞	EAN	☑
2	E14	35	97	A <sup>++</sup>	160			1.700	15.000	15000	10	4000870 285244	new 285.24



Gold Oro Oro

W	⊖	∅ mm	↑ mm	⬠	lm	cd	✂	K	⌚	ON/OFF	⊞	EAN	☑
2	E14	45	78	A <sup>++</sup>	160			1.700	15.000	15000	8	4000870 285251	new 285.25



Gold Oro Oro

W	⊖	∅ mm	↑ mm	⬠	lm	cd	✂	K	⌚	ON/OFF	⊞	EAN	☑
2	E14	25	80	A <sup>++</sup>	160			1.700	15.000	15000	10	4000870 285268	new 285.26



Gold Oro Oro

W	⊖	∅ mm	↑ mm	⬠	lm	cd	✂	K	⌚	ON/OFF	⊞	EAN	☑
6	E27	60	104	A <sup>+</sup>	500			1.700	15.000	50000	6	4000870 285220	new 285.22



Gold Oro Oro

W	⊖	∅ mm	↑ mm	⬠	lm	cd	✂	K	⌚	ON/OFF	⊞	EAN	☑
6	E27	95	138	A <sup>+</sup>	500			1.700	15.000	50000	4	4000870 285213	new 285.21



Gold Oro Oro

W	⊖	∅ mm	↑ mm	⬠	lm	cd	✂	K	⌚	ON/OFF	⊞	EAN	☑
6	E27	64	145	A <sup>+</sup>	500			1.700	15.000	50000	6	4000870 285237	new 285.23





Clear Transparente Trasparente



W	⊖	∅ mm	↑ mm	⬠	lm	cd	✂	K	⌚	ON/OFF	📦	EAN	☑	
1	E14	21	60		50			3.000	30.000		10	4000870 281109	☑	281.10
1	E14	21	60		50			6.500	30.000		10	4000870 281116	☑	281.11

Opal Opal Opale



W	⊖	∅ mm	↑ mm	⬠	lm	cd	✂	K	⌚	ON/OFF	📦	EAN	☑	
1,8	E14	25	59	A+	140			2.700	15.000	50000	10	4000870 283561	☑	283.56

Opal Opal Opale



W	⊖	∅ mm	↑ mm	⬠	lm	cd	✂	K	⌚	ON/OFF	📦	EAN	☑	
3	E14	25	71	A+	250			2.700	15.000	50000	10	4000870 283578	☑	283.57

Clear Transparente Trasparente



W	⊖	∅ mm	↑ mm	⬠	lm	cd	✂	K	⌚	ON/OFF	📦	EAN	☑	
2	E14	26	65	A+	180			2.700	15.000	50000	10	4000870 284735	☑	new 284.73

Clear Transparente Trasparente



W	⊖	∅ mm	↑ mm	⬠	lm	cd	✂	K	⌚	ON/OFF	📦	EAN	☑	
3,5	E27	30	82	A+	340			2.700	15.000	50000	10	4000870 284117	☑	284.11

Clear Transparente Trasparente



W	⊖	∅ mm	↑ mm	⬠	lm	cd	✂	K	⌚	ON/OFF	📦	EAN	☑	
3,5	E14	30	86	A+	340			2.700	15.000	50000	10	4000870 284131	☑	284.13

Satin Satinado Satinato



W	⊖	∅ mm	↑ mm	⬠	lm	cd	✂	K	⌚	ON/OFF	📦	EAN	☑	
3,5	E27	30	82	A+	310			2.700	15.000	50000	10	4000870 284124	☑	284.12

Satin Satinado Satinato



W	⊖	∅ mm	↑ mm	⬠	lm	cd	✂	K	⌚	ON/OFF	📦	EAN	☑	
3,5	E14	30	86	A+	310			2.700	15.000	50000	10	4000870 284148	☑	284.14



Opal Opal Opale



W	⊖	∅ mm	↑ mm	⬠	lm	cd	✂	K	⌚	ON/OFF	📦	EAN	☑	
4	S14d	30	300	A+	330			2.700	15.000	50000	10	4000870 283035	✓	283.03



Opal Opal Opale



W	⊖	∅ mm	↑ mm	⬠	lm	cd	✂	K	⌚	ON/OFF	📦	EAN	☑	
4	S14s	30	300	A+	330			2.700	15.000	50000	10	4000870 283028	✓	283.02



Opal Opal Opale



W	⊖	∅ mm	↑ mm	⬠	lm	cd	✂	K	⌚	ON/OFF	📦	EAN	☑	
6,5	S14d	30	500	A+	500			2.700	15.000	50000	10	4000870 283059	✓	283.05



Opal Opal Opale



W	⊖	∅ mm	↑ mm	⬠	lm	cd	✂	K	⌚	ON/OFF	📦	EAN	☑	
6,5	S14s	30	500	A+	500			2.700	15.000	50000	10	4000870 283042	✓	283.04

► For conventional ballasts only

► Solo para estabilizadores convencionales

► Solo per alimentatori convenzionali



Opal Opal Opale

T8



W	⊖	∅ mm	↑ mm	⬠	lm	cd	✂	K	⌚	ON/OFF	📦	EAN	☑	
9	G13	27	604	A+	900		170	4.000	25.000	50000	10	4000870 284155	✓	284.15



Opal Opal Opale

T8



W	⊖	∅ mm	↑ mm	⬠	lm	cd	✂	K	⌚	ON/OFF	📦	EAN	☑	
18	G13	27	1.214	A+	1.800		170	4.000	25.000	50000	10	4000870 284162	✓	284.16



Opal Opal Opale

T8



W	⊖	∅ mm	↑ mm	⬠	lm	cd	✂	K	⌚	ON/OFF	📦	EAN	☑	
22	G13	27	1.515	A+	2.300		170	4.000	25.000	50000	10	4000870 284179	✓	284.17



Opal Opal Opale

CRI >90

W	⊖	∅ mm	↑ mm	⬠	lm /90°	cd	⚡	K	⌚	ON/OFF	📦	EAN	☑	
6,5	GU10	51	54	A*	350	820	36	2.700	25.000	50000	7	4000870 284438	✓	new 284.43



Opal Opal Opale

CRI >90

W	⊖	∅ mm	↑ mm	⬠	lm	cd	⚡	K	⌚	ON/OFF	📦	EAN	☑	
6	E27	60	110	A*	470		240	2.700	15.000	50000	1	4000870 284896	✓	new 284.89



Opal Opal Opale

CRI >90

W	⊖	∅ mm	↑ mm	⬠	lm	cd	⚡	K	⌚	ON/OFF	📦	EAN	☑	
9,5	E27	60	120	A*	806		240	2.700	15.000	50000	1	4000870 284902	✓	new 284.90



Opal Opal Opale

CRI >90

W	⊖	∅ mm	↑ mm	⬠	lm	cd	⚡	K	⌚	ON/OFF	📦	EAN	☑	
4	E14	35	110	A*	250			2.700	25.000	50000	8	4000870 284391	✓	new 284.39
7	E14	38	112	A*	470			2.700	25.000	50000	8	4000870 284407	✓	new 284.40



Opal Opal Opale

CRI >90

W	⊖	∅ mm	↑ mm	⬠	lm	cd	⚡	K	⌚	ON/OFF	📦	EAN	☑	
4	E14	45	80	A*	250			2.700	25.000	50000	7	4000870 284414	✓	new 284.41
7	E14	45	89	A*	470			2.700	25.000	50000	7	4000870 284421	✓	new 284.42



AR 111

Aluminium Aluminio Alluminio

W	⊖	∅ mm	↑ mm	⬠	lm /120°	cd	⚡	K	⌚	ON/OFF	📦	EAN	☑	
8	G53	111	56	A*	500	2.100	24	2.700	15.000	50000	1	4000870 285152	✓	new 285.15

10.5 VA

## Energy-saving / fluorescent bulbs

Lámparas fluorescentes / de bajo consumo

Lampade a risparmio energetico / lampade fluorescenti

**454** Energy-saving lamps  
Lámparas ahorro de energía  
Lampade a risparmio energetico

**457** Fluorescent lights  
Lámparas fluorescentes  
Lampade fluorescenti



### Lumen comparison

### Comparativa de lúmenes

### Comparazione luminosità

Lighting technology  
Luminotecnia  
Soluzione illuminotecnica

(Incandescent) lamp watts  
Lámpara (incandescente) vatios  
Lampadina (a incandescenza) Watt

LED brightness in lumen  
Luminosidad LED en lúmenes  
Luminosità LED in Lumen

Omnidirectional lamps  
Proyectores omnidireccionales  
Luci omnidirezionali

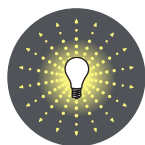

Classic incandescent light bulb Lámpara incandescente clásica Lampadina a incandescenza classica <b>E14, E27, GU10</b>		15 W	140 lm
		25 W	250 lm
		40 W	470 lm
		60 W	806 lm
		75 W	1055 lm
		100 W	1521 lm
Halogen 230V <b>G9, E27, R7s</b>		25 W	250 lm
		40 W	470 lm
		60 W	806 lm
Halogen 12V <b>G4, GY6,35</b>		5 W	45 lm
		10 W	90 lm
		20 W	190 lm
		35 W	390 lm
		50 W	630 lm

Reflector lamps  
Lámparas con reflector  
Riflettori

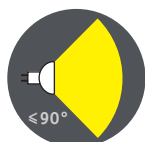

Halogen 230V <b>E14, E27, GU10</b>		25 W	125 lm
		35 W	200 lm
		50 W	300 lm
Halogen 12V <b>GU4, GU5,3</b>		10 W	80 lm/90 lm (GU4/GU5,3)
		20 W	160 lm/180 lm (GU4/GU5,3)
		35 W	300 lm
		50 W	540 lm





Opal Opal Opale

W	⚡	∅ mm	↑ mm	⏏	lm	cd	✂	K	⌚	ON/OFF	📦	EAN	📄
23	E27	118	175	A	1.400			2.700	8.000	30000	3	4000870 883198	✓

**883.19**



Opal Opal Opale

W	⚡	∅ mm	↑ mm	⏏	lm	cd	✂	K	⌚	ON/OFF	📦	EAN	📄
20	E27	95	128	A	1.248			2.700	8.000	30000	4	4000870 883211	✓

**883.21**



Opal Opal Opale

W	⚡	∅ mm	↑ mm	⏏	lm	cd	✂	K	⌚	ON/OFF	📦	EAN	📄
11	E27	60	111	A	560			2.700	8.000	30000	6	4000870 883136	✓

**883.13**



Satin Satinado Satinato

W	⚡	∅ mm	↑ mm	⏏	lm	cd	✂	K	⌚	ON/OFF	📦	EAN	📄
10	E27	100	140	A	565			2.700	8.000	30000	4	4000870 880562	✓

**880.56**



Opal Opal Opale

W	⚡	∅ mm	↑ mm	⏏	lm	cd	✂	K	⌚	ON/OFF	📦	EAN	📄
20	E27	65	140	A	1.250			2.700	8.000	30000	5	4000870 890202	✓

**890.20**





Deco Pipe

Satin Satinado Satinato

W	⚡	∅ mm	⊕ mm	⏏	lm	cd	✂	K	🕒	ON/OFF	📦	EAN	☑	
11	E27	38	140	A	550			2.700	8.000	30000	8	4000870 894118	☑	894.11



Deco Pipe

Satin Satinado Satinato

W	⚡	∅ mm	⊕ mm	⏏	lm	cd	✂	K	🕒	ON/OFF	📦	EAN	☑	
9	E14	38	143	A	405			2.700	8.000	30000	8	4000870 894095	☑	894.09



Deco Pipe

Satin Satinado Satinato

W	⚡	∅ mm	⊕ mm	⏏	lm	cd	✂	K	🕒	ON/OFF	📦	EAN	☑	
9	E14	38	182	A	460			2.700	8.000	30000	8	4000870 894194	☑	894.19



Opal Opal Opale

W	⚡	∅ mm	⊕ mm	⏏	lm	cd	✂	K	🕒	ON/OFF	📦	EAN	☑	
10	GU10	30	145	A	546			2.700	8.000	30000	8	4000870 883389	☑	883.38



Opal Opal Opale

W	⚡	∅ mm	⊕ mm	⏏	lm	cd	✂	K	🕒	ON/OFF	📦	EAN	☑	
7	GU10	30	89	A	334			2.700	8.000	30000	8	4000870 860021	☑	860.02





Opal Opal Opale



W	⚡	∅ mm	↑ mm	⬠	lm	cd	♀	K	🕒	ON/OFF	📦	EAN	☑	
7	GX53	75	26	B	230		100	2.700	10.000	30000	4	4000870 885147	☑	<b>885.14</b>
9	GX53	75	26	B	320		100	2.700	10.000	30000	4	4000870 883235	☑	<b>883.23</b>



Opal Opal Opale

W	⚡	∅ mm	↑ mm	⬠	lm	cd	♀	K	🕒	ON/OFF	📦	EAN	☑	
9	E14	38	130	A	490			2.700	8.000	30000	8	4000870 860076	☑	<b>860.07</b>



Opal Opal Opale

W	⚡	∅ mm	↑ mm	⬠	lm	cd	♀	K	🕒	ON/OFF	📦	EAN	☑	
9	E27	37	100	A	513			2.700	10.000	30000	8	4000870 880142	☑	<b>880.14</b>



Opal Opal Opale

W	⚡	∅ mm	↑ mm	⬠	lm	cd	♀	K	🕒	ON/OFF	📦	EAN	☑	
11	E27	48	108	A	650			2.700	10.000	30000	8	4000870 880159	☑	<b>880.15</b>
15	E27	48	119	A	950			2.700	10.000	30000	8	4000870 892398	☑	<b>892.39</b>
20	E27	48	130	A	1.200			2.700	10.000	30000	8	4000870 892404	☑	<b>892.40</b>



Opal Opal Opale

W	⚡	∅ mm	↑ mm	⬠	lm	cd	♀	K	🕒	ON/OFF	📦	EAN	☑	
9	E14	46	95	A	500			2.700	10.000	30000	8	4000870 894392	☑	<b>894.39</b>



Opal Opal Opale

W	⚡	∅ mm	↑ mm	⏏	lm	color	K	⌚	ON/OFF	📦	EAN	✓	
36	2GX13	26	600	A*	3.350	830	3.000	8.000		6	4000870 884454	✓	884.45

T8



Opal Opal Opale

W	⚡	∅ mm	↑ mm	⏏	lm	color	K	⌚	ON/OFF	📦	EAN	✓	
22	2GX13	16	223	A	1.720	827	2.700	12.000		1	4000870 884485	✓	884.48
40	2GX13	16	298	A	3.550	827	2.700	12.000		1	4000870 884478	✓	884.47
55	2GX13	16	298	B	4.125	827	2.700	12.000		1	4000870 884461	✓	884.46

T5



Opal Opal Opale

W	⚡	∅ mm	↑ mm	⏏	lm	color	K	⌚	ON/OFF	📦	EAN	✓	
32	G10q	30	302	B	2.250	827	2.700	8.000		1	4000870 884324	✓	884.32
40	G10q	30	403	A	2.800	827	2.700	8.000		1	4000870 884409	✓	884.40

T9



Opal Opal Opale

W	⚡	∅ mm	↑ mm	⏏	lm	color	K	⌚	ON/OFF	📦	EAN	✓	
24	E27	227	80	A	1.445	827	2.700	8.000	10000	1	4000870 860038	✓	860.03





Opal Opal Opale

T5

W	⊖	∅ mm	↑ mm	⊏	lm	color	K	⌚	ON/OFF	ⓦ	EAN	☑	
8	G5	16	301	A	480	830	3.000	5.000		10	4000870 885086	☑	<b>885.08</b>
13	G5	16	530	A	950	830	3.000	5.000		10	4000870 885130	☑	<b>885.13</b>
8	G5	16	301	A	440	840	4.000	5.000		10	4000870 885604	☑	<b>885.60</b>
13	G5	16	530	A	950	840	4.000	5.000		10	4000870 885611	☑	<b>885.61</b>
14	G5	16	560	A*	1.205	840	4.000	10.000		10	4000870 885635	☑	<b>885.63</b>
21	G5	16	864	A*	1.890	840	4.000	10.000		10	4000870 885628	☑	<b>885.62</b>
35	G5	16	1.463	A*	3.310	840	4.000	10.000		10	4000870 885642	☑	<b>885.64</b>

T5

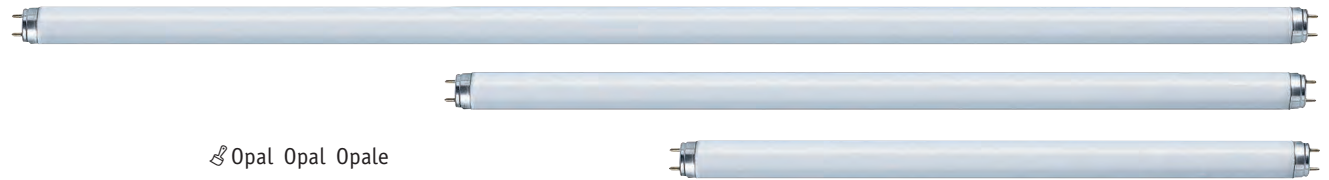

Opal Opal Opale

T8

W	⊖	∅ mm	↑ mm	⊏	lm	color	K	⌚	ON/OFF	ⓦ	EAN	☑	
15	G13	26	451	B	963	827	2.700	8.000		10	4000870 885154	☑	<b>885.15</b>
18	G13	26	604	A	1.350	827	2.700	8.000		10	4000870 885215	☑	<b>885.21</b>
30	G13	26	910	A	2.400	827	2.700	8.000		10	4000870 885451	☑	<b>885.45</b>
36	G13	26	1.214	A*	3.348	827	2.700	8.000		10	4000870 885499	☑	<b>885.49</b>
58	G13	26	1.515	A	5.220	827	2.700	8.000		10	4000870 885536	☑	<b>885.53</b>
18	G13	26	604	A	1.350	840	4.000	8.000		10	4000870 885413	☑	<b>885.41</b>
30	G13	26	910	A	2.400	840	4.000	8.000		10	4000870 885208	☑	<b>885.20</b>
36	G13	26	1.214	A*	3.348	840	4.000	8.000		10	4000870 885505	☑	<b>885.50</b>
58	G13	26	1.515	A	5.167	840	4.000	8.000		10	4000870 885543	☑	<b>885.54</b>
18	G13	26	604	A	1.215	865	6.500	8.000		10	4000870 885192	☑	<b>885.19</b>
30	G13	26	910	A	2.160	865	6.500	8.000		10	4000870 885444	☑	<b>885.44</b>
36	G13	26	1.214	A	3.013	865	6.500	8.000		10	4000870 885369	☑	<b>885.36</b>
58	G13	26	1.515	A	4.698	865	6.500	8.000		10	4000870 885581	☑	<b>885.58</b>

T8

T8



Starter Universal

White Blanco Bianco

W	∅ mm	↑ mm	ⓦ	EAN	☑	
max. 4-65	20	39	1	4000870 884843	☑	<b>884.84</b>
max. 2x4-22	20	39	1	4000870 884249	☑	<b>884.24</b>

## Halogen lamps 12V

## Lámparas halógenas de 12V

## Lampade alogene da 12V

- 460** Halogen capsules  
Portalámparas  
Zoccolo ad innesto
- 460** Reflector lights GU4  
Lámparas reflectoras GU4  
Lampade a riflettore GU4
- 461** Reflector lights GU5,3  
Lámparas reflectoras GU5,3  
Lampade a riflettore GU5,3



### Lumen comparison

### Comparativa de lúmenes

### Comparazione luminosità

Lighting technology  
Luminotecnia  
Soluzione illuminotecnica

(Incandescent) lamp watts  
Lámpara (incandescente) vatios  
Lampadina (a incandescenza) Watt

LED brightness in lumen  
Luminosidad LED en lúmenes  
Luminosità LED in Lumen

Omnidirectional lamps  
Proyectoras omnidireccionales  
Luci omnidirezionali

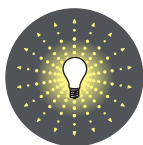

Classic incandescent light bulb Lámpara incandescente clásica Lampadina a incandescenza classica <b>E14, E27, GU10</b>		15 W	140 lm
		25 W	250 lm
		40 W	470 lm
		60 W	806 lm
		75 W	1055 lm
		100 W	1521 lm
Halogen 230V <b>G9, E27, R7s</b>		25 W	250 lm
		40 W	470 lm
		60 W	806 lm
Halogen 12V <b>G4, GY6,35</b>		5 W	45 lm
		10 W	90 lm
		20 W	190 lm
		35 W	390 lm
		50 W	630 lm

Reflector lamps  
Lámparas con reflector  
Riflettori

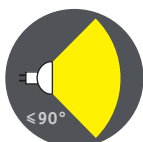

Halogen 230V <b>E14, E27, GU10</b>		25 W	125 lm
		35 W	200 lm
		50 W	300 lm
Halogen 12V <b>GU4, GU5,3</b>		10 W	80 lm/90 lm (GU4/GU5,3)
		20 W	160 lm/180 lm (GU4/GU5,3)
		35 W	300 lm
		50 W	540 lm



Clear Transparente Trasparente



W	⚡	∅ mm	⚗ mm	◻	lm	cd	⚡	K	🕒	ON/OFF	📦	EAN	✓	
2x10	G4	9	33	C	130			2.900	2.000	8000	10	4000870 831151	✓	831.15
2x20	G4	9	33	C	290			2.900	2.000	8000	10	4000870 831175	✓	831.17
2x35	G4	9	33	C	533			2.900	2.000	8000	10	4000870 800348	✓	800.34

Clear Transparente Trasparente



W	⚡	∅ mm	⚗ mm	◻	lm	cd	⚡	K	🕒	ON/OFF	📦	EAN	✓	
2x20	GY6,35	10	38	C	255			2.900	2.000	8000	10	4000870 831168	✓	831.16
2x35	GY6,35	10	38	C	600			2.900	2.000	8000	10	4000870 831182	✓	831.18
2x50	GY6,35	10	38	C	834			2.900	2.000	8000	10	4000870 831199	✓	831.19



Cool beam

Silver Plateado Argentó



W	⚡	∅ mm	⚗ mm	◻	lm /90°	cd	⚡	K	🕒	ON/OFF	📦	EAN	✓	
2x10	GU4	35	35	B	74	280	30	2.900	2.000	8000	10	4000870 838242	✓	838.24

► Security

► Diffuses 80 % of the heat to the front (special coating). Ideal for recessed lighting (no hazard for insulating material)

► Security

► Disipa el 80% del calor por delante (recubrimiento de superficie especial). Ideal para lámparas empotrables (sin riesgo para el material aislante)

► Security

► Devia l'80% del calore verso la parte anteriore (rivestimento speciale). Ideale per le luci a incasso (non danneggia i materiali isolanti)



Silver Plateado Argentó



Security

W	⚡	∅ mm	⚗ mm	◻	lm /90°	cd	⚡	K	🕒	ON/OFF	📦	EAN	✓	
2x20	GU4	35	35	B	220	470	30	2.900	2.000	8000	10	4000870 832479	✓	832.47
3x20	GU4	35	35	B	201	450	24	3.000	4.000	16000	1	4000870 833827	✓	new 833.82
3x35	GU4	35	35	B	430	800	24	3.000	4.000	16000	1	4000870 833834	✓	new 833.83

► Maxiflood

► Radiates evenly in every direction (ideal for colored lamp shades)

► Maxiflood

► Alumbra circularmente en todas las direcciones (ideal para pantallas de color)

► Maxiflood

► Illuminazione omogenea a 360 gradi (ideale per i paralumi colorati)

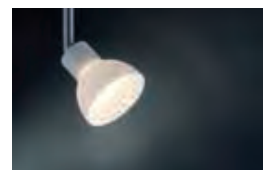

Soft opal Ópalo suave Opale tenue

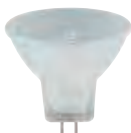

Maxiflood

W	⚡	∅ mm	⚗ mm	◻	lm	cd	⚡	K	🕒	ON/OFF	📦	EAN	✓	
2x20	GU4	35	35	C	280			2.900	2.000	8000	10	4000870 832332	✓	832.33
2x35	GU4	35	35	C	533			2.900	2.000	8000	10	4000870 833766	✓	833.76

- ▶ Juwel
- ▶ Brilliant halogen light shines to the front; satin-coloured reflections shimmering to the back.

- ▶ Juwel
- ▶ Brillante luz halógena hacia el frente y tenues reflejos satinados hacia atrás.

- ▶ Juwel
- ▶ Luce alogena brillante sul davanti e riflessi scintillanti in colori satinati dietro.

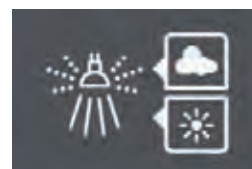

Juwel

🎧 Satin Satinado Satinato



W	☞	∅ mm	↑ mm	◁	lm /90°	cd	✂	K	🕒	ON/OFF	📦	EAN	☑	
2x20	GU4	35	35	B	220	730	30	2.900	2.000	8000	10	4000870 838266	☑	838.26



Cool beam

🎧 Silver Plateado Argento



W	☞	∅ mm	↑ mm	◁	lm /90°	cd	✂	K	🕒	ON/OFF	📦	EAN	☑	
20	GU5,3	51	45	B	203	700	38	2.900	4.000	16000	10	4000870 833797	☑	833.79

- ▶ Security
- ▶ Diffuses 80 % of the heat to the front (special coating). Ideal for recessed lighting (no hazard for insulating material)

- ▶ Security
- ▶ Disipa el 80% del calor por delante (recubrimiento de superficie especial). Ideal para lámparas empotrables (sin riesgo para el material aislante)

- ▶ Security
- ▶ Devia l'80% del calore verso la parte anteriore (rivestimento speciale). Ideale per le luci a incasso (non danneggia i materiali isolanti)



🎧 Silver Plateado Argento

W	☞	∅ mm	↑ mm	◁	lm /90°	cd	✂	K	🕒	ON/OFF	📦	EAN	☑	
20	GU5,3	51	45	B	200	700	38	2.900	4.000	16000	10	4000870 832448	☑	832.44
35	GU5,3	51	45	B	430	1.100	38	2.900	4.000	16000	10	4000870 832455	☑	832.45
50	GU5,3	51	45	B	675	1.800	38	2.900	4.000	16000	10	4000870 832462	☑	832.46



Security

W	☞	∅ mm	↑ mm	◁	lm /90°	cd	✂	K	🕒	ON/OFF	📦	EAN	☑	
3x20	GU5,3	51	46	B	201	450	38	3000	4.000	16000	1	4000870 833841	☑	new 833.84
3x35	GU5,3	51	46	B	430	800	38	3000	4.000	16000	1	4000870 833858	☑	new 833.85
3x50	GU5,3	51	46	B	680	1.300	38	3000	4.000	16000	1	4000870 833865	☑	new 833.86

- ▶ Maxiflood
- ▶ Radiates evenly in every direction (ideal for colored lamp shades)

- ▶ Maxiflood
- ▶ Alumbrada circularmente en todas las direcciones (ideal para pantallas de color)

- ▶ Maxiflood
- ▶ Illuminazione omogenea a 360 gradi (ideale per i paralumi colorati)



Maxiflood

🎧 Soft opal Ópalo suave Opale tenue

W	☞	∅ mm	↑ mm	◁	lm	cd	✂	K	🕒	ON/OFF	📦	EAN	☑	
20	GU5,3	51	45	C	255			2.900	2.000	8000	10	4000870 832530	☑	832.53
35	GU5,3	51	45	C	532			2.900	2.000	8000	10	4000870 832608	☑	832.60

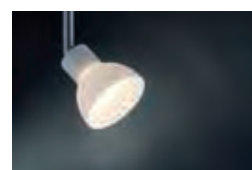

- ▶ Juwel
- ▶ Brilliant halogen light shines to the front; satin-coloured reflections shimmering to the back.

- ▶ Juwel
- ▶ Brillante luz halógena hacia el frente y tenues reflejos satinados hacia atrás.

- ▶ Juwel
- ▶ Luce alogena brillante sul davanti e riflessi scintillanti in colori satinati dietro.



🔗 Silver Plateado Argento



W	⚡	∅ mm	↑ mm	⏏	lm /90°	cd	⚡	K	🕒	ON/OFF	📦	EAN	☑	
20	GU5,3	51	45	B	200	700	38	2.900	4.000	16000	10	4000870 833148	☑	833.14

Juwel

- ▶ Akzent
- ▶ Durable outer coating in aluminium, silver, black or gold

- ▶ Akzent
- ▶ Duradero recubrimiento exterior en aluminio, plata, negro u oro

- ▶ Akzent
- ▶ Rivestimento esterno di lunga durata in alluminio, argento, nero oppure oro



🔗 Aluminium Aluminio Alluminio

W	⚡	∅ mm	↑ mm	⏏	lm /90°	cd	⚡	K	🕒	ON/OFF	📦	EAN	☑	
35	GU5,3	51	45	B	435	1.100	38	2.900	4.000	16000	10	4000870 832097	☑	832.09

Akzent



Quadro



Hexagonal

🔗 Silver Plateado Argento

W	⚡	∅ mm	↑ mm	⏏	lm /90°	cd	⚡	K	🕒	ON/OFF	📦	EAN	☑	
20	GU5,3	37	45	B	201	220	75	2.900	2.000	8000	10	4000870 833711	☑	833.71

35	GU5,3	37	45	B	427	460	75	2.900	2.000	8000	10	4000870 833742	☑	833.74
----	-------	----	----	---	-----	-----	----	-------	-------	------	----	----------------	---	--------

W	⚡	∅ mm	↑ mm	⏏	lm /90°	cd	⚡	K	🕒	ON/OFF	📦	EAN	☑	
20	GU5,3	51	45	B	201	450	60	2.900	2.000	8000	10	4000870 832233	☑	832.23

35	GU5,3	51	45	B	427	855	60	2.900	2.000	8000	10	4000870 832257	☑	832.25
----	-------	----	----	---	-----	-----	----	-------	-------	------	----	----------------	---	--------



🔗 Silver Plateado Argento

W	⚡	∅ mm	↑ mm	⏏	lm /90°	cd	⚡	K	🕒	ON/OFF	📦	EAN	☑	
50	G53	111	58	B	510	3.500	24	2.900	2.000	8000	10	4000870 832615	☑	832.61

AR 111

🔗 Silver Plateado Argento

W	⚡	∅ mm	↑ mm	⏏	lm	cd	⚡	K	🕒	ON/OFF	📦	EAN	☑	
50	G53	111	58	B	510	3.500	24	2.900	4.000	8000	10	4000870 832660	☑	new 832.66

AR 111

# Halogen lamps 230V

## Lámparas halógenas de 230V

### Lampade alogene da 230V



#### Lumen comparison

#### Comparativa de lúmenes

#### Comparazione luminosità

Lighting technology  
Luminotecnia  
Soluzione illuminotecnica

(Incandescent) lamp watts  
Lámpara (incandescente) vatios  
Lampadina (a incandescenza) Watt

LED brightness in lumen  
Luminosidad LED en lúmenes  
Luminosità LED in Lumen

Omnidirectional lamps  
Proyectores omnidireccionales  
Luci omnidirezionali

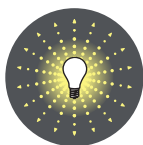

Classic incandescent light bulb Lámpara incandescente clásica Lampadina a incandescenza classica <b>E14, E27, GU10</b>		15 W	140 lm
		25 W	250 lm
		40 W	470 lm
		60 W	806 lm
		75 W	1055 lm
		100 W	1521 lm
Halogen 230V <b>G9, E27, R7s</b>		25 W	250 lm
		40 W	470 lm
		60 W	806 lm
Halogen 12V <b>G4, GY6,35</b>		5 W	45 lm
		10 W	90 lm
		20 W	190 lm
		35 W	390 lm
		50 W	630 lm

Reflector lamps  
Lámparas con reflector  
Riflettori

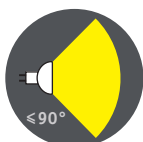

Halogen 230V <b>E14, E27, GU10</b>		25 W	125 lm
		35 W	200 lm
		50 W	300 lm
Halogen 12V <b>GU4, GU5,3</b>		10 W	80 lm/90 lm (GU4/GU5,3)
		20 W	160 lm/180 lm (GU4/GU5,3)
		35 W	300 lm
		50 W	540 lm



Clear Transparente Trasparente

W	⊖	∅ mm	∓ mm	□	lm	cd	✂	K	⌚	ON/OFF	⊞	EAN	☑	
60	R7s	12	78	D	971			2.900	2.000	8000	10	4000870 800607	✓	800.60



Clear Transparente Trasparente

W	⊖	∅ mm	∓ mm	□	lm	cd	✂	K	⌚	ON/OFF	⊞	EAN	☑	
120	R7s	12	117	D	2.216			2.900	2.000	8000	10	4000870 800591	✓	800.59
160	R7s	12	117	C	3.085			2.900	2.000	8000	10	4000870 800409	✓	800.40
230	R7s	12	117	C	4.644			3.000	2.000	8000	10	4000870 800416	✓	800.41
400	R7s	12	117	C	8.545			3.000	2.000	8000	10	4000870 800423	✓	800.42

Clear Transparente Trasparente

W	⊖	∅ mm	∓ mm	□	lm	cd	✂	K	⌚	ON/OFF	⊞	EAN	☑	
2x20	G9	13	42	D	240			2.700	2.000	8000	10	4000870 800300	✓	800.30
2x28	G9	13	42	D	370			2.700	2.000	8000	10	4000870 800621	✓	800.62
2x33	G9	13	42	D	460			2.800	2.000	8000	10	4000870 800317	✓	800.31
2x42	G9	13	42	D	625			2.800	2.000	8000	10	4000870 800324	✓	800.32
2x52	G9	13	42	D	815			2.800	2.000	8000	10	4000870 800331	✓	800.33
2x70	G9	13	42	D	1.173			2.900	2.000	8000	10	4000870 800638	✓	800.63



Clear Transparente Trasparente

W	⊖	∅ mm	∓ mm	□	lm	cd	✂	K	⌚	ON/OFF	⊞	EAN	☑	
33	G9	22	90	D	440			2.800	2.000	8000	10	4000870 800645	✓	800.64



Deco Pipe

Clear Transparente Trasparente

W	⊖	∅ mm	∓ mm	□	lm	cd	✂	K	⌚	ON/OFF	⊞	EAN	☑	
28	GZ10	22	80	C	340			2.700	1.000	4000	10	4000870 800652	✓	800.65
40	GZ10	22	80	C	570			2.800	1.000	4000	10	4000870 800669	✓	800.66



Deco Pipe



Maxiflood

Soft opal Ópalo suave Opale tenue

W	⚡	∅ mm	∩ mm	□	lm	cd	✂	K	⌚	ON/OFF	📦	EAN	✓	
28	GZ10	51	55	D	370			2.700	2.000	8000	10	4000870 800430	✓	800.43
40	GZ10	51	55	D	586			2.800	2.000	8000	10	4000870 800447	✓	800.44



White Blanco Bianco

W	⚡	∅ mm	∩ mm	cd	✂	K	⌚	ON/OFF	📦	EAN	✓	
max. 50	GU10 / E27	35	53						10	4000870 549292	✓	549.29





*Your own combination!*  
*¡Haga sus propias combinaciones!*  
*Scegliete da soli le combinazioni!*

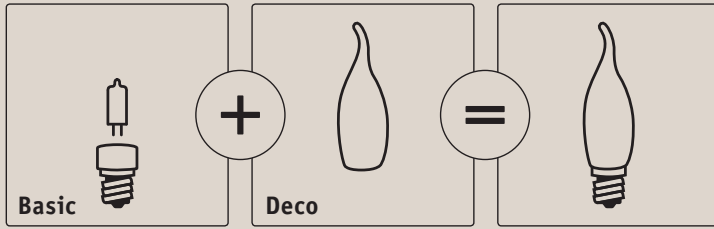

Decorated halogen lamps from Paulmann – all shapes, many colours

- ▶ Popular decorated shapes and colours for divers luminaire styles
- ▶ Opal matt surfaces
- ▶ For sockets with E14, E27, B22d or B15d sockets
- ▶ Brilliant light, efficient technology: Energy consumption reduced by up to 25% <sup>1)</sup>
- ▶ Do your own combinations: glass + socket = decorated lamp

Lámparas halógenas decoradas de Paulmann – todas las formas y muchos colores

- ▶ Variadas formas decorativas y colores para diversos estilos de lámpara
- ▶ Superficies en opal mate
- ▶ Para portalámparas con casquillo E14, E27, B22d o B15d
- ▶ Luz brillante, técnica eficiente: Hasta un 25 % de menor consumo energético <sup>1)</sup>
- ▶ Haga sus propias combinaciones: vidrio + portalámparas = lámpara decorativa

Lampadine alogene decorate Paulmann - tutte le forme e tanti colori

- ▶ Forme decorate e colori apprezzati per diversi stili di luci
- ▶ Superfici opali opache
- ▶ Per basi con portalampade E14, E27, B22d o B15d
- ▶ Luce brillante, tecnologia efficiente: Fino a 25 % di consumo energetico in meno <sup>1)</sup>
- ▶ Scegliete da soli le combinazioni - Vetro + base = Lampade decorate



<sup>1)</sup> Compared to a conventional bulb  
 Frente a lámparas incandescentes normales  
 Rispetto a una lampadina a incandescenza tradizionale

🔗 Clear Transparente Trasparente



W	⚡	∅ mm	∓ mm	◻	lm	cd	⚡	K	⌚	ON/OFF	📦	EAN	📄	
20	E27	28	51	D	235			2.700	2.000	8000	10	4000870 549162	✓	549.16
33	E27	28	51	D	460			2.800	2.000	8000	10	4000870 549179	✓	549.17
42	E27	28	51	D	630			2.800	2.000	8000	10	4000870 549186	✓	549.18
70	E27	28	51	D	1.173			2.900	2.000	8000	10	4000870 549261	✓	549.26

W	⚡	∅ mm	∓ mm	◻	lm	cd	⚡	K	⌚	ON/OFF	📦	EAN	📄	
20	E14	25	52	D	235			2.700	2.000	8000	10	4000870 549193	✓	549.19
33	E14	25	52	D	460			2.800	2.000	8000	10	4000870 549209	✓	549.20
42	E14	25	52	D	630			2.800	2.000	8000	10	4000870 549216	✓	549.21

🔗 White Blanco Bianco





W	⚡	∅ mm	∓ mm	lm	cd	⚡	K	⌚	ON/OFF	📦	EAN	📄	
	G9 / B22d	28	50							10	4000870 549278	✓	549.27

W	⚡	∅ mm	∓ mm	lm	cd	⚡	K	⌚	ON/OFF	📦	EAN	📄	
	G9 / B15d	25	50							10	4000870 549285	✓	549.28





Opal Opal Opale





∅ mm	↑ mm		EAN		
100	107	4	4000870 875698	✓	<b>875.69</b>





∅ mm	↑ mm		EAN		
80	88	5	4000870 875773	✓	<b>875.77</b>





∅ mm	↑ mm		EAN		
60	70	6	4000870 875759	✓	<b>875.75</b>





∅ mm	↑ mm		EAN		
45	52	8	4000870 875742	✓	<b>875.74</b>





∅ mm	↑ mm		EAN		
38	88	10	4000870 875766	✓	<b>875.76</b>

Satin Satinado Satinato





∅ mm	↑ mm		EAN		
60	70	6	4000870 870013	✓	<b>870.01</b>





∅ mm	↑ mm		EAN		
45	52	8	4000870 870037	✓	<b>870.03</b>





∅ mm	↑ mm		EAN		
38	88	10	4000870 870051	✓	<b>870.05</b>





∅ mm	↑ mm		EAN		
38	88	8	4000870 875728	✓	<b>875.72</b>





∅ mm	↑ mm		EAN		
35	90	8	4000870 875902	✓	<b>875.90</b>



∅ mm	↑ mm		EAN		
35	105	10	4000870 870075	✓	<b>870.07</b>



Ice crystal clear Craquele claro  
Cristalli di ghiaccio chiaro



∅ mm	↑ mm		EAN		
45	52	8	4000870 875636	✓	<b>875.63</b>

Ice crystal amber Craquele ámbar  
Cristalli di ghiaccio ambrato



∅ mm	↑ mm		EAN		
60	70	6	4000870 875605	✓	<b>875.60</b>

Gold kroko-ice  
Escarchado - malla dorada Kraklè dorato



∅ mm	↑ mm		EAN		
80	88	5	4000870 875858	✓	<b>875.58</b>



∅ mm	↑ mm		EAN		
60	70	6	4000870 875582	✓	<b>875.58</b>





Clear Transparente Trasparente

W	⚡	∅ mm	↑ mm	⬡	lm	cd	⚡	K	⌚	ON/OFF	📦	EAN	📦
18	E27	55	98	D	205			2.700	2.000	8000	6	4000870 400258	400.25
28	E27	55	98	D	370			2.700	2.000	8000	6	4000870 400265	400.26
42	E27	55	98	D	625			2.800	2.000	8000	6	4000870 400272	400.27
52	E27	60	106	D	815			2.800	2.000	8000	6	4000870 400289	400.28
70	E27	60	106	D	1.180			2.900	2.000	8000	6	4000870 400296	400.29



Clear Transparente Trasparente

W	⚡	∅ mm	↑ mm	⬡	lm	cd	⚡	K	⌚	ON/OFF	📦	EAN	📦
105	E27	60	105	C	1.900			2.900	2.000	8000	6	4000870 400173	✓ 400.17
120	E27	60	105	C	2.216			2.900	2.000	8000	6	4000870 400180	✓ 400.18



Clear Transparente Trasparente

W	⚡	∅ mm	↑ mm	⬡	lm	cd	⚡	K	⌚	ON/OFF	📦	EAN	📦
42	B22d	55	97	D	625			2.800	2.000	8000	6	4000870 400302	400.30
70	B22d	60	104	D	1.173			2.900	2.000	8000	6	4000870 400319	400.31



Clear Transparente Trasparente

W	⚡	∅ mm	↑ mm	⬡	lm	cd	⚡	K	⌚	ON/OFF	📦	EAN	📦
18	E14	35	98	D	205			2.700	2.000	8000	10	4000870 510421	510.42
28	E14	35	98	D	370			2.700	2.000	8000	10	4000870 510438	510.43
42	E14	35	98	D	625			2.800	2.000	8000	10	4000870 510445	510.44



Clear Transparente Trasparente

W	⚡	∅ mm	↑ mm	⬡	lm	cd	⚡	K	⌚	ON/OFF	📦	EAN	📦
18	E14	35	124	D	205			2.700	2.000	8000	10	4000870 510469	510.46
28	E14	35	124	D	370			2.700	2.000	8000	10	4000870 513286	513.28
42	E14	35	124	D	625			2.800	2.000	8000	10	4000870 513293	513.29





Clear Transparente Trasparente

W	⚡	∅ mm	↑ mm	⏏	lm	cd	✂	K	⌚	ON/OFF	📦	EAN	📦
20	E14	25	85	D	235			2.700	2.000	8000	10	4000870 540237	540.23
33	E14	25	85	D	458			2.800	2.000	8000	10	4000870 540244	540.24



Clear Transparente Trasparente

W	⚡	∅ mm	↑ mm	⏏	lm	cd	✂	K	⌚	ON/OFF	📦	EAN	📦
28	B22d	35	93	D	370			2.700	2.000	8000	10	4000870 510452	510.45



Clear Transparente Trasparente

W	⚡	∅ mm	↑ mm	⏏	lm	cd	✂	K	⌚	ON/OFF	📦	EAN	📦
18	E27	45	72	D	205			2.700	2.000	8000	8	4000870 800164	800.16
28	E27	45	74	D	370			2.700	2.000	8000	8	4000870 800171	800.17
42	E27	45	74	D	625			2.800	2.000	8000	8	4000870 800188	800.18



Clear Transparente Trasparente

W	⚡	∅ mm	↑ mm	⏏	lm	cd	✂	K	⌚	ON/OFF	📦	EAN	📦
18	E14	45	80	D	205			2.700	2.000	8000	8	4000870 314654	314.65
28	E14	45	80	D	370			2.700	2.000	8000	8	4000870 314661	314.66
42	E14	45	80	D	625			2.800	2.000	8000	8	4000870 314678	314.67



Clear Transparente Trasparente

W	⚡	∅ mm	↑ mm	⏏	lm	cd	✂	K	⌚	ON/OFF	📦	EAN	📦
28	B22d	45	72	D	370			2.700	2.000	8000	8	4000870 314685	314.68



## Conventional light bulbs

### Medios de iluminación convencionales

### Lampade convenzionali

- 471** Pygmy lamps  
Lámparas pygmy  
Lampadine
- 472** Drop lights  
Lámparas gota  
Lampade a goccia
- 473** Candle lights  
Lámparas vela  
Lampade a candela
- 474** Standard lights  
Lámparas estándar  
Lampade multiuso
- 475** Reflector lights  
Lámparas reflectoras  
Lampade a riflettore
- 476** Special lights  
Lámparas especiales  
Lampade speciali



#### Lumen comparison

#### Comparativa de lúmenes

#### Comparazione luminosità

Lighting technology  
Luminotecnica  
Soluzione illuminotecnica

(Incandescent) lamp watts  
Lámpara (incandescente) vatios  
Lampadina (a incandescenza) Watt

LED brightness in lumen  
Luminosidad LED en lúmenes  
Luminosità LED in Lumen

Omnidirectional lamps  
Proyectores omnidireccionales  
Luci omnidirezionali

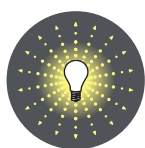

Classic incandescent light bulb Lámpara incandescente clásica Lampadina a incandescenza classica <b>E14, E27, GU10</b>		15 W	140 lm
		25 W	250 lm
		40 W	470 lm
		60 W	806 lm
		75 W	1055 lm
		100 W	1521 lm
Halogen 230V <b>G9, E27, R7s</b>		25 W	250 lm
		40 W	470 lm
		60 W	806 lm
Halogen 12V <b>G4, GY6,35</b>		5 W	45 lm
		10 W	90 lm
		20 W	190 lm
		35 W	390 lm
		50 W	630 lm

Reflector lamps  
Lámparas con reflector  
Riflettori

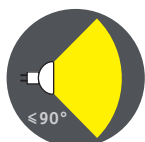

Halogen 230V <b>E14, E27, GU10</b>		25 W	125 lm
		35 W	200 lm
		50 W	300 lm
Halogen 12V <b>GU4, GU5,3</b>		10 W	80 lm/90 lm (GU4/GU5,3)
		20 W	160 lm/180 lm (GU4/GU5,3)
		35 W	300 lm
		50 W	540 lm



Clear Transparente Trasparente

W	⊖	∅ mm	↑ mm	⬠	lm	cd	✂	K	🕒	ON/OFF	📦	EAN	📺
7	E14	25	60	D	43			2.300	1.000		16	4000870 800157	<b>800.15</b>



Red Rojo Rosso



W	⊖	∅ mm	↑ mm	⬠	lm	cd	✂	K	🕒	ON/OFF	📦	EAN	📺
15	E14	25	60	E	26				1.000		16	4000870 800119	<b>800.11</b>



Yellow Amarillo Giallo



W	⊖	∅ mm	↑ mm	⬠	lm	cd	✂	K	🕒	ON/OFF	📦	EAN	📺
15	E14	25	60	E	83				1.000		16	4000870 800126	<b>800.12</b>



Green Verde Verde



W	⊖	∅ mm	↑ mm	⬠	lm	cd	✂	K	🕒	ON/OFF	📦	EAN	📺
15	E14	25	60	E	29				1.000		16	4000870 800133	<b>800.13</b>



TV - Blue TV azul TV - Blu



W	⊖	∅ mm	↑ mm	⬠	lm	cd	✂	K	🕒	ON/OFF	📦	EAN	📺
15	E14	25	60	E	20				1.000		16	4000870 810101	<b>810.10</b>







🎵 Matt Mate Interno opaco

W	⚡	∅ mm	↑ mm	⏏	lm	cd	✂	K	🕒	ON/OFF	📦	EAN	📦
8	E27	45	70	E	40			2.300	1.000		8	4000870 128084	128.08



🎵 Matt Mate Interno opaco

W	⚡	∅ mm	↑ mm	⏏	lm	cd	✂	K	🕒	ON/OFF	📦	EAN	📦
8	E14	45	78	E	40			2.300	1.000		8	4000870 127087	127.08



🎵 Red Rojo Rosso

W	⚡	∅ mm	↑ mm	⏏	lm	cd	✂	K	🕒	ON/OFF	📦	EAN	📦
25	E27	45	70	E	2				1.000		8	4000870 401316	401.31



W	⚡	∅ mm	↑ mm	⏏	lm	cd	✂	K	🕒	ON/OFF	📦	EAN	📦
25	E14	45	76	E	2				1.000		8	4000870 401217	401.21



🎵 Yellow Amarillo Giallo

W	⚡	∅ mm	↑ mm	⏏	lm	cd	✂	K	🕒	ON/OFF	📦	EAN	📦
25	E27	45	70	E	83				1.000		8	4000870 401323	401.32



W	⚡	∅ mm	↑ mm	⏏	lm	cd	✂	K	🕒	ON/OFF	📦	EAN	📦
25	E14	45	76	E	83				1.000		8	4000870 401224	401.22



🎵 Green Verde Verde

W	⚡	∅ mm	↑ mm	⏏	lm	cd	✂	K	🕒	ON/OFF	📦	EAN	📦
25	E27	45	70	E	7				1.000		8	4000870 401330	401.33



W	⚡	∅ mm	↑ mm	⏏	lm	cd	✂	K	🕒	ON/OFF	📦	EAN	📦
25	E14	45	76	E	7				1.000		8	4000870 401231	401.23



🎵 Blue Azul Blu

W	⚡	∅ mm	↑ mm	⏏	lm	cd	✂	K	🕒	ON/OFF	📦	EAN	📦
25	E27	45	70	E	1				1.000		8	4000870 401347	401.34



W	⚡	∅ mm	↑ mm	⏏	lm	cd	✂	K	🕒	ON/OFF	📦	EAN	📦
25	E14	45	76	E	1				1.000		8	4000870 401248	401.24





Matt Mate Interno opaco

W	⊖	∅ mm	↑ mm	⬠	lm	cd	✂	K	⌚	ON/OFF	📦	EAN	🏠
8	E27	35	95	E	40			2.300	1.000	4000	10	4000870 444085	444.08



Matt Mate Interno opaco

W	⊖	∅ mm	↑ mm	⬠	lm	cd	✂	K	⌚	ON/OFF	📦	EAN	🏠
8	E14	35	97	E	40			2.300	1.000	4000	10	4000870 449080	449.08



Red Rojo Rosso



W	⊖	∅ mm	↑ mm	⬠	lm	cd	✂	K	⌚	ON/OFF	📦	EAN	🏠
25	E14	35	98	E	2				1.000		10	4000870 402214	402.21



Yellow Amarillo Giallo



W	⊖	∅ mm	↑ mm	⬠	lm	cd	✂	K	⌚	ON/OFF	📦	EAN	🏠
25	E14	35	97	E	83				1.000		10	4000870 402221	402.22



Green Verde Verde



W	⊖	∅ mm	↑ mm	⬠	lm	cd	✂	K	⌚	ON/OFF	📦	EAN	🏠
25	E14	35	98	E	7				1.000		10	4000870 402238	402.23



Blue Azul Blu



W	⊖	∅ mm	↑ mm	⬠	lm	cd	✂	K	⌚	ON/OFF	📦	EAN	🏠
25	E14	35	98	E	1				1.000		10	4000870 402245	402.24



Clear Transparente Trasparente



W	⊖	∅ mm	↑ mm	⬠	lm	cd	✂	K	⌚	ON/OFF	📦	EAN	🏠
3	E27	35	95	E	1				1.000		10	4000870 531006	531.00



Clear Transparente Trasparente



W	⊖	∅ mm	↑ mm	⬠	lm	cd	✂	K	⌚	ON/OFF	📦	EAN	🏠
3	E14	35	97	E	1				1.000		10	4000870 530009	530.00



Clear Transparente Trasparente



W	⊖	∅ mm	↑ mm	⬠	lm	cd	✂	K	⌚	ON/OFF	📦	EAN	🏠
3	E14	35	130	E	1				1.000		10	4000870 530030	530.03





Red Rojo Rosso



W	⊖	∅ mm	⋈ mm	◁	lm	cd	✂	K	⌚	ON/OFF	📦	EAN	📦
25	E27	55	95	E	2				1.000		6	4000870 400210	400.21
40	E27	55	95	E	2				1.000		6	4000870 400418	400.41



Yellow Amarillo Giallo



W	⊖	∅ mm	⋈ mm	◁	lm	cd	✂	K	⌚	ON/OFF	📦	EAN	📦
25	E27	55	95	E	83				1.000		6	4000870 400227	400.22
40	E27	55	95	E	65				1.000		6	4000870 400425	400.42



Green Verde Verde



W	⊖	∅ mm	⋈ mm	◁	lm	cd	✂	K	⌚	ON/OFF	📦	EAN	📦
25	E27	55	95	E	7				1.000		6	4000870 400234	400.23
40	E27	55	95	E	7				1.000		6	4000870 400432	400.43



Blue Azul Blu



W	⊖	∅ mm	⋈ mm	◁	lm	cd	✂	K	⌚	ON/OFF	📦	EAN	📦
25	E27	55	95	E	1				1.000		6	4000870 400241	400.24
40	E27	55	95	E	1				1.000		6	4000870 400449	400.44



Anti Insecta

Yellow Amarillo Giallo



W	⊖	∅ mm	⋈ mm	◁	lm	cd	✂	K	⌚	ON/OFF	📦	EAN	📦
60	E27	55	95	E	328				1.000		6	4000870 460603	460.60





Red Rojo Rosso



R80	W	⊖	∅ mm	↑ mm	□	lm	cd	↘	K	⌚	ON/OFF	📦	EAN	📦	
	60	E27	80	115	E	76		80		1.000		5	4000870 250617		250.61
	40	E27	63	102	E	40		35		1.000		6	4000870 230411		230.41
	25	E14	50	85	E	23		35		1.000		8	4000870 201213		201.21



Yellow Amarillo Giallo



R80	W	⊖	∅ mm	↑ mm	□	lm	cd	↘	K	⌚	ON/OFF	📦	EAN	📦	
	60	E27	80	115	E	279		80		1.000		5	4000870 250624		250.62
	40	E27	63	102	E	146		35		1.000		6	4000870 230428		230.42
	25	E14	50	85	E	89		35		1.000		8	4000870 201220		201.22



Green Verde Verde



R80	W	⊖	∅ mm	↑ mm	□	lm	cd	↘	K	⌚	ON/OFF	📦	EAN	📦	
	60	E27	80	115	E	84		80		1.000		5	4000870 250631		250.63
	40	E27	63	102	E	30		35		1.000		6	4000870 230435		230.43
	25	E14	50	85	E	33		35		1.000		8	4000870 201237		201.23



Blue Azul Blu



R80	W	⊖	∅ mm	↑ mm	□	lm	cd	↘	K	⌚	ON/OFF	📦	EAN	📦	
	60	E27	80	115	E	15		80		1.000		5	4000870 250648		250.64
	40	E27	63	102	E	7		35		1.000		6	4000870 230442		230.44
	25	E14	50	85	E	6		35		1.000		8	4000870 201244		201.24





Black light Luz negra Luce nera



W	⚡	∅ mm	↑ mm	⏏	lm	cd	⚡	K	🕒	ON/OFF	📦	EAN	📦	Price
75	E27	55	95						1.000		6	4000870 590706		590.70



Black light Luz negra Luce nera



W	⚡	∅ mm	↑ mm	⏏	lm	cd	⚡	K	🕒	ON/OFF	📦	EAN	📦	Price
75	E27	80	116						1.000		5	4000870 591703		591.70

R80

- ▶ Infrared
- ▶ Not suitable for medical applications.
- ▶ Approved for use in luminaires with protective glass only.
- ▶ Not for general lighting, only for special applications!
- ▶ Infrarrojo
- ▶ No apto para aplicaciones médicas.
- ▶ Solo se permite su uso en luminarias con cristal de protección.
- ▶ No apto para iluminación general, solo para aplicaciones especiales!
- ▶ Infrarosso
- ▶ Non per uso medico.
- ▶ Solo per apparecchi con vetro protettivo.
- ▶ Non adatto all'illuminazione generale, solo per applicazioni speciali!

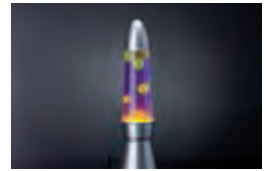

Infrared

Red Rojo Rosso



W	⚡	∅ mm	↑ mm	⏏	lm <sub>/90°</sub>	cd	⚡	K	🕒	ON/OFF	📦	EAN	📦	Price
40	E14	50	85	E	50		35	1.500	1.000	4000	8	4000870 829806	✓	new 829.80
50	E14	45	71	E	50		150	1.500	1.000	4000	8	4000870 829790	✓	new 829.79
25	E14	39	66	E	20		100	1.500	1.000	4000	8	4000870 829783	✓	new 829.78



Red Rojo Rosso



Infrared

W	⚡	∅ mm	↑ mm	⏏	lm <sub>/90°</sub>	cd	⚡	K	🕒	ON/OFF	📦	EAN	📦	Price
100	E27	95	134	E	64		80		1.000		4	4000870 829660		829.66
60	E27	80	115	E	26		80		1.000		5	4000870 829776		829.77
40	E27	63	102	E	25		35		1.000		6	4000870 829769		829.76





TV - Blue TV - Blau TV - Blu



W	E	∅ mm	↑ mm	□	lm	cd	↘	K	⌚	ON/OFF	📦	EAN	📦
15	E14	25	60	E	20				1.000		16	4000870 810101	810.10



300° Clear 300° Claro Trasparenza 300°



W	E	∅ mm	↑ mm	□	lm	cd	↘	K	⌚	ON/OFF	📦	EAN	📦
15	E14	22	50	E	85			2.300	1.000		16	4000870 820100	820.10
25	E14	25	55	E	125			2.200	1.000	4000	16	4000870 820117	820.11



300° Clear 300° Claro Trasparenza 300°



W	E	∅ mm	↑ mm	□	lm	cd	↘	K	⌚	ON/OFF	📦	EAN	📦
25	E14	45	75	E	185			2.300	1.000	4000	8	4000870 820209	820.20
40	E14	45	75	E	389			2.700	1.000		8	4000870 820407	820.40

300°/Opal 300°/Opale 300°/Opale



W	E	∅ mm	↑ mm	□	lm	cd	↘	K	⌚	ON/OFF	📦	EAN	📦
25	E14	45	78	E	160			2.700	1.000		8	4000870 106211	106.21
40	E14	45	78	E	300			2.700	1.000		8	4000870 106419	106.41



Clear Transparente Trasparente















W	E	∅ mm	↑ mm	□	lm	cd	↘	K	⌚	ON/OFF	📦	EAN	📦
15	BA15d	16	47	E	75			2.300	1.000		16	4000870 808108	808.10





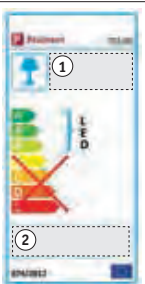





The energy-efficiency class label is shown as follows:

La etiqueta de clase de ahorro energético se representa del siguiente modo:

L'etichetta indicante la classe di efficienza energetica prevede la seguente rappresentazione:

	Example Ejemplo Esempio	①  Luminaires Lámpara Dispositivo	②  Bulbs Luminaria Lampadina
	<p><b>Arctus</b> </p> <p>max. 60 W, E27 230 V ∅80 ∅275 mm EAN 4000870 703458 <b>703.45</b></p>	<p>This luminaire is compatible with bulbs of the energy classes <b>A<sup>++</sup>-E</b>.</p> <p>Esta lámpara es compatible con luminarias de las clases <b>A<sup>++</sup>-E</b>.</p> <p>Questo dispositivo è compatibile con lampadine delle classi energetiche <b>A<sup>++</sup>-E</b>.</p>	
	<p><b>Futura</b> </p> <p>incl. 2x3,5 W, GU10, </p> <p>230 V ∅150 ∅275 ∅80 mm EAN 4000870 601792 <b>601.79</b></p>	<p>This luminaire is compatible with bulbs of the energy classes <b>A<sup>+</sup>-E</b>.</p> <p>Esta lámpara es compatible con luminarias de las clases <b>A<sup>+</sup>-E</b>.</p> <p>Questo dispositivo è compatibile con lampadine delle classi energetiche <b>A<sup>+</sup>-E</b>.</p>	<p>This luminaire is sold with a bulb of the energy class <b>A</b>.</p> <p>Esta luminaria se vende con una bombilla de la clase energética <b>A</b>.</p> <p>Il dispositivo è venduto con una lampadina di classe energetica <b>A</b>.</p>
	<p><b>Orbit</b> </p> <p>incl. 1x18,5 W 1100 lm, 3000 K 230 V ∅360 ∅57 mm EAN 4000870 703908 <b>703.90</b></p>	<p>This luminaire contains built-in LED lamps.</p> <p>Esta luminaria lleva lámparas LED incorporadas.</p> <p>Questo dispositivo è munito di lampade a LED integrate.</p>	<p>The lamps cannot be changed in the luminaire.</p> <p>Las lámparas de esta luminaria no son recambiables.</p> <p>Le lampade di questo dispositivo non sono sostituibili.</p>
	<p><b>HaloLED</b> </p> <p>incl. 4x20 W, GU4,  / 3x1,5 W 4x167 lm, 2900 K ∠ 30°, 500 cd 230/12 V, 105 VA ∅160 mm 2,5 mm<sup>2</sup> ∅12 m EAN 4000870 940709 <b>940.70</b></p>	<p>This luminaire contains built-in LED lamps and has sockets for bulbs of the energy classes <b>B-D</b>.</p> <p>Esta luminaria lleva lámparas LED incorporadas y contiene casquillos para bombillas de las clases energéticas <b>B-D</b>.</p> <p>Questo dispositivo è munito di lampade a LED integrate e di attacchi per lampadine di classi energetiche <b>B-D</b>.</p>	<p>This luminaire is sold with a bulb of the energy class <b>C</b>.</p> <p>Esta luminaria se vende con una bombilla de la clase energética <b>C</b>.</p> <p>Il dispositivo è venduto con una lampadina di classe energetica <b>C</b>.</p>

	Example Ejemplo Esempio	③  Bulbs Luminaria Lampadina															
	<table border="1" data-bbox="304 1729 619 1854"> <tr> <td></td> <td>∅ mm</td> <td>3 mm</td> <td></td> <td>lm</td> </tr> <tr> <td>E27</td> <td>66</td> <td>130</td> <td>A</td> <td>820</td> </tr> <tr> <td>E27</td> <td>60</td> <td>110</td> <td>A</td> <td>500</td> </tr> </table>		∅ mm	3 mm		lm	E27	66	130	A	820	E27	60	110	A	500	<p>Energy-efficiency class: <b>A</b></p> <p>Clase de ahorro energético: <b>A</b></p> <p>Classe di efficienza energetica: <b>A</b></p>
	∅ mm	3 mm		lm													
E27	66	130	A	820													
E27	60	110	A	500													

Products without specification of the energy-efficiency class are not included in the application area covered by EU Regulation 874/2012.

Los productos sin indicación de la clase de ahorro energético se salen del ámbito de aplicación del reglamento europeo 874/2012.

I prodotti che non recano l'indicazione della classe di efficienza energetica non rientrano nel campo di applicazione del regolamento UE 874/2012.

Socket – Shape – Lighting equipment  
 Portalámparas – Modelo – Tecnología  
 Base – Forma – Soluzione illuminotecnica

 <b>E27</b>	  <b>LED</b>  <b>Energy Saver</b>  <b>Halogen 230V</b> <b>Classic</b>	 <b>GU10</b>	  <b>LED</b>  <b>Energy Saver</b>  <b>Halogen 230V</b>
 <b>E14</b>	  <b>LED</b>  <b>Energy Saver</b>  <b>Halogen 230V</b> <b>Classic</b>	 <b>GZ10</b>	  <b>Halogen 230V</b>
 <b>B22d</b>	  <b>Halogen 230V</b>	 <b>G4</b>	  <b>LED</b>  <b>Halogen 12V</b>
 <b>BA15d</b>	 <b>Classic</b>	 <b>GY6,35</b>	  <b>LED</b>  <b>Halogen 12V</b>
 <b>GU4</b>	  <b>LED</b>  <b>Halogen 12V</b>	 <b>G9</b>	  <b>LED</b>  <b>Halogen 230V</b>
 <b>GU5,3</b>	  <b>LED</b>  <b>Halogen 12V</b>	 <b>R7s</b>	  <b>LED</b>  <b>Halogen 230V</b>



## Lumen comparison Comparativa de lúmenes Comparazione luminosità

Paulmann LED lamps consume at least 80% less power than conventional incandescent light bulbs.

They meet the requirements of efficiency classes A, A+ or A++.

For example, the LED lamp 282.98 with efficiency class A+ can replace a 60 W incandescent light bulb. For the same brightness, however, it consumes only 9.5 watts.

Las lámparas LED de Paulmann ahorran al menos un 80 % del consumo de energía de una lámpara incandescente convencional.









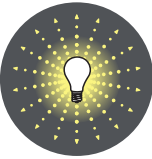

Cumplen los requisitos del grado de eficiencia A, A+ o A++.

Por ejemplo, la lámpara LED 282.98 con el grado de eficiencia A+ sustituye a una lámpara incandescente de 60 W. Suministra la misma luminosidad, pero con un consumo de tan solo 9,5 vatios.

Le lampadine LED Paulmann consentono di risparmiare almeno l'80% della potenza assorbita di una normale lampadina a incandescenza.

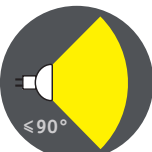
Soddisfano i requisiti della classe di efficienza A, A+ o A++.

Ad esempio la lampadina a LED 282.98 con una classe di efficienza A+ sostituisce una lampadina a incandescenza da 60 W. Con la stessa luminosità consuma soltanto 9,5 Watt.

	Lighting technology Luminotecnica Soluzione illuminotecnica	(Incandescent) lamp watts Lámpara (incandescente) vatios Lampadina (a incandescenza) Watt	LED brightness in lumen Luminosidad LED en lúmenes Luminosità LED in Lumen
Omnidirectional lamps Projectores omnidireccionales Luci omnidirezionali 	Classic incandescent light bulb Lámpara incandescente clásica Lampadina a incandescenza classica E14, E27, GU10 	15 W	140 lm
		25 W	250 lm
		40 W	470 lm
		60 W	806 lm
		75 W	1055 lm
		100 W	1521 lm
Halogen 230V G9, E27, R7s 	Halogen 230V G9, E27, R7s 	25 W	250 lm
		40 W	470 lm
		60 W	806 lm
Halogen 12V G4, GY6,35 	Halogen 12V G4, GY6,35 	5 W	45 lm
		10 W	90 lm
		20 W	190 lm
		35 W	390 lm
		50 W	630 lm
Reflector lamps Lámparas con reflector Riflettori 	Halogen 230V E14, E27, GU10 	25 W	125 lm
		35 W	200 lm
		50 W	300 lm
Halogen 12V GU4, GU5,3 	Halogen 12V GU4, GU5,3 	10 W	80 lm/90 lm (GU4/GU5,3)
		20 W	160 lm/180 lm (GU4/GU5,3)
		35 W	300 lm
		50 W	540 lm

LED instead of halogen – replacing high-voltage lamps (230 V):

LED en lugar de halógeno – sustitución en lámparas de alto voltaje (230 V):

LED al posto delle alogene - sostituzione della lampadine ad alto voltaggio (230V):

- |  |  |  |
|--|--|--|
| 1. Select the desired design.  | 1. ¡Seleccione el diseño que desee!  | 1. Selezionate la forma desiderata!  |
| 2. Find your socket type.  | 2. ¡Busque su casquillo!   | 2. Individuate l'attacco giusto!   |
| 3. Should the lamp be dimmable?  | 3. ¿La lámpara debe ser regulable?   | 3. La luce deve essere regolabile?   |
| 4. Select the desired brightness (watts/ lumen). Please pay attention to the minimum transformer load. | 4. Seleccione la claridad deseada (vatios/ lumen). Tenga en cuenta la carga mínima en transformadores. | 4. Selezionate la luminosità desiderata (watt/ lumen). Considerate il carico minimo dei trasformatori. |
| 5. Which luminous colour should the lamp have?   | 5. ¿Qué color de luz debe tener su lámpara?  | 5. Quale deve essere il colore della luce della lampadina?   |

LED instead of halogen – replacing low-voltage lamps (12V):  
 LED en lugar de halógeno – sustitución en lámparas de bajo voltaje (12 V):  
 LED al posto delle alogene - sostituzione della lampadine a basso voltaggio (12V):

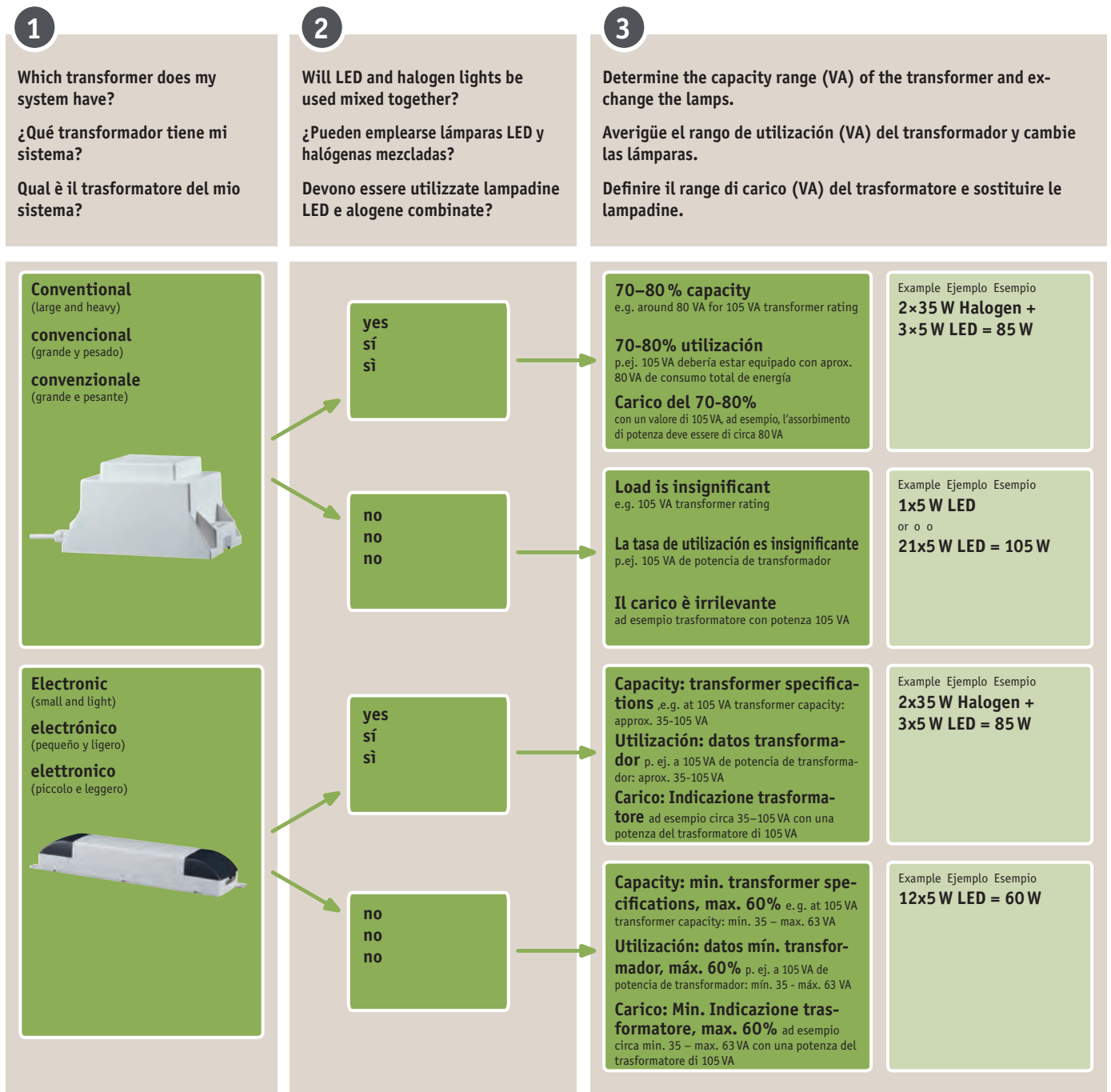

The value of 1 VA (Volt-ampere) in the transformer rating corresponds to the value of 1 W (watt) in the rated power consumption of the lamps.  
 El valor de 1 VA (voltamperios) en la norma de potencia de transformadores corresponde a 1W (vatío) de consumo de energía de las lámparas.  
 Il valore di 1 VA (voltampere) nell'indicazione della potenza del trasformatore corrisponde a 1 W (watt) di potenza assorbita delle lampadine.

Transformer for LED: the universal solution  
 Transformador para LED: la solución universal  
 Trasformatore per LED: la soluzione universale



If the new LED lamps do not meet the minimum transformer load, we recommend a new electronic transformer which consumes power of 0-40 watts (with LED). Item no. 977.67

Si los nuevos LED no alcanzan la carga mínima del transformador, le recomendamos un nuevo transformador eléctrico, que acepte potencia de 0-40 vatios (con LED) Art. n° 977.67

Se le nuove lampadine LED non raggiungono il carico minimo del trasformatore, si consiglia l'utilizzo di un nuovo trasformatore elettronico che assorbe la potenza di 0-40 watt (con i LED). Codice: 977.67



## Dimmer identification Identificación del regulador Marcatura dimmer

When installing a luminaire you have to find the right dimmer for the right lamp.

En la instalación se debe combinar el regulador correcto con la lámpara/luminaria correcta.

In un'installazione, il dimmer deve essere adatto alla lampadina / luce.

The letters (**R, L, C, LED...**) or combinations of those letters indicate the types of dimmers, transformers and lamps.

Los distintivos (**R, L, C, LED...**) o sus combinaciones definen los reguladores, los transformadores y las lámparas.

I codici (**R, L, C, LED...**) o le relative combinazioni definiscono dimmer, trasformatori e lampade.

When choosing a dimmer, the letters on the dimmer must correspond to those on the transformer or the lamp.

Para elegir el regulador correcto, los respectivos distintivos del regulador, el transformador o la lámpara deberán coincidir.

Per la scelta del dimmer più adatto, i codici presenti sul dimmer, sul trasformatore o sulla lampada devono coincidere.

- LED products require an LED dimmer which can be either a LEADING-edge



or a TRAILING-edge



dimmer.

(Letters **LED, HV-LED, LEDi**)

- Para los productos LED, necesita un regulador LED de corte de inicio de fase



o bien de corte de final de fase



(distintivos **LED, HV-LED, LEDi**)

- Per le lampade a LED è necessario un dimmer LED ad anticipo di fase



o a ritardo di fase



(Codice **LED, HV-LED, LEDi**)

- 12 V halogen lamps with an electronic transformer normally require a TRAILING-edge dimmer



(**R, C**)

- Para lámparas halógenas de 12 V con transformador electrónico, normalmente un regulador de corte de final de fase



(**R, C**)

- Normalmente con le lampadine Halogen 12V con trasformatore elettronico viene impiegato un dimmer a ritardo di fase



(**R, C**)

- 12V halogen bulbs with a conventional transformer require a LEADING-edge dimmer.



(**R, L**)

- Para lámparas halógenas de 12 V con transformador convencional, un regulador de corte de inicio de fase.



(**R, L**)

- Per le lampadine Halogen 12V con trasformatore tradizionale, un dimmer ad anticipo di fase.



(**R, L**)

- Any dimmer can be used with 230 V incandescent and halogen bulbs.



(**R / R, L / R, C / R, L, C**)

- Las lámparas incandescentes y las lámparas halógenas de 230 V pueden regularse con cualquier regulador.



(**R / R, L / R, C / R, L, C**)

- Le lampadine a incandescenza e le lampade alogene 230V possono essere dimmerate con qualsiasi dimmer.



(**R / R, L / R, C / R, L, C**)



**Cable cross-sections 12 V**  
**Secciones transversales del conductor 12 V**  
**Sezioni dei cav 12 V**

Determination of the cable cross-section  
 Determinación de la sección transversal del conductor  
 Determinazione della sezione del cavo

Light output Potencia de lámpara Potenza della lampada	Cable length Longitud del conductor Lunghezza del cavo				
	2,5 m	5,0 m	7,5 m	10,0 m	15 m
	Cable cross-section mm <sup>2</sup> Sección transversal del conductor mm <sup>2</sup> Sezione del cavo in mm <sup>2</sup>				
20 W	0,75	0,75	1,5	1,5	2,5
50 W	1	2,5	4	4	6
100 W	2,5	4	6		
150 W	4	6			
200 W	4				
250 W	6				
300 W	6				

Only for feed cables to distributions – not for wire systems.  
 Calculated for a 3 % voltage drop. Maximum cable length in the case of electronic transformers: 2 m.

Sólo para cables de entrada para distribuidores y no para sistemas de cables.  
 Calculado para una caída de tensión de un 3 %. Longitud máxima de conductor de 2 m para transformadores electrónicos.

Solo per cavi di distribuzione, non per sistemi a fune.  
 Calcolo eseguito per una caduta di tensione del 3 %. Per i trasformatori elettronici: lunghezza massima del cavo 2 m.

Recommended cable cross-sections for 12 V wire systems  
 Secciones transversales del conductor recomendadas para sistemas de cables de 12V  
 Sezioni raccomandate per i cavi di sistemi a fune a 12 V

Light output Potencia de lámpara Potenza della lampada	Wire length Longitud de cable Lunghezza della fune	
	< 5 m	> 5 – 15 m
	Cable cross-section in mm <sup>2</sup> Sección transversal del conductor mm <sup>2</sup> Sezione del cavo in mm <sup>2</sup>	
< 150 W	2,5	–
> 150 – 300 W	–	4





Wire systems may not have an output exceeding 300 W!  
 In the event of a higher output requirement, use circuit-cutters, thus forming two electric circuits! The appearance of the wire will be unaffected.

Los sistemas de cables deben tener una potencia inferior a 300 W!  
 Si se requiere más potencia, utilice un seccionador y cree así dos circuitos! Esto no repercute en la óptica del cable.

La potenza dei sistemi a fune non può superare i 300 W!  
 Se è necessaria una potenza superiore, utilizzare appositi sezionatori per formare due circuiti elettrici! L'effetto estetico della fune resta inalterato.

**Transformer load**  
**Carga del transformador**  
**Carico massimo del trasformatore**

How can transformers be fitted with an admissible load?  
 ¿Cómo se pueden dotar los transformadores con una carga fiable?  
 Come ottenere il carico massimo consentito per i trasformatori?

Trafo VA	 10 W	 20 W	 35 W	 50 W
60 VA	6 x 10 W	3 x 20 W	1 x 35 W 3 x 20 W	1 x 50 W
70 VA	7 x 10 W	3 x 20 W 1 x 10 W	2 x 35 W	1 x 50 W 1 x 20 W
80 VA	8 x 10 W	4 x 20 W	2 x 35 W 1 x 10 W	1 x 50 W 3 x 10 W
105 VA	10 x 10 W	5 x 20 W	3 x 35 W	2 x 50 W
150 VA	15 x 10 W	7 x 20 W 1 x 10 W	4 x 35 W 1 x 10 W	3 x 50 W
200 VA	20 x 10 W	10 x 20 W	5 x 35 W 1 x 20 W	4 x 50 W
210 VA	21 x 10 W	10 x 20 W 1 x 10 W	6 x 35 W	4 x 50 W 1 x 10 W
250 VA	25 x 10 W	12 x 20 W 1 x 10 W	7 x 35 W	5 x 50 W
300 VA	30 x 10 W	15 x 20 W	8 x 35 W 1 x 20 W	6 x 50 W





How bright is the lamp?  
 ¿Cómo de luminosa es la lámpara?  
 Quanto è luminosa la lampadina?

Brightness with omnidirectional spotlights  
 Luminosidad de proyectores omnidireccionales  
 Luminosità con luci omnidirezionali

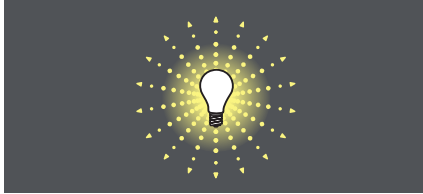

**The unit of measurement lumen (lm)** is specified with luminous flux the total amount of light that an omnidirectional lamp emits.

**La unidad lumen (lm)** de flujo luminoso indica la cantidad total de luz que emite una lámpara que irradie en todas direcciones.

**L'unità di misura lumen (lm)** e il flusso luminoso indicano la quantità complessiva di luce emanata da una lampadina.

Brightness with reflector lamps  
 Luminosidad de lámparas reflectoras  
 Luminosità con riflettori

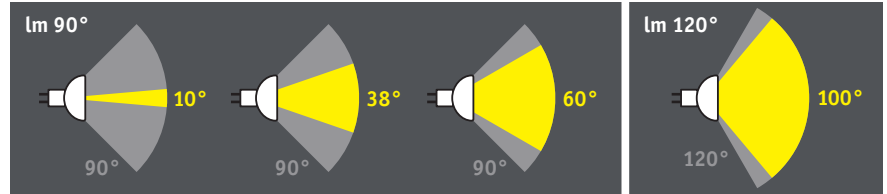

All reflector lamps with a beam angle of up to 90° are prescribed with luminous flux in a 90° angle and can therefore be compared. The brightness is measured outside of the 90° angle even though the actual beam angle is lesser.

All reflector lamps with a beam angle of 91° to up to 120° are prescribed with luminous flux in a 120° angle. These bulbs are not suitable for accent lighting.

All bulbs with a beam angle greater than 120° are considered „non-directional light“ and are prescribed with the luminous flux value (lumen, lm) that is determined in the complete 360° around the bulb.

The various units of measurement lumen (lm), lumen in the 90° angle (lm90°) and lumen in the 120° angle (lm120°) cannot be compared with each other.

Para posibilitar su comparación, en todas las lámparas reflectoras con un ángulo de irradiación de hasta 90° se indica el flujo luminoso en un ángulo de 90°. Se mide la luminosidad dentro del ángulo de 90°, aunque el ángulo de irradiación real sea menor.

En todas las lámparas reflectoras con un ángulo de irradiación de 91° hasta 120° se indica el flujo luminoso en un ángulo de 120°. Este tipo de luminaria no es adecuado para una iluminación de acentuación.

Todas las luminarias con un ángulo de irradiación mayor de 120° se consideran como „luz no dirigida“ y en ellas se indica el valor del flujo luminoso (lumen, lm) irradiado en todas direcciones (360°) alrededor de la luminaria.

Las diversas unidades de medida, lumen (lm), lumen en un ángulo de 90° (lm90°) y lumen en un ángulo de 120° (lm120°), no son comparables entre sí.

Tutti i riflettori con un angolo di irradiazione fino a max. 90° vengono contrassegnati con flusso luminoso a 90° e sono quindi comparabili tra loro. La luminosità viene misurata all'interno dell'angolo di 90°, anche se l'angolo di irradiazione effettivo è minore.

Tutti i riflettori con un angolo di irradiazione compreso tra 91° e max. 120° vengono contrassegnati con il valore di flusso luminoso a 120°. I corpi luminosi di questo tipo non sono adatti per l'illuminazione di accento.

Tutti i corpi luminosi con un angolo di irradiazione superiore a 120° sono considerati „luci non mirate“ e vengono contrassegnati con il valore di flusso luminoso (lumen, lm) calcolato su tutti i 360° intorno al corpo luminoso.

Le diverse unità di misura lumen (lm), lumen a 90° (lm90°) e lumen a 120° (lm120°) non sono comparabili tra loro.



Desired luminous colour?  
 ¿Qué color de luz se desea?  
 Quale colore della luce desidera?

## Candela

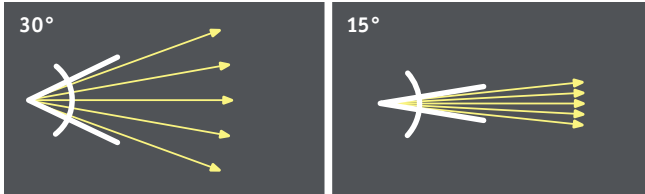

Broader beam angle, less light intensity  
 Mayor ángulo de irradiación, menor intensidad lumínica  
 Ampio angolo di irradiazione, intensità luminosa più ridotta

Narrower beam angle, greater light intensity  
 Menor ángulo de irradiación, mayor intensidad lumínica  
 Angolo di irradiazione più ridotto, elevata intensità luminosa

**The unit of measurement candela (cd)** specifies the light intensity of focused light as emitted by reflector lamps. Reflector lamps focus the luminous flux in a certain beam angle (specification in degrees). The narrower the angle, the greater is the focussing and the higher the candela value.

**La unidad candela (cd)** indica la intensidad luminosa de un haz de luz, como el generado por lámparas reflectoras. Las lámparas reflectoras concentran e intensifican el flujo luminoso en un ángulo determinado de irradiación (especificación en grados). Cuanto menor sea el ángulo, más intensa será la concentración y mayor el valor en candelas.

**L'unità di misura candela (cd)** indica l'intensità luminosa della luce in fasci, come ad esempio quella dei riflettori. I riflettori emettono la luce in fasci e rafforzano il flusso luminoso a un determinato angolo di irradiazione (indicato in gradi). Più ristretto sarà l'angolo, più potenti i fasci di luce e più elevato il valore candela.

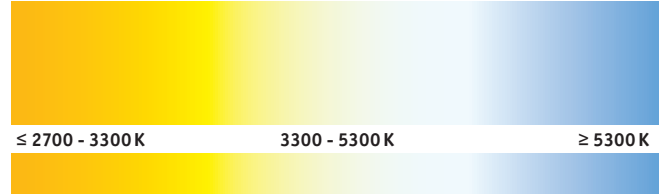

Warm white  
 Blanco cálido  
 Bianco caldo

Neutral white  
 Blanco neutro  
 Bianco neutro

Daylight white  
 Blanco de luz del día  
 Buco diurna

**The colour temperature** is specified by the unit Kelvin (K) and describes whether the white light is either a more warm yellow or a cold blue. Warm white light is like the afternoon daylight; it has a comforting and relaxing effect. Neutral white light is invigorating; daylight white encourages concentration.

**La temperatura de color** se especifica en Kelvin (K) y describe si la luz blanca es más bien de un amarillento cálido o de un azulado frío. La luz blanca cálida se asemeja a la luz del atardecer y produce un efecto confortable y relajante. La luz blanca neutral produce un efecto estimulante, la luz blanca diurna potencia la concentración.

**La temperatura di colore** viene espressa in Kelvin (K) e indica se la luce bianca tende più alle tinte calde del giallo o a quelle fredde del blu. La luce bianca calda ricorda la luce naturale sul finire della giornata, ricreando un'atmosfera piacevole e rilassante. La luce bianca neutra ha un effetto energizzante, mentre quella bianca naturale aiuta la concentrazione.



Safe areas Áreas de protección Zone di protezione

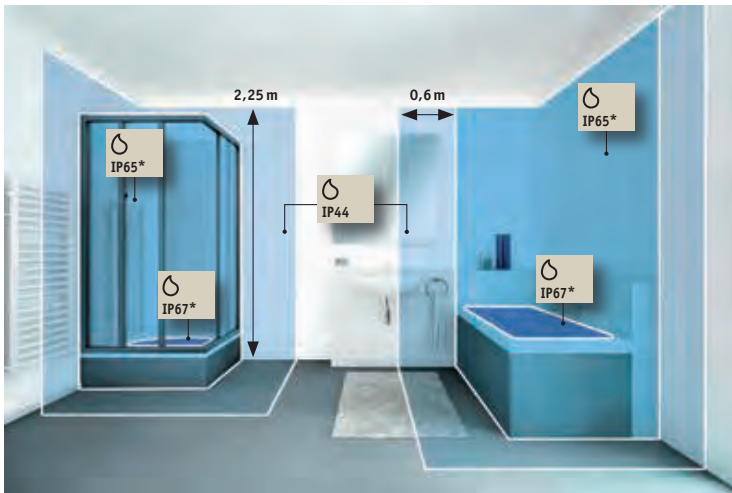

Water proof during temporary immersion  
(\* and 12 V low voltage protector)

Resistente al agua en caso de inmersión temporánea  
(\* y 12 V tensión baja de protección máx.)

Impermeabile all'immersione temporanea  
(\* e 12 V bassissima tensione di protezione)



Water jet protected against direct water jets  
(\* and 12 V low voltage protector)

Resistente al agua proyectada en caso de chorro directo  
(\* y 12 V tensión baja de protección máx.)

Protezione dai getti diretti d'acqua  
(\* e 12 V bassissima tensione di protezione)

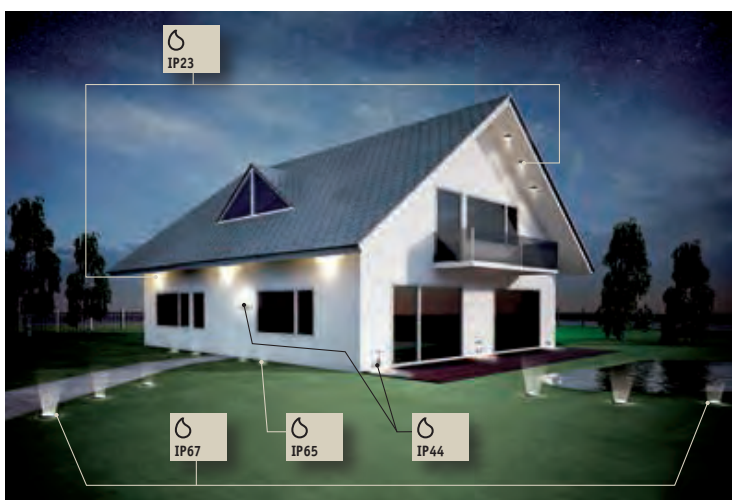

Splash protected  
Resistente a salpicaduras de agua  
Protezione dagli spruzzi d'acqua



Spray protected  
Resistente al agua atomizada  
Protezione da acqua nebulizzata



Safety classification IP 23 only applies to ceiling fittings.  
La clase de protección IP sólo es válida en las instalaciones en el techo.

Il grado di protezione IP è valido solo per il montaggio a soffitto.

**D Rooms with electrical systems acc. to DIN VDE 0100 T.701 (areas valid for ceilings up to 2.25 m)**

Only luminaires that are covered by a permanently attached glass plate may be installed in the ceiling or where the operation is low voltage protector.

The safety power source has to be outside the marked areas and there needs to be protection against direct contact of live parts. Cable and lines up to 5 cm deep in wall: only vertical layout and cable inlet in the back side of the luminaire.

**Countries outside Germany:** The dimensions, which must be adhered to exactly, as well as the evaluation of the areas must be conducted by a local electrician in accordance with national installation regulations.

**D Interiores con equipos eléctricos según DIN VDE 0100 T.701 (margen válido de hasta 2,25 m de altura)**

En el techo podrán empotrarse únicamente lámparas que estén cubiertas por una luna fija o que funcionen con baja tensión de protección.

La fuente de corriente de seguridad deberá hallarse fuera de la zona marcada y estar protegida contra el contacto directo de componentes conductores de tensión. Cables y conducciones hasta 5 cm bajo el enlucido: solamente tendido en vertical e introducción de cable en la cara trasera de la lámpara.

**Países fuera de Alemania:** Las medidas exactas que hay que observar, así como la evaluación de las zonas deberá efectuarse en conformidad con las normativas de instalación nacionales y por un electricista local.

**D Locali con impianti elettrici a norma DIN VDE 0100 T.701 (zone con un'altezza massima di 2,25 m)**

Gli apparecchi d'illuminazione possono essere incassati nel soffitto solo se sono coperti da una lastra di vetro fissa, oppure se sono alimentati con bassissima tensione.

La fonte della corrente di sicurezza deve essere disposta al di fuori delle zone contrassegnate e deve essere presente una protezione che impedisca il contatto diretto con i componenti attraversati dalla corrente. Cavi e conduttori fino a 5 cm sotto l'intonaco: solo posa verticale e inserimento del cavo nel lato posteriore dell'apparecchio d'illuminazione.

**Paesi diversi dalla Germania:** Le misure esatte da rispettare come anche la valutazione degli ambienti devono essere eseguite da un elettricista del luogo in conformità alle norme nazionali di installazione.



	☐		☐		☐
1Flame . . . . .	259	Conector . . . . .	168	Fleecy LED . . . . .	315,365
2Easy . . . . .	377-378	Connector . . . . .	168	Flexus I . . . . .	97
2Flame . . . . .	258-259	Connettore a spina . . . . .	384	Flexus II . . . . .	97
AR 111 . . . . .	452	Connettore . . . . .	168	Flickering candle . . . . .	473
Ace . . . . .	226	Coppa da incasso . . . . .	383	Floor Profil 1m . . . . .	216
Adaptador E27 - GU10 . . . . .	465	CosyLight . . . . .	467-468,473	Floor recessed luminaires . . . . .	240-244,248-249
Adaptador . . . . .	166,382,384-385	Crecimiento de plantas . . . . .	424	Foco de pinza . . . . .	96
Adapter E27 GU10 . . . . .	465	Crescita di piante . . . . .	424	Focus LED . . . . .	315
Adapter . . . . .	166,382,384-385	Crown mirror . . . . .	430,438,440,444	Forno . . . . .	477
Adattatore E27 - GU10 . . . . .	465	Cubeline . . . . .	235	Frame . . . . .	103
Adattatore . . . . .	166,382,384-385	Cupula espejo . . . . .	430,438,440,444	Fridge . . . . .	450
Akzent . . . . .	462	Curvus . . . . .	95	Frigorifero . . . . .	450
Alargamiento . . . . .	253	DC Spot Lense . . . . .	125	Frigorífico . . . . .	450
Alimentación . . . . .	131,168	DaisyLED . . . . .	117	Galeria LED II . . . . .	97
Alimentazione . . . . .	131,168	Daz . . . . .	340	Galeria . . . . .	92-93
Altavoz . . . . .	427	Deco LED . . . . .	364	Garden Spot . . . . .	246
Altoparlante . . . . .	427	DecoBeam . . . . .	18	Gate . . . . .	357
AmbientLED . . . . .	255	DecoDice . . . . .	345	Gesa . . . . .	96
Anello di montaggio . . . . .	278	DecoDot . . . . .	345	Giba . . . . .	83
Anello elastico . . . . .	385	DecoPipe . . . . .	436,455,464	Glint . . . . .	334,395
Anillo de montaje . . . . .	278	Decopipe . . . . .	436,455,464	Glow . . . . .	226
Anti Insecta . . . . .	474	Delta Profil . . . . .	215	Grid . . . . .	25
Apparecchi per montaggio a parete . . . . .	358-359,361-362,375	Detector de movimientos . . . . .	197,414	Ground spike . . . . .	245
Arandela de retención . . . . .	385	Deviatore . . . . .	130	Halo+ . . . . .	464
Areal LED . . . . .	272	Diamond . . . . .	422	HaloLED . . . . .	121
Aria . . . . .	311	Dice . . . . .	341	Helix . . . . .	113
Assistent II LED . . . . .	97	Disc . . . . .	456	Hemisphere . . . . .	101
Asta luminosa . . . . .	125	DiscLED I . . . . .	118	Hexa . . . . .	419,462
Attacco cavo . . . . .	130	DiscLED II . . . . .	118	HighPower LED . . . . .	371
Attacco . . . . .	384	Distribuidor . . . . .	253	Horno de cocer . . . . .	477
Bagel . . . . .	340	Distribution device . . . . .	253	House number . . . . .	257-258
Base set . . . . .	466	Distributore . . . . .	253	IcelLED I . . . . .	117,173
Basic system . . . . .	129	Diversor . . . . .	130	IcelLED II . . . . .	118,173
Basic . . . . .	126,380	Diverter . . . . .	130	Infrared lamp . . . . .	476
Bathroom light . . . . .	21-23,27-28,30-32,34-46	Dot . . . . .	341	Infrared . . . . .	476
Beam Fifty . . . . .	89-90	Double . . . . .	113	Infrarosso . . . . .	476
Beam Sixty . . . . .	89-90	Dress . . . . .	360	Infrarrojo . . . . .	476
Beam Thirty . . . . .	89-90	DressLight Battery . . . . .	229	Ivy . . . . .	25
Beam . . . . .	26	DressLight . . . . .	228	Ixa . . . . .	31
Biabo . . . . .	31	Drilled Alu . . . . .	311,313-314,327,372	Jenni . . . . .	84
Big Flame . . . . .	260	Drop . . . . .	46,107	JetLine . . . . .	235
Binari . . . . .	167	Duo Profil . . . . .	213	Jiggle . . . . .	230
Blacklight . . . . .	205,427,476	EcoPad Round . . . . .	10	Juego de Zócalo . . . . .	466
Blocco cavo . . . . .	131	EcoPad Square . . . . .	10	Juwel . . . . .	461-462
Block . . . . .	90	Edge . . . . .	271	Kiia . . . . .	83
Bloque de cable . . . . .	131	Ella . . . . .	85	Kite . . . . .	356
Bound . . . . .	20	Emisor de pared . . . . .	381	Klipp Klapp . . . . .	373
Bowl . . . . .	99	Encendedor . . . . .	458	LED Driver . . . . .	411-412
Butler . . . . .	97	Enchufe intermedio . . . . .	381	Lagoon . . . . .	106
Cable block . . . . .	131	Enjoy LED . . . . .	87	Lamp holder . . . . .	131
Cable connector . . . . .	130	Espiral . . . . .	456	Lampada a infrarossi . . . . .	476
Cable de tensión . . . . .	129	Estaca . . . . .	245	Lampada tubolare . . . . .	469
Cable . . . . .	129,384	Extension . . . . .	253	Lampadina da piastrella . . . . .	274-275
Calami . . . . .	94	Faccetto . . . . .	19	Launcher . . . . .	104
Carcasa incorporado . . . . .	383	Falima . . . . .	32	Layer . . . . .	339
Cardan . . . . .	121,123	Faretti da incasso a pavimento . . . . .	240-244,248-249	Leaf . . . . .	355
Cardano . . . . .	331	Feed . . . . .	131,168	Leonis . . . . .	29
Cavo di tensione . . . . .	129	Fennel . . . . .	125	LightSound . . . . .	390
Circlip . . . . .	385	Fiamma scintillante . . . . .	473	Linear lamps . . . . .	451
Circuit . . . . .	363	Fiammingo . . . . .	261	Linienlampen . . . . .	451
Clear . . . . .	101	Filament . . . . .	429,440,446,450	LinkLight . . . . .	236
Clip spot . . . . .	96	File lighting . . . . .	274-275	Liro . . . . .	312
Coin . . . . .	281-296,380,416	Finja . . . . .	96	Loudspeaker . . . . .	427
Colmar . . . . .	124	Fitting . . . . .	384	Luce di lettura . . . . .	94
Comet . . . . .	125	Flame . . . . .	261	Luce nera . . . . .	205,427,476
Conector enchufable . . . . .	384	Flame- color cálido . . . . .	261	Luce per specchi . . . . .	94
				Luci da bagno . . . . .	21-23,27-28,30-32,34-46

Luci per quadri . . . . .	91	Portalámparas. . . . .	131,384	Surface mounting ring . . . . .	278
Luminaria de baño . . . . .	21-23,27-28,30-32,34-46	Power Supply . . . . .	409	Suspension. . . . .	130,167
Luminaria de lectura. . . . .	94	Presa intermedia . . . . .	381	Suspensión. . . . .	130,167
Luminaria de superficie. . . . .	358-359,361-362,375	Profi. . . . .	219-221	TV . . . . .	471,477
Luminaria para baldosas . . . . .	274-275	Prolunga . . . . .	253	Teja Flex . . . . .	112
Luminaria para cuadros . . . . .	91	QPAR 111 . . . . .	424	Teja . . . . .	112
Luminaria pendular . . . . .	59,69,76	QR 111 . . . . .	462	Telecomando murale. . . . .	381
Luminarias empotrables en el suelo . . . . .	240-244,248-249	QuadLed . . . . .	116,172	Tension fitting kit . . . . .	130-131
Luminarias para espejos . . . . .	94	Quadro . . . . .	272,324,419,462	Testina a specchio . . . . .	430,438,440,444
Lumix . . . . .	225	Reading light . . . . .	94	Togo . . . . .	120,123
Lunar . . . . .	13-14	Recessed fitting . . . . .	383	Track . . . . .	167
Luz negra. . . . .	205,427,476	Remote controlled . . . . .	381	Transformador. . . . .	187,196,405-410,413
Lámpara infrarroja . . . . .	476	Riel . . . . .	167	Transformer . . . . .	187,196,405-410,413
Lámpara tubular . . . . .	469	Rilevatore di movimento . . . . .	197,414	Trasformatore . . . . .	187,196,405-410,413
MacLED . . . . .	116	Rolling . . . . .	335	TriX . . . . .	227
Macchina da cucire. . . . .	477	Roncalli II . . . . .	140,159	Trinca de cable . . . . .	130
MaxLED . . . . .	176-188,224	Rondo . . . . .	110	Tube lamp . . . . .	469
Maxiflood . . . . .	417,419,422,460-461,465	Rotate. . . . .	230-231	Tube . . . . .	47,107
Meli . . . . .	110	RoundMac . . . . .	116	Tumbler. . . . .	105
Meta. . . . .	119	Salt . . . . .	123	Twist Coin . . . . .	117
Mezzo . . . . .	119	Sara . . . . .	87	Two-Step . . . . .	20
Mic. . . . .	102	Saro . . . . .	85	URail . . . . .	134,139-140,148,154-155,158,163,165,167-169,171
Micro Line Dress . . . . .	373	Security . . . . .	460-461	USB-Stripes . . . . .	208-209
Micro . . . . .	247	SenseLight. . . . .	228	UpDownlight. . . . .	279
Milla. . . . .	85	Set Mac II . . . . .	122	Vane. . . . .	357
Mini LED . . . . .	273	Set Sheela . . . . .	124	Varilla de luz . . . . .	125
Mini electronic . . . . .	454,456	Set de montaje de elementos de tensión . . . . .	130-131	Vela de destellos . . . . .	473
Mini . . . . .	252	Set di montaggio a trazione . . . . .	130-131	Vilma . . . . .	84
MiniPlus . . . . .	250-251	Seven Color . . . . .	423	Vitrino . . . . .	95
Mirror light. . . . .	94	Sewing machine . . . . .	477	Wall transmitter . . . . .	381
Mobil Strip (4x1,5V AA excl.) . . . . .	208	Sheela. . . . .	120	WaterLED. . . . .	203-204
Motion detector . . . . .	197,414	Shell. . . . .	338-339	WaveLine. . . . .	238
Move LED. . . . .	86	SimpLED . . . . .	210-211	Whirl . . . . .	337,364
Máquina de coser . . . . .	477	Simplo . . . . .	95	Window . . . . .	103
Noora . . . . .	84	Sistema base . . . . .	129	WolbaLED. . . . .	109
Nova. . . . .	297	Sistema de base. . . . .	129	Work LED . . . . .	87
Numero civico. . . . .	257-258	SkyLight . . . . .	335-336	Xeta . . . . .	18
Número de casa. . . . .	257-258	Slice . . . . .	100	Yasmin . . . . .	109
OLED Bell. . . . .	80	Slide bar . . . . .	231	YourLED ECO . . . . .	190-191
Orbit. . . . .	16	Slimline Micro . . . . .	237	YourLED. . . . .	190-195,197-199,201
Outdoor light . . . . .	255-256	Slimline. . . . .	237	Zed LED . . . . .	86
Oven. . . . .	477	Smart Coin . . . . .	392-393	Zoccolo set. . . . .	466
PAR38. . . . .	425	SmartHome . . . . .	388-389,391,395-396,400	Zyli. . . . .	47,106
PIR-Sensor. . . . .	197	SmartLight. . . . .	231	Zylo . . . . .	111
PadLED Set. . . . .	8	Smartbulb . . . . .	427	a controllo remoto . . . . .	381
PadLED . . . . .	9-10	Smooth . . . . .	15	cavo . . . . .	129,384
Paletti . . . . .	245	SnapLED . . . . .	232	easyClick2 . . . . .	331
Panel Jet . . . . .	342	Snap . . . . .	16-17	inalámbrico . . . . .	381
Panel Line . . . . .	344	Sospensione. . . . .	130,167	light stick . . . . .	125
Panel Shower . . . . .	343	Space . . . . .	16	pendolare . . . . .	59,69,76
Panel . . . . .	342,344,346-353,394	Special Line LED Allround . . . . .	277	tension cable . . . . .	129
Pearly . . . . .	322	Special Line UpDownlight . . . . .	278		
Pendant. . . . .	59,69,76	Special Line Wall LED . . . . .	265		
Pendel Aufnahme. . . . .	62	Spice Salt. . . . .	123		
Phase . . . . .	119	Spice . . . . .	120		
Picture light. . . . .	91	Spiral . . . . .	456		
Pinja. . . . .	84	Spirale . . . . .	456		
Plainly LED. . . . .	314	Spot Mac II . . . . .	122		
Plane . . . . .	363	Spot Sheela . . . . .	124		
Plant growth . . . . .	424	Spot con clip. . . . .	96		
Plate . . . . .	125	Spotlight Georgia. . . . .	111		
Plattern . . . . .	356	Spotlight Turn. . . . .	108		
Plaza . . . . .	86	Square Profil . . . . .	218		
Plug adapter. . . . .	381	Squarelense . . . . .	102		
Plug connector . . . . .	384	Stage . . . . .	119,173		
Pole . . . . .	104	Starter . . . . .	458		
Pollerleuchte . . . . .	255-256	Stepino . . . . .	20		
Porta-lampada . . . . .	131	Surface mounted light . . . . .	358-359,361-362,375		





106.21	477	282.42	442	283.43	420	284.47	437	400.31	468	500.86	397	666.37	104
106.41	477	282.43	442	283.44	421	284.48	430	400.41	474	500.87	397	666.38	103
127.08	472	282.44	426	283.45	421	284.49	430	400.42	474	501.02	397	666.39	103
128.08	472	282.45	426	283.46	418	284.50	430	400.43	474	503.22	62	666.40	103
178.03	130	282.46	422	283.47	418	284.51	430	400.44	474	503.23	62	666.41	103
178.06	130	282.47	423	283.48	426	284.52	430	401.21	472	503.28	59	666.42	102
178.14	130	282.48	418	283.49	426	284.55	444	401.22	472	503.32	76	666.43	102
178.24	130	282.50	418	283.50	426	284.56	430	401.23	472	503.35	69	666.44	102
178.34	131	282.52	423	283.51	431	284.57	440	401.24	472	503.41	62	666.45	102
179.43	325	282.53	423	283.52	442	284.58	447	401.31	472	510.42	468	666.46	106
179.45	325	282.54	423	283.53	442	284.59	447	401.32	472	510.43	468	666.47	106
179.46	325	282.56	418	283.54	437	284.60	425	401.33	472	510.44	468	666.48	106
179.51	326	282.60	417	283.55	422	284.61	425	401.34	472	510.45	469	666.49	106
179.53	326	282.61	432	283.56	450	284.63	421	402.21	473	510.46	468	666.50	102
179.54	326	282.62	443	283.57	450	284.64	421	402.22	473	513.28	468	666.51	102
179.55	326	282.63	443	283.61	427	284.65	418	402.23	473	513.29	468	666.52	102
179.56	326	282.64	438	283.62	433	284.66	418	402.24	473	530.00	473	666.53	102
180.00	262	282.65	438	283.63	432	284.67	442	404000125	385	530.03	473	666.54	104
180.01	262	282.66	431	283.64	433	284.68	442	404000126	385	531.00	473	666.55	104
180.02	262	282.67	443	283.65	433	284.69	437	404000752	385	540.23	469	666.56	104
180.03	262	282.68	443	283.66	433	284.70	428	404000753	385	540.24	469	666.57	104
180.04	258	282.69	438	283.67	444	284.71	428	404001963	385	549.16	466	666.58	105
180.05	259	282.70	438	283.68	444	284.72	428	444.08	473	549.17	466	666.59	105
180.06	259	282.71	426	283.69	444	284.73	450	449.08	473	549.18	466	666.60	105
180.07	260	282.75	417	283.70	444	284.74	431	460.60	474	549.19	466	666.61	105
180.08	261	282.76	417	283.71	433	284.75	429	500.01	388	549.20	466	666.62	101
180.09	261	282.77	417	283.72	433	284.76	443	500.02	391	549.21	466	666.63	101
201.21	475	282.78	426	283.73	429	284.78	440	500.03	391	549.26	466	666.64	101
201.22	475	282.79	437	283.74	429	284.79	445	500.04	391	549.27	466	666.65	101
201.23	475	282.80	437	283.75	430	284.80	445	500.05	389	549.28	466	666.66	103
201.24	475	282.82	438	283.76	430	284.81	445	500.06	392	549.29	465	666.67	103
202000223	385	282.84	424	283.77	429	284.82	445	500.07	392	5774	328	666.68	103
202000224	385	282.85	422	283.78	429	284.83	445	500.08	390	5775	328	666.69	103
216	384	282.86	422	283.79	439	284.84	439	500.09	390	5792	329	666.70	108
217	384	282.87	417	283.80	439	284.85	441	500.10	390	5794	329	666.71	108
218.9	384	282.89	420	283.81	439	284.86	441	500.11	395	5796	329	666.72	108
228	385	282.90	420	283.82	444	284.87	441	500.12	395	590.70	476	666.74	108
229	385	282.91	431	283.83	444	284.88	441	500.13	395	591.70	476	666.75	108
230	383	282.92	431	283.84	444	284.89	452	500.14	395	600.04	127,151	666.76	108
230.41	475	282.93	442	283.85	444	284.90	452	500.15	395	600.06	127,151	666.78	110
230.42	475	282.94	442	283.86	440	284.92	435	500.16	389	600.07	127,151	666.79	110
230.43	475	282.95	442	283.87	440	284.93	434	500.17	389	600.08	127,151	666.80	110
230.44	475	282.96	442	283.88	440	284.94	434	500.18	389	600.09	127,151	666.81	110
232	199,254	282.97	426	283.89	440	284.95	434	500.19	388	600.11	126,150	666.82	109
233	385	282.98	426	283.90	446	284.96	434	500.20	388	600.12	127,151	666.83	109
236	383	282.99	421	283.91	446	284.97	434	500.21	395	600.15	127,151	666.84	109
237	254	283.00	421	283.92	446	284.98	435	500.26	394	600.53	127,151	666.85	109
250	383	283.01	418	283.93	446	284.99	435	500.27	394	600.55	127,151	666.86	110
250.61	475	283.02	451	283.94	446	285.00	445	500.28	394	601.62	113	666.87	110
250.62	475	283.03	451	283.95	446	285.01	445	500.29	394	601.98	113	666.88	110
250.63	475	283.04	451	283.98	426	285.02	445	500.34	394	601.99	113	666.89	110
250.64	475	283.05	451	283.99	448	285.03	445	500.35	394	602.00	113	666.90	109
280.00	418	283.06	432	284.00	448	285.04	445	500.36	394	603.24	128,152	666.91	109
280.07	423	283.07	432	284.01	448	285.05	435	500.37	394	603.25	128,152	666.92	109
280.08	423	283.08	432	284.02	448	285.06	435	500.38	391	603.26	128,152	666.93	111
280.10	423	283.10	432	284.03	448	285.07	434	500.39	391	603.27	128,152	666.94	111
280.11	422	283.11	443	284.04	448	285.08	434	500.43	396	603.28	105	666.95	111
280.13	423	283.12	443	284.05	448	285.09	420	500.44	396	603.29	105	666.96	111
280.48	422	283.13	437	284.06	449	285.10	420	500.45	399	603.30	105	666.97	112
280.49	418	283.14	437	284.07	449	285.13	435	500.46	399	603.31	105	666.98	112
280.91	417	283.15	432	284.08	427	285.14	424	500.47	399	603.49	128,152	666.99	112
281.10	450	283.16	443	284.09	421	285.15	452	500.48	399	603.50	128,152	667.00	112
281.11	450	283.17	443	284.10	421	285.17	428	500.49	399	603.51	128,152	667.01	112
281.12	420	283.19	438	284.11	450	285.18	428	500.50	398	603.52	128,152	667.02	112
281.33	424	283.20	431	284.12	450	285.21	449	500.51	398	603.77	100	667.03	112
281.70	432	283.21	443	284.13	450	285.22	449	500.52	401	603.78	100	667.04	112
281.71	432	283.23	438	284.14	450	285.23	449	500.53	401	603.79	100	667.05	112
281.72	432	283.24	438	284.15	451	285.24	449	500.54	401	603.80	100	667.06	111
281.73	432	283.25	419	284.16	451	285.25	449	500.55	401	603.81	100	667.07	111
281.74	432	283.26	419	284.17	451	285.26	449	500.56	401	603.82	99	667.08	111
281.75	443	283.27	436	284.18	421	314.65	469	500.61	401	603.83	99	667.09	111
281.76	443	283.28	436	284.23	429	314.66	469	500.62	401	603.84	99	667.10	47,106
281.79	420	283.29	417	284.24	440	314.67	469	500.64	400	603.85	99	667.11	47,106
281.88	426	283.30	419	284.25	446	314.68	469	500.65	400	603.86	99	667.12	47,106
282.08	431	283.31	429	284.33	421	400.17	468	500.66	402	660.52	83	667.13	47,106
282.10	442	283.32	429	284.34	421	400.18	468	500.67	396	666.18	113	667.14	46,107
282.11	447	283.33	444	284.35	436	400.21	474	500.68	400	666.19	113	667.15	46,107
282.12	447	283.34	444	284.36	436	400.22	474	500.71	401	666.20	113	667.16	46,107
282.17	427	283.35	433	284.39	452	400.23	474	500.72	401	666.21	113	667.17	47,107
282.19	422	283.36	417	284.40	452	400.24	474	500.73	401	666.30	101	667.18	47,107
282.24	421	283.37	441	284.41	452	400.25	468	500.80	398	666.31	101	667.19	47,107
282.27	420	283.38	420	284.42	452	400.26	468	500.81	398	666.32	101	700.18	19
282.28	426	283.39	443	284.43	452	400.27	468	500.82	397	666.33	101	700.21	20
282.32	423	283.40	431	284.44	425	400.28	468	500.83	397	666.34	104	700.23	20
282.37	418	283.41	424	284.45	425	400.29	468	500.84	397	666.35	104	700.24	20
282.38	424	283.42	420	284.46	420	400.30	468	500.85	397	666.36	104	700.30	20





701.28	18	703.65	43	705.01	229	706.56	13	708.08	226	796.06	72	800.59	464
701.29	18	703.66	43	705.08	28	706.57	184	708.09	218	796.07	72	800.60	464
701.74	126,150	703.98	227	705.09	27	706.58	184	708.10	218	796.08	67	800.62	464
701.79	85	703.99	228	705.10	201	706.59	181	708.11	225	796.09	67	800.63	464
701.96	191	704.00	235	705.11	201	706.60	181	708.12	225	796.10	72	800.64	464
701.97	191	704.01	235	705.12	201	706.61	178	708.13	225	796.11	73	800.65	464
701.98	190	704.02	235	705.67	183	706.62	178	708.14	225	796.12	67	800.66	464
701.99	196	704.03	228	705.68	180	706.63	178	708.23	187,409	796.13	73	808.10	477
702.00	196	704.04	228	705.69	180	706.64	178	708.24	187,409	796.14	68	810.10	471,477
702.01	196,409	704.05	238	705.70	183	706.65	178	708.26	227	796.15	69	820.10	477
702.02	194	704.06	238	705.71	180	706.66	178	708.27	176	796.16	75	820.11	477
702.03	198	704.07	201	705.72	180	706.67	178	708.28	177	796.17	77	820.20	477
702.04	197	704.08	201	705.73	183	706.68	178	708.29	176	796.18	75	820.40	477
702.08	193	704.09	216	705.74	187	706.69	181	708.30	177	796.19	75	829.66	476
702.09	193	704.10	216	705.75	187	706.70	181	708.38	38	796.21	76	829.76	476
702.10	192	704.13	203-204	705.76	187	706.71	181	708.39	38	796.22	78	829.77	476
702.15	197	704.14	203	705.77	176	706.72	181	708.40	46	796.23	79	829.78	476
702.21	213	704.15	203	705.78	177	706.73	184	708.41	46	796.24	79	829.79	476
702.45	86	704.16	203	705.79	176	706.74	184	708.42	46	796.25	78	829.80	476
702.47	199	704.17	203	705.80	177	706.75	181	708.55	219	796.26	77	831.15	460
702.48	86	704.18	203	705.81	176	706.76	181	708.56	219	796.27	79	831.16	460
702.51	197	704.19	203	705.82	177	706.77	188	708.57	222	796.28	59	831.17	460
702.52	190	704.26	34	705.83	176	706.84	188	708.58	220	796.29	59	831.18	460
702.53	190	704.27	34	705.84	177	706.85	188	708.59	220	796.30	51	831.19	460
702.54	191	704.28	191	705.85	180	706.86	25	708.60	222	796.31	52	832.09	462
702.55	191	704.29	191	705.86	180	706.87	25	708.61	222	796.32	52	832.23	462
702.56	191	704.30	190	705.87	183	706.88	25	708.62	221	796.33	53	832.25	462
702.57	191	704.32	15	705.88	180	706.89	25	708.63	221	796.34	52	832.33	460
702.61	215	704.33	15	705.89	180	706.90	25	708.64	11	796.35	53	832.44	461
702.62	215	704.34	15	705.90	198	706.91	26	708.65	11	796.36	52	832.45	461
702.63	215	704.35	228	705.91	196	706.92	26	708.66	11	796.37	51	832.46	461
702.64	215	704.37	16	705.92	193	706.96	207	708.67	11	796.38	51	832.47	460
702.65	215	704.38	16	705.93	193	706.97	207	708.68	11	796.40	53	832.53	461
702.66	215	704.39	217	705.94	192	706.98	204	708.69	11	796.41	51	832.60	461
702.67	213	704.40	217	705.95	234	706.99	204	708.70	12	796.42	64	832.61	462
702.68	213	704.41	217	705.96	234	707.00	208	708.71	12	796.43	64	832.66	462
702.69	213	704.42	217	705.97	234	707.01	208	708.72	12	796.44	64	833.14	462
702.70	213	704.43	228	705.98	234	707.02	208	708.73	12	796.45	64	833.71	462
702.71	213	704.44	228	705.99	198	707.03	208	708.74	27	796.46	53	833.74	462
702.72	213	704.45	235	706.04	176	707.04	208	708.75	27	796.47	55	833.76	460
702.73	213	704.46	235	706.05	177	707.05	209	708.76	33	796.48	55	833.79	461
702.74	213	704.47	227	706.06	233	707.06	209	708.78	42	796.49	55	833.82	460
702.75	213	704.48	227	706.07	37	707.09	224	708.79	42	796.50	55	833.83	460
702.82	198	704.49	235	706.08	37	707.10	224	708.80	44	796.51	56	833.84	461
702.83	218	704.50	235	706.09	46	707.11	224	708.81	44	796.52	56	833.85	461
702.84	236	704.51	197,414	706.10	44	707.12	224	708.82	26	796.53	56	833.86	461
702.85	236	704.52	195	706.11	45	707.13	224	708.83	33	796.54	56	838.24	460
702.90	18	704.53	213	706.12	233	707.14	224	749.94	86	796.55	56	838.26	461
702.91	18	704.54	235	706.13	233	707.15	223	749.95	86	796.56	60	860.02	455
703.09	201	704.55	208	706.14	233	707.16	223	750.00	237	796.57	60	860.03	457
703.10	201	704.56	208	706.15	187	707.17	223	750.50	237	796.58	60	860.07	456
703.11	201	704.57	208	706.16	187	707.18	223	750.60	237	796.59	60	870.01	467
703.12	201	704.58	191	706.17	187	707.19	223	750.80	237	796.60	60	870.03	467
703.17	193	704.59	191	706.18	187	707.20	18	751.06	237	796.61	73	870.05	467
703.18	193	704.60	190	706.19	188	707.21	18	751.08	237	796.62	67	870.07	467
703.19	192	704.61	195	706.21	188	707.22	29	751.13	237	796.63	76	875.58	467
703.20	193	704.63	40	706.22	19	707.23	29	751.21	237	796.64	51	875.60	467
703.21	193	704.64	40	706.23	185	707.24	29	770.10	84	796.65	79	875.63	467
703.22	192	704.65	28	706.24	185	707.25	29	770.15	85	796.82	65	875.69	467
703.28	205	704.66	28	706.27	186	707.26	197	770.18	85	796.83	65	875.72	467
703.29	205	704.67	28	706.28	186	707.27	197	770.25	87	796.84	54	875.74	467
703.30	213	704.68	45	706.29	185	707.32	17	770.29	84	796.85	54	875.75	467
703.34	198	704.69	41	706.30	185	707.33	17	770.31	84	796.86	54	875.76	467
703.35	194	704.70	41	706.33	186	707.34	17	770.32	83	796.87	54	875.77	467
703.36	193	704.71	41	706.34	186	707.35	16	770.37	84	796.88	67	875.85	467
703.37	193	704.72	35	706.35	230	707.36	16	789.72	211	796.89	61	875.90	467
703.38	192	704.73	35	706.36	230	707.37	17	789.73	211	796.90	61	880.14	456
703.41	32	704.74	35	706.37	231	707.76	226	789.74	211	796.91	61	880.15	456
703.42	32	704.75	35	706.38	231	707.77	226	789.75	211	796.92	61	880.56	454
703.43	30	704.76	35	706.39	231	707.90	21	789.76	211	800.11	471	883.13	454
703.44	30	704.77	35	706.40	231	707.91	22	789.77	211	800.12	471	883.19	454
703.45	30	704.78	35	706.41	14	707.92	22	789.78	210	800.13	471	883.21	454
703.46	30	704.79	35	706.42	14	707.93	22	789.79	210	800.15	471	883.23	456
703.47	30	704.80	207	706.43	14	707.94	23	789.80	210	800.16	469	883.38	455
703.48	31	704.81	207	706.44	14	707.95	23	793.91	87	800.17	469	884.24	458
703.49	45	704.86	199	706.45	14	707.96	23	793.92	87	800.18	469	884.32	457
703.50	39	704.87	199	706.46	14	707.98	21	795.31	81	800.30	464	884.40	457
703.51	39	704.88	198	706.47	14	707.99	21	795.32	81	800.31	464	884.45	457
703.54	39	704.89	198	706.48	13	708.00	182	795.33	81	800.32	464	884.46	457
703.58	40	704.90	198	706.49	13	708.01	182	795.34	81	800.33	464	884.47	457
703.59	38	704.92	37	706.50	13	708.02	179	795.35	81	800.34	460	884.48	457
703.60	42	704.94	36	706.51	13	708.03	179	795.37	81	800.40	464	884.84	458
703.61	42	704.95	36	706.52	13	708.04	31	796.00	68	800.41	464	885.08	458
703.62	43	704.98	232	706.53	13	708.05	31	796.01	69	800.42	464	885.13	458
703.63	43	704.99	229	706.54	13	708.06	32	796.04	69	800.43	465	885.14	456
703.64	43	705.00	232	706.55	13	708.07	226	796.05	68	800.44	465	885.15	458



885.19	458	925.33	316	935.51	273	936.43	379	938.25	263	939.58	293	950.73	169
885.20	458	925.34	316	935.52	369	936.44	379	938.26	263	939.59	293	950.77	173
885.21	458	925.35	337	935.53	369	936.45	379	938.27	277	939.60	293	950.81	10
885.36	458	925.39	312	935.54	369	936.46	379	938.28	277	939.61	295	950.86	167
885.41	458	925.41	312	935.55	369	936.47	333	938.29	277	939.62	295	951.17	140
885.44	458	925.43	337	935.56	369	936.48	332	938.30	277	939.63	295	951.24	171
885.45	458	925.87	363	935.58	367	936.49	308	938.31	277	939.64	295	951.25	171
885.49	458	925.94	377	935.59	366	936.50	308	938.32	416	939.65	295	951.26	167
885.50	458	925.95	377	935.60	366	936.51	307	938.33	253	939.66	295	951.36	167
885.53	458	926.20	327	935.61	355	936.52	307	938.34	243	939.67	293	951.40	168
885.54	458	926.21	314	935.62	355	936.53	307	938.35	416	939.68	293	951.54	140
885.58	458	926.25	313	935.63	356	936.54	307	938.36	416	939.69	295	951.55	159
885.60	458	926.28	313	935.64	358	936.55	317	938.37	416	939.70	295	951.77	145
885.61	458	926.73	314	935.65	358	936.56	317	938.39	380	939.71	296	951.82	150
885.62	458	926.86	322	935.66	359	936.57	317	938.42	392	939.72	296	951.83	150
885.63	458	926.93	341	935.67	359	936.58	317	938.43	392	939.73	292	951.85	164
885.64	458	926.94	341	935.68	361	936.59	317	938.44	392	939.74	292	951.86	164
890.20	454	926.95	341	935.69	363	936.60	317	938.45	318	939.75	292	951.92	172
892.39	456	926.96	341	935.70	363	936.61	297	938.46	318	939.76	292	951.93	172
892.40	456	927.02	340	935.71	363	936.62	297	938.47	318	939.77	294	951.94	173
894.09	455	927.04	340	935.72	361	936.63	298	938.48	318	939.78	294	951.95	173
894.11	455	927.05	345	935.73	362	936.64	298	938.49	318	939.79	294	951.96	173
894.19	455	927.06	345	935.74	365	936.69	245	938.50	318	939.80	294	951.97	173
894.39	456	927.09	316	935.75	365	937.00	278	938.57	282	939.81	294	951.98	166
920.15	320	927.10	342	935.76	365	937.26	324	938.58	282	939.82	294	951.99	166
920.16	320	927.13	316	935.77	365	937.28	324	938.59	282	939.83	294	952.04	139
920.26	321	927.26	338	935.78	315	937.30	331	938.60	282	939.84	294	952.05	158
920.27	321	927.27	339	935.79	315	937.31	331	938.61	282	939.85	296	952.20	125
920.28	322	927.28	339	935.80	362	937.40	270	938.62	282	939.86	296	952.21	9
920.29	322	927.33	345	935.81	375	937.41	270	938.63	284	940.03	129	952.22	9
920.31	356	927.34	345	935.82	357	937.42	270	938.64	284	940.79	119	952.23	8
920.32	357	927.35	337	935.83	357	937.43	270	938.65	284	940.80	119	952.24	8
920.33	357	927.81	289	935.84	356	937.44	270	938.66	284	940.81	119	952.25	9
920.34	349	927.82	289	935.86	371	937.45	270	938.67	284	940.82	119	952.26	9
920.35	347	927.83	289	935.87	372	937.46	242	938.68	284	940.88	116	952.27	140
920.36	348	927.84	291	935.88	371	937.51	246	938.69	283	940.89	116	952.28	140
920.37	346	927.85	291	935.89	372	937.53	272	938.70	283	940.90	118	952.69	139
920.38	349	927.86	290	935.90	335	937.54	248	938.71	283	940.91	116	952.70	159
920.39	347	927.87	290	935.91	334	937.56	274	938.72	283	940.92	117	952.71	139
920.40	348	927.88	290	935.92	334,395	937.57	274	938.73	283	940.93	118	952.72	159
920.41	346	927.89	342	935.93	303	937.58	272	938.74	283	940.94	117	952.73	139
920.58	350	927.90	343	935.94	303	937.59	248	938.75	285	940.95	117	952.74	145
920.59	350	927.91	343	935.95	303	937.61	385	938.76	285	940.96	129	952.75	162
920.60	351	927.92	344	935.96	303	937.62	385	938.77	285	940.97	125	952.78	139
920.61	350	927.93	344	935.97	303	937.64	245	938.78	285	941.05	116	952.79	158
920.62	350	927.94	380	935.98	303	937.65	258	938.79	285	941.06	116	952.80	140
920.63	351	927.95	380	935.99	303	937.67	249	938.80	285	941.07	116	952.81	159
920.64	352	928.46	288	936.00	303	937.68	279	938.81	287	941.08	116	952.82	171
920.65	352	928.47	288	936.01	304	937.69	257	938.82	287	941.09	118	952.83	159
920.66	353	928.48	288	936.02	304	937.72	251	938.83	287	941.10	118	952.84	9
920.67	352	928.49	288	936.03	304	937.74	242	938.84	416	941.11	116	952.85	140
920.68	352	928.97	297	936.04	304	937.75	243	938.85	416	941.12	117	952.86	159
920.69	353	928.98	297	936.05	304	937.76	244	938.86	380	941.13	117	952.91	135,155
920.70	350	928.99	297	936.06	304	937.77	244	938.87	380	941.14	118	952.92	135,155
920.71	350	929.00	297	936.07	304	937.81	260	938.88	286	941.15	118	952.93	135,155
920.72	351	929.01	300	936.08	304	937.82	256	938.89	286	941.16	117	952.94	169
920.73	350	929.02	300	936.09	305	937.83	250	938.90	286	941.17	117	952.95	169
920.74	350	929.03	299	936.10	305	937.84	250	938.91	286	941.18	117	952.96	169
920.75	351	929.04	299	936.11	305	937.85	250	938.92	286	941.20	120	953.07	141
920.76	352	929.05	331	936.13	305	937.86	250	938.93	286	941.23	120	953.08	160
920.77	352	929.06	331	936.14	305	937.87	240	938.94	286	941.24	120	953.09	136
920.78	353	929.07	336	936.15	305	937.88	241	938.95	286	941.25	121	953.10	156
920.79	352	929.08	338	936.17	306	937.89	241	938.96	282	941.26	121	953.11	171
920.80	352	929.09	310	936.18	306	937.90	251	938.97	282	941.27	121	953.15	136
920.81	353	929.10	310	936.19	306	937.91	257	938.98	284	941.28	121	953.16	156
920.87	370	929.11	309	936.21	306	937.96	240	938.99	284	941.29	80	953.17	170
920.88	370	929.12	309	936.22	306	937.97	240	939.00	283	941.30	80	953.18	170
920.89	370	929.13	309	936.23	306	938.05	385	939.01	283	941.31	124	953.19	136
920.90	370	929.14	309	936.25	301	938.06	385	939.02	285	941.32	122	953.20	156
920.91	370	929.15	310	936.26	301	938.07	268	939.03	285	941.33	122	953.21	137
920.92	370	929.16	310	936.27	301	938.08	263	939.36	393	941.34	122	953.22	157
920.93	392	929.17	337	936.28	302	938.09	263	939.37	393	941.35	122	953.23	137
920.94	392	929.18	311	936.29	302	938.10	384	939.38	393	941.36	124	953.24	157
920.95	392	929.19	314	936.30	302	938.11	255	939.39	393	941.37	123	953.25	168
920.96	390	929.20	313	936.31	303	938.12	255	939.40	393	941.38	124	953.26	168
920.97	348	929.21	313	936.32	303	938.13	255	939.41	393	941.39	123	953.27	168
920.98	346	935.11	360	936.33	303	938.14	255	939.42	281	941.40	125	953.28	168
920.99	348	935.12	360	936.34	303	938.15	255	939.43	281	941.41	126	953.29	141
921.00	346	935.14	360	936.35	379	938.16	256	939.44	281	941.42	121	953.30	160
921.01	319	935.25	373	936.36	379	938.17	416	939.45	281	941.43	124	953.31	142
921.02	319	935.26	373	936.37	379	938.19	416	939.46	281	941.44	123	953.33	160
921.05	319	935.41	372	936.38	379	938.20	380	939.47	281	941.45	123	953.35	143
922.09	335	935.43	364	936.39	304	938.21	269	939.48	416	941.46	123	953.36	160
925.05	382	935.44	371	936.40	304	938.22	269	939.55	293	941.47	123	953.37	144
925.06	382	935.47	362	936.41	304	938.23	253	939.56	293	950.16	165	953.38	144
925.30	311	935.50	273	936.42	304	938.24	253	939.57	293	950.17	165	953.39	144

953.40	144	954.53	138	965.28	377	977.15	407	979.055	129	988.68	252	997.43	378
953.41	144	954.54	138	968.31	168	977.20	407	979.057	129	988.69	252	997.44	378
953.42	161	954.55	139	968.33	167	977.23	411	979.059	129	988.70	252	998.10	336
953.43	161	954.56	158	968.34	167	977.24	411	979.067	129	988.71	252	998.12	368
953.44	161	954.57	145	968.54	167	977.25	407	979.069	129	988.75	241	998.14	368
953.45	161	954.58	162	968.85	168	977.26	411	979.32	408	988.76	240	998.15	368
953.46	161	954.59	142	968.86	168	977.27	411	979.41	408	988.77	241	998.16	265
953.47	10	954.61	142	971.1229	125	977.28	405	979.43	408	988.78	330	998.17	264
953.48	10	954.62	143	971.229	125	977.29	405	979.45	408	988.91	247	998.18	264
953.49	10	954.63	142	972.78	408	977.32	411	979.46	408	988.92	247	998.25	96
953.50	10	954.64	166	972.83	131	977.33	411	979.73	384	989.40	330	998.29	97
953.51	148	954.65	149	974.74	166	977.34	411	979.83	384	989.43	330	998.30	97
953.52	148	954.66	149	975.38	410	977.36	406	979.85	384	989.68	327	998.42	148
953.53	148	954.67	149	975.49	381	977.37	410	983.52	364	989.70	327	998.65	364
953.54	148	954.68	149	975.52	381	977.38	410	984.02	373	989.71	327	998.66	364
953.55	126,150	954.69	138	975.99	167	977.39	411	984.07	373	989.88	271	998.67	94
953.56	127,151	954.70	158	976.02	136	977.43	412	984.32	375	990.68	94	998.68	96
953.57	126,150	954.71	138	976.03	156	977.44	412	984.49	375	990.75	91	998.88	90
953.58	127,151	954.72	158	976.04	136	977.45	412	984.62	375	990.76	91	998.89	90
953.59	127,151	954.73	138	976.05	156	977.46	412	984.66	373	990.79	93	998.90	90
953.60	146	954.74	158	976.12	141	977.47	412	984.71	374	990.86	93	998.91	89
953.61	146	954.77	134	976.13	141	977.48	412	984.74	374	990.88	93	998.92	89
953.62	160	954.78	154	976.48	167	977.49	412	984.76	374	990.89	92	998.93	89
953.63	160	954.79	134	976.49	167	977.50	412	987.54	409	991.00	93	998.94	89
953.64	149	954.80	154	976.53	169	977.51	405	987.56	278	993.33	323	998.95	89
953.65	149	954.81	134	976.54	169	977.53	405	987.59	413	993.42	323	998.96	89
953.66	149	954.82	155	976.55	168	977.59	413	987.62	315	993.43	323	998.97	90
953.67	149	954.83	134	976.56	167	977.60	411	987.64	315	993.80	92	998.98	90
954.34	136	954.84	155	976.57	167	977.62	407	987.68	275	993.81	92	998.99	90
954.35	156	954.85	134	976.79	168	977.67	407	987.72	275	993.85	92	999.00	97
954.36	148	954.86	154	976.82	167	977.71	407	987.73	328	994.95	271	999.03	94
954.37	163	954.90	162	976.83	167	977.81	406	987.77	278	996.79	94	999.05	95
954.38	148	954.92	149	976.84	167	977.82	406	987.79	278	996.80	94	999.06	95
954.40	148	954.93	128,152	976.85	168	978.019	131	987.81	278	996.87	96	999.07	95
954.42	148	954.94	166	976.86	167	978.029	130	987.82	278	996.92	96	999.08	97
954.43	148	954.95	166	976.87	167	978.41	131	987.91	278	997.38	378	999.09	97
954.50	146	954.96	168	976.88	167	978.44	131	988.45	246	997.39	378	999.10	96
954.51	146	954.97	168	977.01	407	978.45	131	988.46	253	997.40	378		
954.52	138	954.98	167	977.03	410	979.047	129	988.47	254,414	997.42	378		



**A**

**ÖSTERREICH**

Paulmann Ges.m.b.H  
Linzerstrasse 89-91  
A-3003 Gablitz  
☎ +43 2231 66492  
✉ +43 2231 6649217  
info@paulmann.at

**AND**

**ANDORRA**

Paulmann Iluminación S.L.U.  
Ctra.Barcelona, nº 150 – Local 4  
ES- 08205 Sabadell (Barcelona)  
☎ +34 937279533  
✉ +34 937255953  
info@paulmann.es

**B**

**BELGIË**

VSA  
Hagelberg 29  
B-2440 Geel  
☎ +31 499 551460  
✉ +31 499 575795  
Paulmann@vanspijk.nl

**BG**

**БЪЛГАРИЯ**

Mankovski Ltd.  
16 Ana Feliksova Street  
Orchid Hills, bl. 2, fl. 4, ap. 14  
9000 Varna  
☎ +359 886654093  
i\_mankovski@abv.bg

**BIH**

**BOSNIA-HERCEGOVINA**

Mikrut D.O.O.  
Maciej Mikrut  
Ulica Ivana Pengova 18  
SI- 1230 Domzale  
☎ +386 31518153  
✉ +386 17219514  
mmikrut@paulmann.si

**CH**

**SCHWEIZ**

Puag AG  
Oberebenstrasse 51  
CH-5620 Bremgarten  
☎ +41/56-6488855  
✉ +41/56-6488850  
info@puag.ch

**CY**

**ΚΥΠΡΟΣ**

ΕΛΕΚΤΡΟΪΜΠΕΞ ΕΛΛΑΣ Α.Ε.  
Δερβενίων & Ποσειδώνος  
GR-14410 Μεταμόρφωση  
☎ +30 2102819783  
✉ +30 2102819385  
info@electroimpex.gr

**CZ**

**ČESKÁ REPUBLIKA**

Ing. Radek Brada  
Za Sídlištěm 450  
CZ-25241 Dolní Břežany  
☎ +420 602331140  
✉ +420 241416267  
brada.radek@volny.cz

**D**

**DEUTSCHLAND**

Paulmann Licht GmbH  
Quezinger Feld 2  
31832 Springe Völksee  
☎ +49 5041 998-0  
✉ +49 5041 998-119  
info@paulmann.de

**DK**

**DANMARK**

SB Trade ApS  
Rædersgade 3,1  
DK-8700 Horsens  
☎ +45 7023-2723  
✉ +45 7023-2703  
mb@sb.dk

**E**

**ESPAÑA**

Paulmann Iluminación S.L.U.  
Ctra.Barcelona, nº 150 – Local 4  
ES- 08205 Sabadell (Barcelona)  
☎ +34 937279533  
✉ +34 937255953  
info@paulmann.es

**EST**

**EESTI**

SIA Paulmann-Gaisma  
Gertrudes Iela 53-1A  
LV- 1011 Riga  
☎ +371 67280542  
✉ +371 67542413  
Paulmann@latnet.lv

**F**

**FRANCE**

Paulmann Lumière S.A.  
21, rue Desaix- CS 21076  
F-67452 Mundolsheim Cedex  
☎ +33 3 90203737  
✉ +33 3 90203757  
comm@paulmann.fr

**FIN**

**SUOMI (FINLAND)**

Hedengren Yhtiöt  
OY HedTec Ab  
Maenkimiehentie 4  
02780 ESPOO  
☎ +358 9 68288202  
✉ +358 9 673813  
lighting@hedtec.fi

**FL**

**LIECHTENSTEIN**

Puag AG  
Oberebenstrasse 51  
CH-5620 Bremgarten  
☎ +41/56-6488855  
✉ +41/56-6488850  
info@puag.ch

**GB**

**UNITED KINGDOM**

Light Source Europe Ltd.  
6 Great Western Business Park  
McKenzie Way  
Worcester  
WR4 9PT  
☎ +44 1905 22243  
✉ +44 1905 611263  
sales@lselighting.com

**GR**

**ΕΛΛΑΔΑ**

ΕΛΕΚΤΡΟΪΜΠΕΞ ΕΛΛΑΣ Α.Ε.  
Δερβενίων & Ποσειδώνος  
GR-14410 Μεταμόρφωση  
☎ +30 210 2819783  
✉ +30 210 2819385  
info@electroimpex.gr

**H**

**MAGYARORSZÁG**

DINOCOOP GmbH  
Radvány u. 24  
1118 Budapest XI  
☎ +36-1-3193064  
✉ +36-1-3193066  
dinocoop@dinocoop.hu

**HR**

**HRVATSKA**

Mikrut D.O.O.  
Maciej Mikrut  
Ulica Ivana Pengova 18  
SI- 1230 Domzale  
☎ +386 31518153  
✉ +386 17219514  
mmikrut@paulmann.si

**I**

**ITALIA**

TreEsse SRL  
Via Campanella 65  
50019 Sesto Fiorentino  
(Firenze)  
☎ +39 055 4252687  
✉ +39 055 4211598  
elena@treessesrl.com

**IS**

**ISLAND**

Johann Olafsson & Co  
Krokhals 3  
IS-110 Reykjavik  
☎ +354- 5331904  
✉ +354- 5331901  
jarni@olafsson.is

**L**

**LUXEMBOURG**

VSA  
Hagelberg 29  
B-2440 Geel  
☎ +31 499 551460  
✉ +31 499 575795  
Paulmann@vanspijk.nl

**LT**

**LIETUVA**

SIA Paulmann-Gaisma  
Gertrudes Iela 53-1A  
LV- 1011 Riga  
☎ +371 67280542  
✉ +371 67542413  
Paulmann@latnet.lv

**LV**

**LATVIJA**

SIA Paulmann-Gaisma  
Gertrudes Iela 53-1A  
LV- 1011 Riga  
☎ +371 67280542  
✉ +371 67542413  
paulmann@latnet.lv

**MK**

**MAKEDONIJA**

DPTUU „EL-LUKS“ DOOEL  
ul : Leninova br. 79  
MK-2400 Strumica  
☎ +389 75 301 109  
✉ +389 34 320 133  
info@el-lux.com.mk

**MNE**

**CRNA GORA**

HIDRO NEON DOO  
Ive Lole Ribara 13  
SRB-23232 Torak  
☎ +381-21-505 790  
✉ +381-21-520 156  
peraneon@eunet.rs

**N**

**NORGE**

Lyskomponenter AS  
Sagmyra 2A  
N-4624 Kristiansand S  
☎ +47 38003636  
✉ +47 38003639  
firmapost@lyskomponenter.no

**NL**

**NEDERLAND**

VSA  
De Scheper 402  
NL-5688HP Oirschot  
☎ +31 499 551460  
✉ +31 499 575795  
Paulmann@vanspijk.nl

**P**

**PORTUGAL**

Paulmann Iluminación S.L.U.  
Ctra.Barcelona, nº 150 – Local 4  
ES- 08205 Sabadell (Barcelona)  
☎ +34 937279533  
✉ +34 937255953  
info@paulmann.es

**PL**

**POLSKA**

„LŁ“ sp. z o.o sp. k.  
dawniej „Lange Łukaszk“  
Spółka jawna  
ul. Wrocławska 43, Byków  
55-095 Mirków  
☎ +48 71 39 80 800  
✉ +48 71 39 80 802  
paulmann@langelukaszuk.pl

**RO**

**ROMANIA**

Atrium Design SRL  
Str. Balciului, no.1  
Sector 2,  
RO-021501 Bucharest  
☎ +40 21 252 4653  
✉ +40 21 252 4654  
atrium@atrium.ro

**RUS**

**РОССИЯ**

Лайт Капитал 000  
ул.Выборгская д.16  
стр.1 оф.А809  
125212, г.Москва  
☎ +7 495 514-19-08  
✉ +7 495 514-19-08  
info@paulmann.ru

**S**

**SVERIGE**

Paulmann Licht GmbH  
Quezinger Feld 2  
D-31832 Springe  
☎ +49 5041 998-0  
✉ +49 5041 998-169  
info@paulmann.de

**SK**

**SLOVAKIA**

Ing. Radek Brada  
Za Sídlištěm 450  
CZ-25241 Dolní Břežany  
☎ +420 602331140  
✉ +420 241416267  
brada.radek@volny.cz

**SLO**

**SLOVENIJA**

Mikrut D.O.O.  
Maciej Mikrut  
Ulica Ivana Pengova 18  
SI- 1230 Domzale  
☎ +386 31518153  
✉ +386 172 19514  
mmikrut@paulmann.si

**SRB**

**REPUBLIKA SRBIJA**

HIDRO NEON DOO  
Ive Lole Ribara 13  
SRB-23232 Torak

☎ +381-21-505 790  
✉ +381-21-520 156  
peraneon@eunet.rs

**TR**

**TÜRKIYE**

Paulmann Licht GmbH  
Quezinger Feld 2  
D-31832 Springe  
☎ +49 5041 998-0  
✉ +49 5041 998-169  
info@paulmann.de



Product dimensions  
Dimensionado de artículos  
Dimensionamento degli articoli

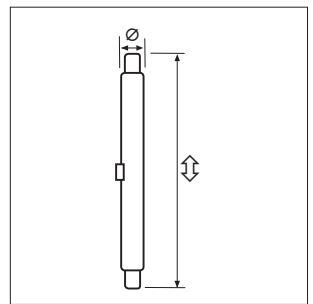
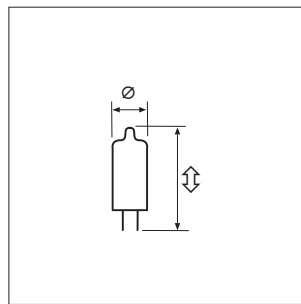
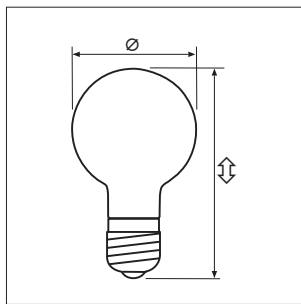
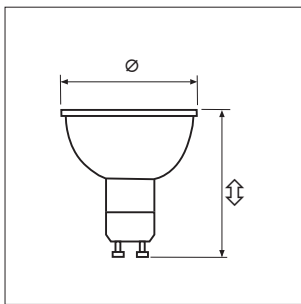
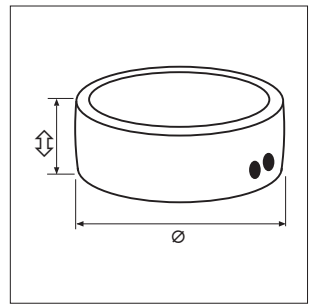
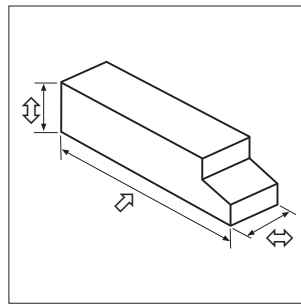
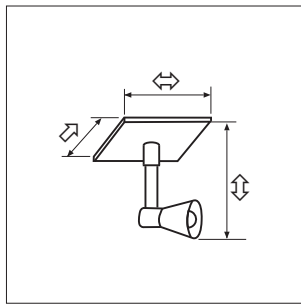
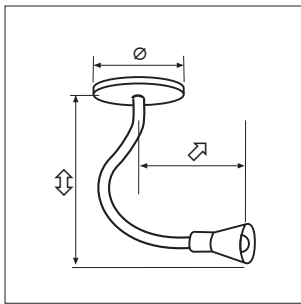
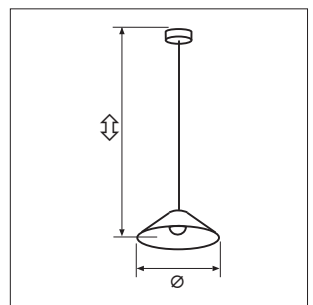
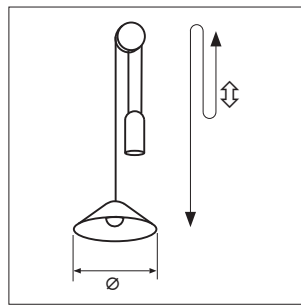
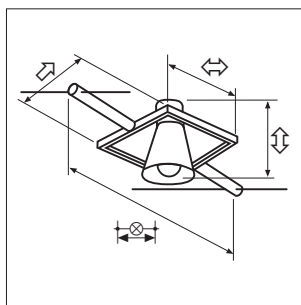
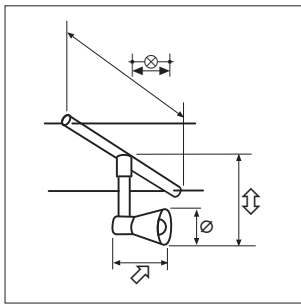
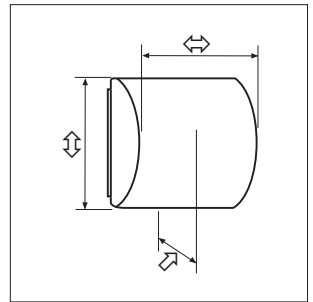
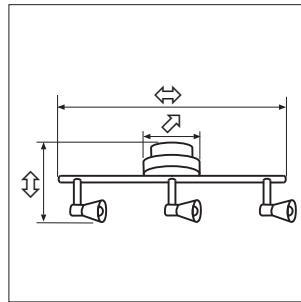
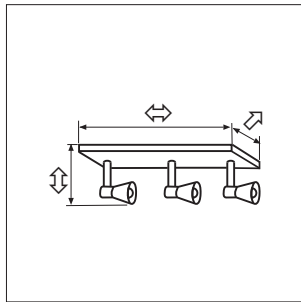
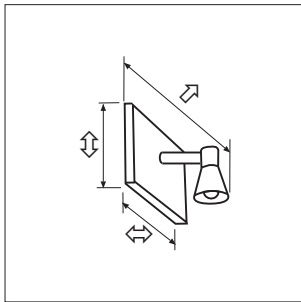
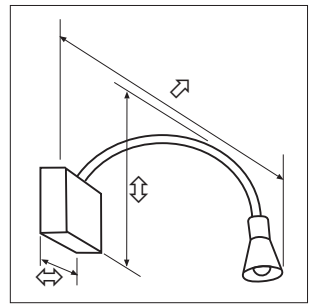
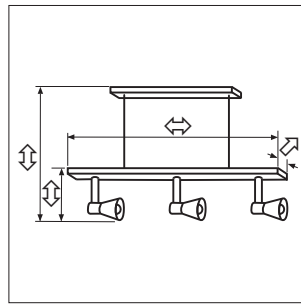
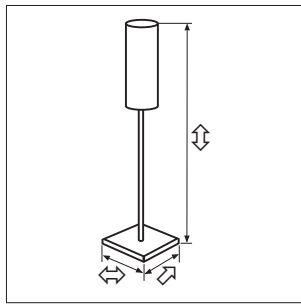
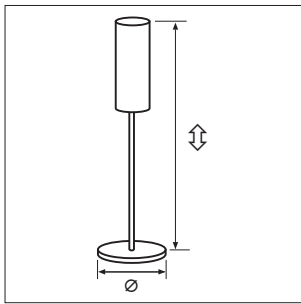





**GB**  
We guarantee all Paulmann products for 3/5 years. This guarantee does not cover bulbs.

**E**  
Todos los productos de Paulmann tienen una garantía de 3/5 años. Las bombillas están excluidas de la garantía.

**I**  
Tutti i prodotti Paulmann sono coperti dalla nostra garanzia di 3/5 anni. Tale garanzia non include gli apparecchi d'illuminazione.



Safety test marks issued by the Association of German Electrical Technicians (VDE) and the German Technical Monitoring Associations (TÜV). Paulmann is synonymous with optimum safety and quality. All our products comply with the European standards laid down. Even when safety tests are not mandatory, Paulmann products are tested by the VDE, TÜV or the Paulmann Quality Assurance department. These are marked accordingly in the product.

Símbolo de control de seguridad de VDE y TÜV. Paulmann equivale a seguridad y calidad. Todos nuestros artículos están fabricados según las normas europeas fijadas. Los productos de Paulmann se someten a inspección por el VDE, TÜV o control de calidad de Paulmann, incluso cuando no está estipulada. Los artículos están marcados de forma correspondiente en el catálogo.

Marchi di sicurezza del Verband Deutscher Elektrotechniker (associazione dei tecnici elettricisti tedeschi) e delle associazioni di controllo tecnico. Paulmann è sinonimo di qualità e massima sicurezza. Tutti i nostri articoli sono conformi alle vigenti normative europee. I prodotti Paulmann sono testati dal VDE, dal TÜV o dalla nostra unità interna di assicurazione qualità, anche nei casi in cui non è prescritto un collaudo di sicurezza obbligatorio. I test effettuati sono specificati nel catalogo.

150 VA

The VDE mark behind the transformer specification (e.g. C. 105 VA) refers only to the transformer, and not to the product.

El símbolo VDE detrás del transformador (p. ej. 105 VA) sólo se refiere al transformador y no al producto.

Il marchio VDE che segue l'indicazione del trasformatore (p. es. B. 105 VA) si riferisce esclusivamente al trasformatore, non al prodotto.

All illustrations and specifications regarding measurements, colours and the like may be subject to technical production margins of tolerance, and are not binding. We reserve the right to make changes to products at any time. We work on the basis of our Terms of Supply and Payment. We will be happy to supply these terms on request, or they can be viewed at [www.paulmann.com](http://www.paulmann.com).

Todas las ilustraciones y datos de dimensiones, color, etc. dependen de posibles tolerancias técnicas y de producción y no son vinculantes. Nos reservamos el derecho a modificaciones en los productos. Todo pedido implica la aceptación de nuestras condiciones de pago y suministro. Nos las puede solicitar o ver en [www.paulmann.com](http://www.paulmann.com)

Le illustrazioni e i dati possono presentare lievi differenze tecniche rispetto ai prodotti (dimensioni, colori, ecc.) e non sono vincolanti. Ci riserviamo di apportare modifiche ai prodotti in qualsiasi momento. La nostra attività si basa sulle nostre condizioni generali di fornitura e pagamento, che sono disponibili su richiesta oppure nel sito Internet [www.paulmann.com](http://www.paulmann.com).

832.xx

We recommend buying the replacement bulbs specified for the products in question.

Recomendamos la compra de todos los medios de iluminación indicados junto a los productos.

Raccomandiamo l'acquisto dei corpi illuminanti indicati per ciascun prodotto.



These items are the product of traditional craftsmanship. Colour and shape deviations as well as air pockets are therefore possible.

Estos artículos son un producto tradicional de artesanía, por lo que pueden presentar variaciones en color y forma, así como burbujas de aire.

Questo articolo è un prodotto artigianale. Sono pertanto possibili differenze di colori e forme e inclusioni d'aria.



Colour

Color

Colore









Material

























Material

Materiale





	Safety classification 2	Clase de protección 2	Grado di protezione 2
	Safety classification 3	Clase de protección 3	Grado di protezione 3
	Dichroic mirror	Reflector dicróico	Specchio per luce fredda
	Low pressure	Baja presión	Bassa pressione
	Product with a limited surface temperature	Producto con temperatura limitada en la superficie	Prodotto con temperatura superficiale limitata
	The bulb is only suitable for fitting to non-flammable materials.	La luminaria sólo debe instalarse en materiales no inflamables.	L'apparecchio d'illuminazione è idoneo al solo montaggio su materiali non infiammabili.
	IP safety classifications See page 493 for further details	Clases de protección IP Para más información, véase pág. 493	Gradi di protezione IP Per le spiegazioni vedi pagina 493
	Rust-proof	Inoxidable	Antiruggine
	2 brightness levels	2 niveles de claridad	2 livelli di luminosità
	Dusk sensor	Sensor crepuscular	Sensore crepuscolare
	RGB Multicolor colour change	RGB multicolor cambio de color	Cambio di colore RGB Multicolor
	LED colours red, green or blue	Color de LED rojo, verde o azul	LED colorato rosso, verde o blu
	Adjustable colours	Colores configurables	Colori impostabili
	Flashing	Intermitente	Lampeggiante
	Freeze function	Función Freeze	Funzione freeze
	Flashlight function	Función Flashlight	Funzione Flashlight
	Sound sensor	Sensor de sonido	Sensore di suono
	With switch	Con interruptor	Con interruttore
	With cable switch incl. plug	Con interruptor de cable, enchufe incl.	Completo di interruttore a cavo incl. connettore
	With touch dimmer	Con reguladores de luz táctiles	Con dimmer a sfioramento
	With dimmer	Con reguladores de luz	Con dimmer
	dimming	regulable	regolabile
	Bayonet coupling	cierre bayoneta	Attacco a baionetta
	With plug-in transformer	Con transformador de enchufe	Con trasformatore a spina
	Plug including earthing contact (Germany)	Enchufe con contacto de puesta a tierra (Alemania)	Connettore Schuko (Germania)
	With plug connector	Con conector	Con connettore a spina
	With remote control	Con mando a distancia	Con telecomando
	Motion detector with high frequency sensor	sensor de movimiento con sensor de alta frecuencia	Sensore di movimento ad alta frequenza
	Motion detector	sensor de movimiento	Sensore di movimento
	Motion detector with proximity sensor	sensor de movimiento con sensor de proximidad	Sensore di movimento con sensore di prossimità
	Battery, rechargeable battery, battery and rechargeable battery operation possible	Es posible su uso con pilas, con batería o con pila y batería	Sono possibili i funzionamenti a batteria, accumulatore e batteria + accumulatore
	Battery/rechargeable battery included	Pila / batería incluida	Batteria/accumulatore in dotazione
	Wall, floor and/or ceiling fitting	Montaje a pared, suelo y/o techo	Montaggio a parete, pavimento e/o soffitto
	Maximum load	Carga máx.	Carico max.
	Wire/rod distance	Distancia de cable/barra	Distanza fune/asta
	Base	Casquill	Zoccolo

lm	Lumen, luminous flux See page 480, 484 for further details	lumen, flujo luminoso Para más información, véase pág. 480, 484	Lumen, flusso luminoso Per le spiegazioni vedi pagina 480, 484
lm/90° lm/120°	Brightness with reflector lamps See page 484 for further details	Luminosidad de lámparas reflectoras Para más información, véase pág. 484	Luminosità con riflettori Per le spiegazioni vedi pagina 484
K	Kelvin, colour temperature See page 485 for further details	kelvin, temperatura de color Para más información, véase pág. 485	Kelvin, temperatura di colore Per le spiegazioni vedi pagina 485
cd	Candela (Lux) value at 1 m See page 485 for further details	Valor Candela (Lux) en 1 m Para más información, véase pág. 485	Valore Candela (Lux) su 1 m Per le spiegazioni vedi pagina 485
S	Dummy output See page 483 for further details	Potencia aparente Para más información, véase pág. 483	Potenza apparente Per le spiegazioni vedi pagina 483
	Easily fitted	Montaje simple	Facile montaggio
	Only for indoor use	uso sólo en interiores	Solo per interni
	Toroid transformer	Transformador toroidal	Trasformatore a nucleo toroidale
	Can be dimmed using leading edge dimmer. See page 482 for further details	Regulable con un reductor de corte de inicio de fase. Para más explicación véase la página 482	Variazione dell'intensità luminosa con dimmer di fase nella sezione di accensione. Per le spiegazioni vedi pagina 482
	Can be dimmed using trailing edge dimmer. See page 482 for further details	Regulable con un reductor de corte de fin de fase. Para más explicación véase la página 482	Variazione dell'intensità luminosa con dimmer di fase nella sezione di spegnimento. Per le spiegazioni vedi pagina 482
	Integrated spark protection	Protección contra interferencias integrada	Protezione radio integrata
	Integrated soft start	Softstart integrado	Avvio "soft" integrado
	Integrated short circuit protection	Protección contra cortocircuitos integrada	Protezione da corto circuito integrata
	Increased spike protection	Mayor protección contra perturbaciones	Maggiore protezione "anti-spike"
	Integrated fire protection	Protección contra incendios integrada	Protezione antincendio integrada
	Integrated overload protection	Protección contra sobrecarga integrada	Protezione da sovraccarico integrata
	Integrated re-startable temperature monitor	Sensor de temperatura reconectable integrado	riattivabile integrato
	Integrated temperature monitor and electronic fuse	Sensor de temperatura integrado y fusible electrónico	Termostato integrado e fusibile elettronico
	Integrated electronic fuse	Fusible electrónico integrado	Fusibile elettronico integrato
	Integrated fine-wire fuse	Fusible para baja intensidad integrado	Fusibile per correnti deboli integrato
	Self-service pack	Embalaje SB	Imballaggio "SB"
	Packaging unit	Unidad de embalaje	Unità d'imballaggio
	Energy-efficiency class	clase de ahorro energético	Classe di efficienza energetica
ON/OFF 	Cycles of operation	Ciclos de conmutación	Cicli di commutazione
	Lower power consumption, the same brightness	Menor consumo de corriente, igual luminosidad	Meno consumo elettrico, luminosità invariata
	Flicker-free quick start	encendido inmediato sin centelleo	Accensione immediata senza luce pulsante
	Service life	vida útil	Durata utile
	Service life, electronic ballast	vida útil reactancia electrónica	Durata utile alimentatore elettronico
	Not for general lighting, only for decorative purposes or special applications	No apto para iluminación general, solo para fines decorativos o aplicaciones especiales	Non per l'illuminazione generale, solo a fini decorativi o per applicazioni speciali
	Fabric cable	Cable textil	Cavo tessile
	Dimmable with Smart Home app	Regulable con la aplicación Smart Home	Dimmerabile con l'App Smart Home
	Tunable white	Blanco ajustable	Bianco regolabile
	OLED	OLED	OLED
	With USB plug	Con conector USB	Con connettore USB
	With USB connection	Con conexión USB	Con collegamento USB



